



# Millard®

GLOBAL QUALITY FILTERS

## MEXICO 2017

CATÁLOGO DE FILTRACIÓN

VEHÍCULOS LIVIANOS



# GLOBAL QUALITY

---

Millard® es la marca europea especializada en la fabricación de sistemas de alta tecnología en filtración para la industria automotriz. La calidad es la esencia que nos inspira en la fabricación de productos de alto rendimiento para las más acreditadas marcas a nivel mundial.

Millard® ofrece a todos los mercados, productos y servicios con el mismo y más alto nivel de calidad. Innovar y desarrollar nuevas tecnologías que permitan el funcionamiento óptimo de los fluidos en beneficio de un consumo de energía consciente y respetuoso con el medio ambiente y la salud de las poblaciones.



---

## ISO 9001-2008

---



### ISO 9001-2008

Millard® está certificada por la prestigiosa acreditadora alemana TÜV Rheinland Ibérica Inspection, Certification & Testing, según la norma UNE-EN ISO 9001-2008.

Millard® posee un avanzado sistema de aseguramiento de calidad integrado "Global Quality" que a lo largo de su cadena de producción permite alcanzar los mismos estándares de calidad definidos por la industria automotriz en todos los productos que ofrece y certifica como recambios de calidad equivalente al original.



# ÍNDICE

●	<b>INFORMACIÓN TÉCNICA</b>	<b>6</b>
●	<b>APLICACIONES</b>	<b>8</b>
●	<b>LISTA DE PRODUCTOS</b>	<b>56</b>
	 Filtros de Cabina	56
	 Filtros de Aire	60
	 Filtros de Combustible	92
	 Filtros de Aceite	106
●	<b>CROSS REFERENCES</b>	<b>118</b>
●	<b>MILLARD ONLINE</b> - <a href="http://www.millardcatalog.com">www.millardcatalog.com</a>	<b>156</b>

# INFORMACIÓN TÉCNICA

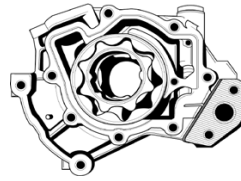

## CALIDAD EN LA INDUSTRIALIZACIÓN

Millard® supervisa los procesos productivos de sus fábricas con instrumentos de prevención de fallos AMFE (Análisis modal de fallos y efectos) aplicado al proceso de fabricación.

## CALIDAD EN LA FABRICACIÓN

Millard® supervisa los procesos. Todos los filtros estancos pasan por una fase de prueba de estanqueidad que afecta el 100% de las piezas, lo que elimina cualquier probabilidad de un producto con defecto pueda ser distribuido.

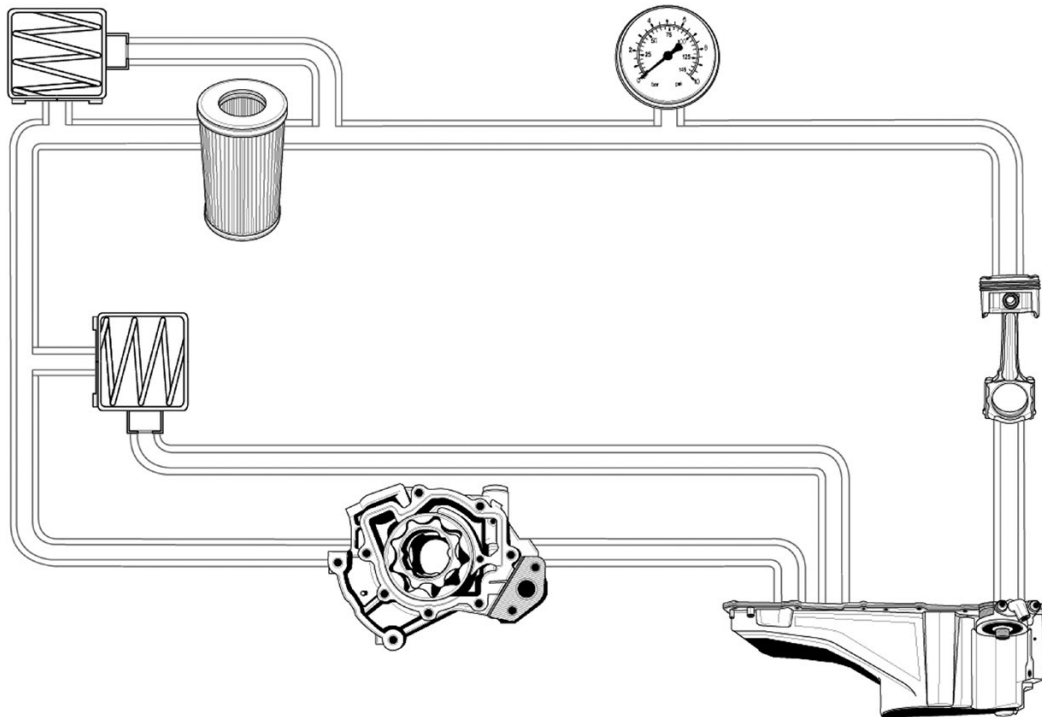



## NUESTRA LÍNEA DE PRODUCTOS

### CALIDAD EN EL DISEÑO

El diseño de productos Millard® cumple con las especificaciones requeridas por los fabricantes de Automóviles. Los diseños son auditados periódicamente a través de actividades de 'Design Review' para asegurar la puesta al día de materiales y especificaciones.

### CALIDAD EN EL DESARROLLO

El desarrollo de producto Millard® sigue las directrices marcadas por las norma TS16949 de la industria de la automoción e incluye la aplicación de las herramientas contenidas en el APQP (Planificación avanzada de la calidad de producto) de igual manera manera como que se utiliza en el desarrollo de equipos OEM.

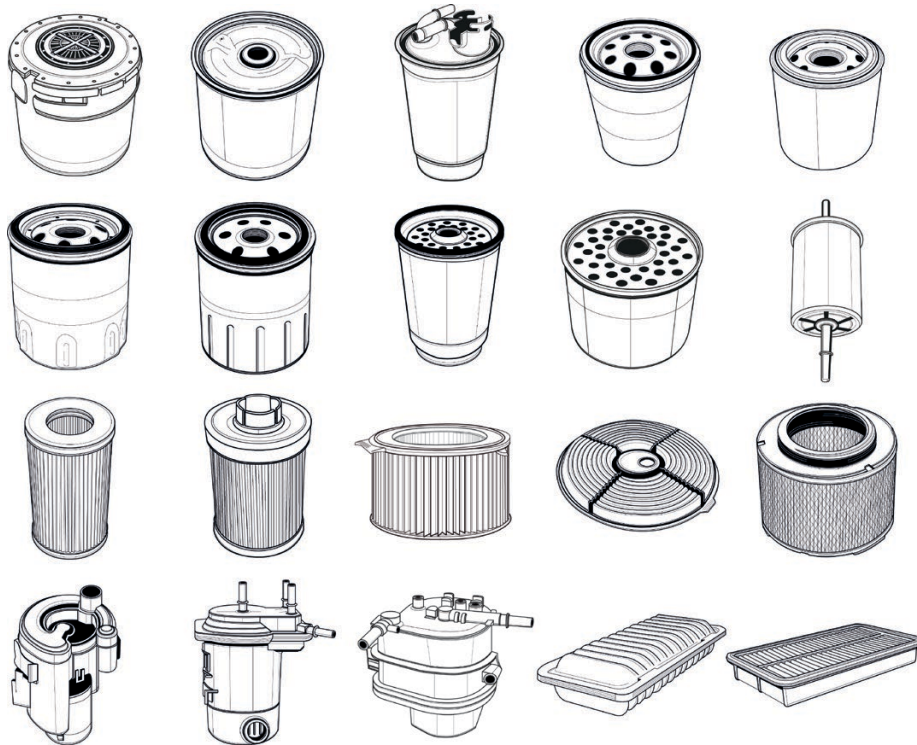



# APLICACIONES

---





BRAND	MODEL	MOTOR	FROM	TO	HP	ACEITE	AIRE	COMBUSTIBLE	CABINA
AUDI	A3	L4 1.4L	2009	2016		ML-52149	MK-35495		
AUDI	A3	L4 2.0L	2004	2010		ML-14120			
AUDI	A3	L4 2.0L	2010	2013			MK-69754		
AUDI	A3	L4 2.0L DIESEL	2010	2013		ML-9463	MK-69754		
AUDI	A3	V6 3.2L	2004	2010		ML-9463		MF-52021	
AUDI	A4	L4 1.8L	2002	2006			MK-25045		
AUDI	A4	L4 2.0L	2005	2008			MK-25045		
AUDI	A4	L4 2.0L	2006	2008		ML-14120			
AUDI	A4	L4 2.0L	2010	2017		ML-64846			
AUDI	A4	L4 2.0L (BWT)	2009	2009		ML-14120	MK-25045		
AUDI	A4	V6 3.0L	2002	2006		ML-16	MK-25045		
AUDI	A4	V6 3.2L	2005	2009			MK-25045		
AUDI	A5	L4 1.8L	2015	2015		ML-64846			
AUDI	A5	L4 2.0L	2010	2016		ML-64846			
AUDI	A5	V6 3.0L	2015	2015			MK-69754		
AUDI	A6	L4 2.0L	2012	2015		ML-64846			
AUDI	A8	V8 3.7L	2000	2003		ML-3614			
AUDI	A8	V8 4.2L	2000	2003		ML-3614			
AUDI	ALLROAD	L4 2.0L	2013	2016		ML-64846			
AUDI	Q3	L4 2.0L	2015	2016		ML-64846	MK-69754		
AUDI	Q5	L4 2.0L	2011	2016		ML-64846			
AUDI	Q5 HYBRID	L4 2.0L	2013	2016		ML-64846			
AUDI	Q7	V6 3.6L	2007	2011		ML-3614			
AUDI	QUATTRO	L4 1.8L (AMB)	2003	2006		ML-88227	MK-25045		
AUDI	QUATTRO	L4 2.0L	2005	2008		ML-14120	MK-25045		
AUDI	QUATTRO	L4 2.0L	2010	2012		ML-64846			
AUDI	QUATTRO	L4 2.0L (BWT)	2009	2009		ML-14120	MK-25045		
AUDI	QUATTRO	V6 3.0L	2003	2006		ML-16	MK-25045		
AUDI	QUATTRO	V6 3.2L	2004	2004		ML-9463	MK-5827	MF-5870	MC-5663
AUDI	QUATTRO	V6 3.2L	2007	2009			MK-25045		
AUDI	QUATTRO	V6 3.2L (BHE)	2005	2006		ML-9463	MK-5827	MF-5870	MC-5663
AUDI	QUATTRO	V6 3.2L (BKH)	2005	2006			MK-25045		
AUDI	QUATTRO	V8 4.2L	2001	2003		ML-3614			
AUDI	S8	V8 4.2L	2001	2004		ML-3614			
AUDI	TT	5 CIL. 2.5L	2014	2014		ML-14120		MF-52021	
AUDI	TT	L4 2.0L	2007	2010		ML-14120			
AUDI	TT	L4 2.0L	2009	2013		ML-64846	MK-69754		
AUDI	TT	L4 2.0L CDMA	2014	2015		ML-14120	MK-69754		
AUDI	TT	L4 2.0L CETA	2014	2015		ML-64846	MK-69754		
AUDI	TT	L5 2.5L	2012	2013		ML-14120		MF-52021	
AUDI	TT	V6 3.2L	2007	2010		ML-9463			
AUDI	TT-RS	5 CIL. 2.5L	2012	2012		ML-14120		MF-52021	
AUDI	TTS	L4 2.0L	2009	2012		ML-14120			
AUDI	TTS	L4 2.0L	2010	2011			MK-69754		

BRAND	MODEL	MOTOR	FROM	TO	HP	ACEITE	AIRE	COMBUSTIBLE	CABINA
AUDI	TTS	L4 2.0L	2012	2012				MF-52021	
AUDI	A3	L4 1.8L	1997	1997			MK-7431		
AUDI	A3	L4 1.8L	1997	2002				MF-5870	
AUDI	A3	L4 1.8L	1997	2004		ML-5552			MC-5663
AUDI	A3	L4 1.8L	1998	2004			MK-5827		
AUDI	A3	L4 1.8L	2003	2004				MF-5030	
AUDI	A3	L4 2.0L	2009	2013		ML-64846			
AUDI	A3	V6 3.2L	2004	2005				MF-1051	
AUDI	A3	V6 3.2L	2006	2009				MF-74120	
AUDI	A4	L4 1.8L	1997	1998				MF-3747	
AUDI	A4	L4 1.8L	1997	2001			MK-5107		
AUDI	A4	L4 1.8L	1997	2005		ML-5552			
AUDI	A4	L4 1.8L	1998	2005		ML-5552			
AUDI	A4	L4 1.8L	1999	2001				MF-5030	
AUDI	A4	L4 1.8L	2005	2005			MK-3660		
AUDI	A4	L4 1.8L	2005	2006		ML-88227			
AUDI	A4	L4 2.0L	2005	2005		ML-16		MF-5870	
AUDI	A4	L4 2.0L (CAEB)	2009	2009		ML-64846			
AUDI	A4	V6 2.8L	1997	2001		ML-88227			
AUDI	A4	V6 3.0L	2002	2005				MF-5870	
AUDI	A6	V6 2.7L	2000	2000				MF-3747	
AUDI	A6	V6 2.7L	2000	2004		ML-16	MK-5107		
AUDI	A6	V6 2.7L	2001	2004				MF-3747	
AUDI	A6	V6 2.8L	1998	2001			MK-5107		
AUDI	A6	V6 2.8L	1999	2001				MF-5030	
AUDI	A6	V6 2.8L	2001	2001				MF-3747	
AUDI	A6	V6 3.0L	2002	2005		ML-16	MK-5107	MF-5030	
AUDI	A6	V8 4.2L	2000	2004				MF-3747	
AUDI	A6	V8 4.2L	2000	2005			MK-5107		
AUDI	A6	V8 4.2L	2005	2005				MF-3747	
AUDI	A8	V8 3.7L	1997	2003				MF-3747	
AUDI	A8	V8 4.2L	2004	2006				MF-5870	
AUDI	A8	W12 6.0L	2005	2010				MF-5870	
AUDI	ALLROAD	V6 2.7L	2001	2005		ML-16	MK-5107	MF-3747	
AUDI	ALLROAD	V8 4.2L	2003	2003				MF-5030	
AUDI	ALLROAD	V8 4.2L	2003	2005			MK-5107	MF-3747	
AUDI	ALLROAD	V8 4.2L	2005	2005		ML-16			
AUDI	CABRIOLET	V6 2.8L	1997	1998		ML-88227			
AUDI	QUATTRO	L4 1.8L	1997	1998				MF-3747	
AUDI	QUATTRO	L4 1.8L	1997	2002			MK-5107		
AUDI	QUATTRO	L4 1.8L	1997	2006		ML-5552			
AUDI	QUATTRO	L4 1.8L	1998	1998		ML-88227			
AUDI	QUATTRO	L4 1.8L	2000	2002				MF-5030	
AUDI	QUATTRO	L4 1.8L	2000	2006					MC-5663

BRAND	MODEL	MOTOR	FROM	TO	HP	ACEITE	AIRE	COMBUSTIBLE	CABINA
AUDI	QUATTRO	L4 1.8L	2004	2006			MK-5827	MF-5870	
AUDI	QUATTRO	L4 1.8L (AWP)	2003	2003		ML-5552	MK-5827	MF-5870	MC-5663
AUDI	QUATTRO	L4 2.0L (CAEB)	2009	2009		ML-64846			
AUDI	QUATTRO	V6 2.7L	2002	2005		ML-16	MK-5107	MF-3747	
AUDI	QUATTRO	V6 2.8L	1997	1998				MF-3747	
AUDI	QUATTRO	V6 2.8L	1997	2001		ML-88227	MK-5107		
AUDI	QUATTRO	V6 2.8L	1999	2001				MF-5030	
AUDI	QUATTRO	V6 2.8L	2000	2000				MF-3747	
AUDI	QUATTRO	V6 3.0L	2002	2002		ML-3614			
AUDI	QUATTRO	V6 3.0L	2002	2004			MK-5107	MF-3747	
AUDI	QUATTRO	V6 3.0L	2002	2005				MF-5870	
AUDI	QUATTRO	V6 3.0L	2003	2004				MF-5030	
AUDI	QUATTRO	V8 3.7L	1997	1999				MF-3747	
AUDI	QUATTRO	V8 4.2L	1997	2005				MF-3747	
AUDI	QUATTRO	V8 4.2L	2005	2005			MK-5107		
AUDI	QUATTRO	V8 4.2L (AWN)	2003	2004			MK-5107	MF-3747	
AUDI	QUATTRO	V8 4.2L (BAS)	2004	2004			MK-5107	MF-3747	
AUDI	QUATTRO	V8 4.2L (BFM)	2004	2006				MF-5870	
AUDI	QUATTRO	W12 6.0L	2005	2010				MF-5870	
AUDI	RS6	V8 4.2L	2003	2004		ML-5552		MF-6400	
AUDI	S3	L4 1.8L	2001	2003					MC-5663
AUDI	S4	V6 2.7L	2000	2000		ML-16		MF-3747	
AUDI	S4	V6 2.7L	2000	2002			MK-5107		
AUDI	S4	V6 2.7L	2001	2002		ML-3614		MF-3747	
AUDI	S4	V8 4.2L	2009	2009				MF-5870	
AUDI	S6	V6 2.7L	2002	2002		ML-3614	MK-5107	MF-3747	
AUDI	S6	V8 4.2L	2000	2004				MF-3747	
AUDI	S6	V8 4.2L	2002	2004			MK-5107		
AUDI	S8	V8 4.2L	2001	2003				MF-3747	
AUDI	S8	V8 4.2L	2004	2004				MF-3747	
AUDI	TT	L4 1.8L	2000	2004		ML-5552			
AUDI	TT	L4 1.8L	2000	2006		ML-5552	MK-5827	MF-5870	MC-5663
AUDI	TT	V6 3.2L	2004	2005				MF-5870	MC-5663
AUDI	TT	V6 3.2L	2007	2007			MK-5827		
AUDI	TT	V6 3.2L	2007	2008				MF-74120	
AUDI	TT	V6 3.2L	2008	2010				MF-52021	
CHEVROLET	ASTRA	L4 1.8L	2007	2008		ML-19626			
CHEVROLET	AVALANCHE	V8 5.3L	2007	2013		ML-10060			
CHEVROLET	AVALANCHE	V8 6.0L	2007	2009		ML-10060	MK-5070		
CHEVROLET	AVEO (USA)	L4 1.6L	2009	2011		ML-19626			
CHEVROLET	CAMARO	V6 3.6L	2016	2017		ML-10060			
CHEVROLET	CAMARO	V8 6.2L	2010	2015		ML-10060			
CHEVROLET	CAMARO	V8 7.0L	2015	2015		ML-10060			
CHEVROLET	CAPRICE	V8 6.0L	2011	2016		ML-10060			

BRAND	MODEL	MOTOR	FROM	TO	HP	ACEITE	AIRE	COMBUSTIBLE	CABINA
CHEVROLET	CAPTIVA	V6 3.0L	2012	2012		ML-10060			
CHEVROLET	CAPTIVA	V6 3.0L	2013	2015		ML-10060			
CHEVROLET	CAPTIVA	V6 3.6L	2008	2011		ML-10060	MK-55267		
CHEVROLET	CHEYENNE	V8 5.3L	2007	2015		ML-10060			
CHEVROLET	CHEYENNE	V8 6.2L	2015	2015		ML-10060	MK-5070		
CHEVROLET	CITY EXPRESS	L4 2.0L	2015	2015		ML-6607	MK-35681		
CHEVROLET	COLORADO	L4 2.5L	2015	2015		ML-10060			
CHEVROLET	COLORADO	V8 5.3L	2007	2012		ML-10060			
CHEVROLET	CORVETTE	V8 6.0L	2007	2007		ML-10060			
CHEVROLET	CORVETTE	V8 6.2L	2008	2015		ML-10060			
CHEVROLET	CORVETTE	V8 7.0L	2006	2013		ML-10060			
CHEVROLET	CRUZE	L4 1.4L	2010	2016		ML-19626	MK-14641		
CHEVROLET	CRUZE	L4 1.8L	2010	2016		ML-19626			
CHEVROLET	CRUZE	L4 1.8L	2011	2016			MK-25175		
CHEVROLET	CRUZE	L4 2.0L DIESEL	2014	2015			MK-14641		
CHEVROLET	EQUINOX	V6 3.0L	2010	2010		ML-10060			
CHEVROLET	EQUINOX	V6 3.0L	2011	2012		ML-10060			
CHEVROLET	EQUINOX	V6 3.6L	2008	2009		ML-10060			
CHEVROLET	EQUINOX	V6 3.6L	2013	2017		ML-10060			
CHEVROLET	EXPRESS 1500	V8 4.8L	2015	2015		ML-10060	MK-40048		
CHEVROLET	EXPRESS 1500	V8 5.3L	2014	2014		ML-10060	MK-40048		
CHEVROLET	EXPRESS 1500	V8 6.0L	2015	2015		ML-10060	MK-40048		
CHEVROLET	EXPRESS 2500	V8 4.8L	2014	2016		ML-10060	MK-40048		
CHEVROLET	EXPRESS 2500	V8 6.0L	2014	2016		ML-10060	MK-40048		
CHEVROLET	EXPRESS 3500	V8 4.8L	2014	2016		ML-10060	MK-40048		
CHEVROLET	EXPRESS 3500	V8 6.0L	2014	2016		ML-10060	MK-40048		
CHEVROLET	EXPRESS 4500	V8 6.0L	2014	2017		ML-10060	MK-40048		
CHEVROLET	EXPRESS VAN	V8 4.8L	2007	2013		ML-10060			
CHEVROLET	EXPRESS VAN	V8 5.3L	2007	2013		ML-10060			
CHEVROLET	EXPRESS VAN	V8 6.0L	2007	2013		ML-10060			
CHEVROLET	G SERIES	V8 4.8L	2007	2012		ML-10060			
CHEVROLET	G SERIES	V8 5.3L	2007	2012		ML-10060			
CHEVROLET	G SERIES	V8 6.0L	2007	2012		ML-10060			
CHEVROLET	IMPALA	L4 2.5L	2014	2015		ML-10060			
CHEVROLET	IMPALA	V6 3.6L	2012	2014		ML-10060			
CHEVROLET	IMPALA	V6 3.6L	2013	2016		ML-10060			
CHEVROLET	IMPALA	V6 3.6L BI-FUEL	2015	2015		ML-10060			
CHEVROLET	IMPALA	V6 3.6L FLEX FUEL	2015	2015		ML-10060			
CHEVROLET	IMPALA	V8 5.3L	2007	2010		ML-10060			
CHEVROLET	MALIBU	L4 2.0L	2013	2015		ML-10060			
CHEVROLET	MALIBU	L4 2.5L	2013	2015		ML-10060			
CHEVROLET	MALIBU	V6 3.6L	2008	2012		ML-10060			
CHEVROLET	METRO	3 CIL 1.0L	1998	2001		ML-3614	MK-21050		
CHEVROLET	METRO	L4 1.3L	1998	2001		ML-3614			

BRAND	MODEL	MOTOR	FROM	TO	HP	ACEITE	AIRE	COMBUSTIBLE	CABINA
CHEVROLET	MONTECARLO	V8 5.3L	2007	2007		ML-10060			
CHEVROLET	ORLANDO	L4 2.4L	2012	2014		ML-9018	MK-14641		
CHEVROLET	SILVERADO	V8 4.8L	2007	2013		ML-10060			
CHEVROLET	SILVERADO	V8 5.3L	2007	2013		ML-10060			
CHEVROLET	SILVERADO	V8 6.0L	2007	2013		ML-10060			
CHEVROLET	SILVERADO	V8 6.2L	2007	2013		ML-10060	MK-5070		
CHEVROLET	SILVERADO 1500	V6 4.3L	2014	2016		ML-10060	MK-5070		
CHEVROLET	SILVERADO 1500	V8 5.3L	2014	2016		ML-10060	MK-5070		
CHEVROLET	SILVERADO 1500	V8 6.2L	2014	2016		ML-10060	MK-5070		
CHEVROLET	SILVERADO 2500	V8 6.0L	2014	2016		ML-10060	MK-5070		
CHEVROLET	SILVERADO 2500	V8 6.0L CNG	2015	2015		ML-10060	MK-5070		
CHEVROLET	SILVERADO 3500	V8 6.0L	2014	2016		ML-10060	MK-5070		
CHEVROLET	SILVERADO HYBRID	V8 5.3L	2008	2008		ML-10060	MK-5070		
CHEVROLET	SILVERADO HYBRID	V8 6.0L	2009	2013		ML-10060	MK-5070		
CHEVROLET	SONIC	L4 1.4L	2012	2016		ML-19626			
CHEVROLET	SONIC	L4 1.6L	2012	2015		ML-19626			
CHEVROLET	SONIC	L4 1.8L	2012	2016		ML-19626			
CHEVROLET	SS	V8 6.2L	2014	2016		ML-10060			
CHEVROLET	SUBURBAN	V8 4.8L	2007	2008		ML-10060			
CHEVROLET	SUBURBAN	V8 5.3L	2007	2014		ML-10060			
CHEVROLET	SUBURBAN	V8 5.3L	2015	2016		ML-10060			
CHEVROLET	SUBURBAN	V8 6.0L	2007	2013		ML-10060			
CHEVROLET	SUBURBAN	V8 6.2L	2007	2008		ML-10060	MK-5070		
CHEVROLET	TAHOE	V8 4.8L	2007	2010		ML-10060			
CHEVROLET	TAHOE	V8 5.3L	2007	2014		ML-10060			
CHEVROLET	TAHOE	V8 5.3L	2015	2016		ML-10060			
CHEVROLET	TAHOE	V8 6.0L	2007	2009		ML-10060			
CHEVROLET	TAHOE	V8 6.2L	2007	2010		ML-10060	MK-5070		
CHEVROLET	TAHOE HYBRID	V8 6.0L	2008	2013		ML-10060	MK-5070		
CHEVROLET	TRAIL BLAZER	V8 5.3L	2007	2009		ML-10060			
CHEVROLET	TRAIL BLAZER	V8 6.0L	2007	2009		ML-10060			
CHEVROLET	TRAVERSE	V6 3.6L	2009	2010		ML-10060			
CHEVROLET	TRAVERSE	V6 3.6L	2011	2017		ML-10060			
CHEVROLET	TRAX	L4 1.4L	2013	2017		ML-19626			
CHEVROLET	TRAX	L4 1.8L	2013	2015		ML-19626			
CHEVROLET	400 SS	V8 5.7L	1999	2001		ML-13	MK-5070		
CHEVROLET	ASTRA	L4 1.8L	2000	2003				MF-618	
CHEVROLET	ASTRA	L4 1.8L	2000	2008			MK-5970		
CHEVROLET	ASTRA	L4 1.8L	2002	2008		ML-3387			
CHEVROLET	ASTRA	L4 2.0L	2004	2006			MK-9684	MF-618	
CHEVROLET	ASTRA	L4 2.0L	2004	2008		ML-3387			
CHEVROLET	ASTRA	L4 2.2L	2000	2004				MF-618	
CHEVROLET	ASTRA	L4 2.2L	2000	2006		ML-9018	MK-9684		
CHEVROLET	ASTRA	L4 2.2L	2005	2006				MF-986	

BRAND	MODEL	MOTOR	FROM	TO	HP	ACEITE	AIRE	COMBUSTIBLE	CABINA
CHEVROLET	ASTRA	L4 2.4L	2004	2006			MK-9684	MF-618	
CHEVROLET	ASTRO	V6 4.3L	2001	2005		ML-3387			
CHEVROLET	AVALANCHE	V8 5.3L	2002	2005				MF-481	
CHEVROLET	AVALANCHE	V8 5.3L	2002	2006		ML-4952			
CHEVROLET	AVALANCHE	V8 5.3L	2002	2013			MK-5070		
CHEVROLET	AVALANCHE	V8 5.3L	2006	2006				MF-645A	
CHEVROLET	AVALANCHE	V8 8.1L	2002	2005				MF-481	
CHEVROLET	AVALANCHE	V8 8.1L	2002	2006			MK-5070		
CHEVROLET	AVEO (MEXICO)	L4 1.6L	2008	2015		ML-3387	MK-9902	MF-619	
CHEVROLET	AVEO (USA)	L4 1.6L	2004	2008		ML-3387			
CHEVROLET	AVEO (USA)	L4 1.6L	2004	2011			MK-9902		
CHEVROLET	BLAZER	L4 2.2L	2000	2000				MF-645A	
CHEVROLET	BLAZER	L4 2.2L	2000	2001		ML-3387	MK-7421		
CHEVROLET	BLAZER	L6 4.2L	2002	2002		ML-3675	MK-9345	MF-6397	
CHEVROLET	BLAZER	V6 4.3L	1999	2005				MF-645A	
CHEVROLET	C SERIES	V8 5.7L	2002	2002			MK-5070		
CHEVROLET	C SERIES	V8 6.5L DIESEL	1997	2001			MK-8038		
CHEVROLET	C SERIES	V8 8.1L	2001	2001			MK-8038	MF-481	
CHEVROLET	CAMARO	V8 5.7L	1998	2002		ML-4952			
CHEVROLET	CAPTIVA	L4 2.4L	2008	2015		ML-9018	MK-55267		
CHEVROLET	CAPTIVA	V6 3.0L	2012	2013			MK-55267		
CHEVROLET	CAVALIER	L4 2.2L	2002	2005		ML-9018			
CHEVROLET	CHEVY C2	L4 1.6L	2004	2008		ML-3387	MK-5496	MF-618	
CHEVROLET	CHEYENNE	V8 5.3L	2003	2005		ML-4952			
CHEVROLET	CHEYENNE	V8 5.3L	2003	2015			MK-5070		
CHEVROLET	CHEYENNE	V8 5.3L	2006	2007		ML-3675			
CHEVROLET	CHEYENNE	V8 5.3L	2006	2015				MF-481	
CHEVROLET	CHEYENNE	V8 5.7L	1999	2001		ML-13			
CHEVROLET	CHEYENNE	V8 5.7L	1999	2002			MK-5070		
CHEVROLET	CHEYENNE	V8 5.7L	2002	2002		ML-4952			
CHEVROLET	CITY EXPRESS	L4 2.0L	2016	2016		ML-4847			
CHEVROLET	COBALT	L4 2.0L	2005	2005			MK-9345		
CHEVROLET	COBALT	L4 2.0L	2005	2010		ML-9018			
CHEVROLET	COBALT	L4 2.2L	2005	2010		ML-9018			
CHEVROLET	COBALT	L4 2.4L	2005	2009		ML-9018			
CHEVROLET	COLORADO	5 CIL 3.5L	2004	2004		ML-4952			
CHEVROLET	COLORADO	5 CIL 3.5L	2004	2005				MF-580	
CHEVROLET	COLORADO	5 CIL 3.5L	2005	2006		ML-3675			
CHEVROLET	COLORADO	5 CIL 3.7L	2007	2012		ML-3675			
CHEVROLET	COLORADO	5 CIL 3.7L	2008	2012			MK-76855		
CHEVROLET	COLORADO	L4 2.8L	2004	2005				MF-580	
CHEVROLET	COLORADO	L4 2.8L	2004	2006		ML-4952			
CHEVROLET	COLORADO	L4 2.9L	2007	2012		ML-4952			
CHEVROLET	COLORADO	L4 2.9L	2008	2012			MK-76855		

BRAND	MODEL	MOTOR	FROM	TO	HP	ACEITE	AIRE	COMBUSTIBLE	CABINA
CHEVROLET	COLORADO	V8 5.3L	2009	2012			MK-76855		
CHEVROLET	CORSA	L4 1.8L	2002	2008		ML-3387	MK-9391	MF-618	
CHEVROLET	CORVETTE	V8 5.7L	1997	2004		ML-4952			
CHEVROLET	CORVETTE	V8 6.0L	2005	2006		ML-4952			
CHEVROLET	CORVETTE	V8 6.0L	2005	2007			MK-5070		
CHEVROLET	CUTLASS	V6 3.1L	1997	1997			MK-5070	MF-578	
CHEVROLET	EPICA	6 CIL. 2.5L	2009	2009		ML-3675			
CHEVROLET	EQUINOX	L4 2.4L	2010	2017		ML-9018			
CHEVROLET	EQUINOX	V6 3.4L	2005	2009		ML-3387			
CHEVROLET	EXPRESS 1500	V6 4.3L	2014	2014		ML-3387	MK-40048		
CHEVROLET	EXPRESS VAN	V6 4.3L	1997	1999		ML-5934			
CHEVROLET	EXPRESS VAN	V6 4.3L	1997	2002				MF-580	
CHEVROLET	EXPRESS VAN	V6 4.3L	2000	2013		ML-3387			
CHEVROLET	EXPRESS VAN	V6 4.3L	2001	2013			MK-40048		
CHEVROLET	EXPRESS VAN	V6 4.3L	2003	2005				MF-481	
CHEVROLET	EXPRESS VAN	V6 4.3L	2005	2005				MF-578	
CHEVROLET	EXPRESS VAN	V8 4.8L	2003	2005				MF-578	
CHEVROLET	EXPRESS VAN	V8 4.8L	2003	2006		ML-4952			
CHEVROLET	EXPRESS VAN	V8 4.8L	2003	2013			MK-40048		
CHEVROLET	EXPRESS VAN	V8 4.8L	2005	2005				MF-481	
CHEVROLET	EXPRESS VAN	V8 5.0L	1997	2002		ML-13		MF-580	
CHEVROLET	EXPRESS VAN	V8 5.0L	2001	2002			MK-40048		
CHEVROLET	EXPRESS VAN	V8 5.3L	2003	2005				MF-578	
CHEVROLET	EXPRESS VAN	V8 5.3L	2003	2006		ML-4952			
CHEVROLET	EXPRESS VAN	V8 5.3L	2003	2013			MK-40048		
CHEVROLET	EXPRESS VAN	V8 5.3L	2005	2005				MF-481	
CHEVROLET	EXPRESS VAN	V8 5.7L	1997	2003		ML-13		MF-580	
CHEVROLET	EXPRESS VAN	V8 5.7L	2001	2003			MK-40048		
CHEVROLET	EXPRESS VAN	V8 6.0L	2003	2005				MF-481	
CHEVROLET	EXPRESS VAN	V8 6.0L	2003	2006		ML-4952			
CHEVROLET	EXPRESS VAN	V8 6.0L	2003	2013			MK-40048		
CHEVROLET	EXPRESS VAN	V8 6.0L GAS NATURAL	2003	2005		ML-4952	MK-40048		
CHEVROLET	EXPRESS VAN	V8 6.5L DIESEL	1997	2002		ML-13			
CHEVROLET	EXPRESS VAN	V8 7.4L	1997	1998		ML-13			
CHEVROLET	EXPRESS VAN	V8 7.4L	1997	2000				MF-580	
CHEVROLET	EXPRESS VAN	V8 8.1L	2001	2002			MK-40048	MF-580	
CHEVROLET	G SERIES	V6 4.3L	1997	1998		ML-13			
CHEVROLET	G SERIES	V6 4.3L	1997	2002				MF-580	
CHEVROLET	G SERIES	V6 4.3L	2000	2012		ML-3387			
CHEVROLET	G SERIES	V6 4.3L	2001	2012			MK-40048		
CHEVROLET	G SERIES	V8 4.8L	2003	2003				MF-578	
CHEVROLET	G SERIES	V8 4.8L	2003	2006		ML-4952			
CHEVROLET	G SERIES	V8 4.8L	2003	2012			MK-40048		
CHEVROLET	G SERIES	V8 5.0L	2001	2002			MK-40048		

BRAND	MODEL	MOTOR	FROM	TO	HP	ACEITE	AIRE	COMBUSTIBLE	CABINA
CHEVROLET	G SERIES	V8 5.3L	2003	2004				MF-578	
CHEVROLET	G SERIES	V8 5.3L	2003	2006		ML-4952			
CHEVROLET	G SERIES	V8 5.3L	2003	2012			MK-40048		
CHEVROLET	G SERIES	V8 5.3L	2004	2004				MF-481	
CHEVROLET	G SERIES	V8 5.7L	1997	2003				MF-580	
CHEVROLET	G SERIES	V8 5.7L	2001	2003			MK-40048		
CHEVROLET	G SERIES	V8 6.0L	2003	2004				MF-481	
CHEVROLET	G SERIES	V8 6.0L	2003	2006		ML-4952			
CHEVROLET	G SERIES	V8 6.0L	2003	2012			MK-40048		
CHEVROLET	G SERIES	V8 7.4L	1997	1999				MF-580	
CHEVROLET	G SERIES	V8 8.1L	2001	2002			MK-40048	MF-580	
CHEVROLET	HHR	L4 2.0L	2008	2010		ML-9018			
CHEVROLET	HHR	L4 2.2L	2006	2011		ML-9018			
CHEVROLET	HHR	L4 2.4L	2006	2011		ML-9018			
CHEVROLET	IMPALA	V6 3.1L	2000	2001		ML-3387	MK-5070	MF-578	
CHEVROLET	IMPALA	V6 3.4L	2000	2005		ML-3387		MF-578	
CHEVROLET	IMPALA	V6 3.5L	2006	2011		ML-3675			
CHEVROLET	IMPALA	V6 3.8L	2000	2005		ML-3387		MF-578	
CHEVROLET	IMPALA	V6 3.9L	2006	2011		ML-3675			
CHEVROLET	IMPALA	V8 5.3L	2006	2006		ML-3675			
CHEVROLET	IMPALA HYBRID	L4 2.4L	2014	2014		ML-9018			
CHEVROLET	K SERIES	V8 6.5L DIESEL	1997	2000			MK-8038		
CHEVROLET	K SERIES	V8 6.5L DIESEL	1999	1999			MK-8038		
CHEVROLET	KODIAK	CATERPILLAR 3126 7.2L	2006	2007		ML-49		MF-29341	
CHEVROLET	KODIAK	V8 8.1L	2002	2002			MK-8038		
CHEVROLET	KODIAK	V8 8.1L	2002	2005				MF-481	
CHEVROLET	KODIAK C4500	V8 8.1L	2005	2005				MF-578	
CHEVROLET	KODIAK C5500	V8 8.1L	2005	2005				MF-578	
CHEVROLET	LUMINA	V6 3.4L	2000	2003		ML-3387			
CHEVROLET	LUMINA	V6 3.8L	1998	1999			MK-5070		
CHEVROLET	LUMINA	V6 3.8L	1998	2003		ML-3387		MF-578	
CHEVROLET	LUV	L4 2.2L	2002	2006		ML-3593	MK-8067	MF-618	
CHEVROLET	LUV	L4 2.3L	1997	1998			MK-4939	MF-481	
CHEVROLET	LUV	L4 2.3L	1997	2001		ML-3593			
CHEVROLET	LUV	L4 2.3L	1999	2001			MK-8067	MF-618	
CHEVROLET	MALIBU	L4 2.0L	2014	2014			MK-5070		
CHEVROLET	MALIBU	L4 2.2L	2004	2005			MK-7597	MF-578	
CHEVROLET	MALIBU	L4 2.2L	2004	2008		ML-9018	MK-5070		
CHEVROLET	MALIBU	L4 2.4L	1997	1999		ML-4952	MK-7597	MF-578	
CHEVROLET	MALIBU	L4 2.4L	2008	2012		ML-9018			
CHEVROLET	MALIBU	L4 2.5L	2014	2014			MK-5070		
CHEVROLET	MALIBU	V6 3.1L	1997	2003			MK-7597		
CHEVROLET	MALIBU	V6 3.1L	1997	2004				MF-578	
CHEVROLET	MALIBU	V6 3.1L	1997	2005		ML-3387			



BRAND	MODEL	MOTOR	FROM	TO	HP	ACEITE	AIRE	COMBUSTIBLE	CABINA
CHEVROLET	MALIBU	V6 3.1L	2004	2005			MK-5070		
CHEVROLET	MALIBU	V6 3.4L	2003	2003		ML-3387		MF-578	
CHEVROLET	MALIBU	V6 3.5L	2004	2006		ML-3387	MK-5070		
CHEVROLET	MALIBU	V6 3.5L	2007	2010		ML-3675			
CHEVROLET	MALIBU	V6 3.9L	2006	2006			MK-5070		
CHEVROLET	MALIBU	V6 3.9L	2006	2008		ML-3675			
CHEVROLET	MALIBU HYBRID	L4 2.4L	2008	2014		ML-9018			
CHEVROLET	MATIZ	L4 1.0L	2011	2015		ML-4967	MK-91485	MF-619	
CHEVROLET	MERIVA	L4 1.8L	2004	2008		ML-3387	MK-9391	MF-618	
CHEVROLET	MONTECARLO	V6 3.4L	2000	2005		ML-3387			
CHEVROLET	MONTECARLO	V6 3.5L	2007	2007		ML-3675			
CHEVROLET	MONTECARLO	V6 3.8L	1998	1999			MK-5070		
CHEVROLET	MONTECARLO	V6 3.8L	1998	2005				MF-578	
CHEVROLET	MONTECARLO	V6 3.9L	2007	2007		ML-3675			
CHEVROLET	OPTRA	L4 2.0L	2004	2010		ML-3387	MK-8732		
CHEVROLET	OPTRA	L4 2.0L	2006	2009				MF-619	
CHEVROLET	P SERIES	V8 7.4L	1998	1999			MK-8038		
CHEVROLET	PRIZM	L4 1.6L	1998	1998		ML-4967		MF-9145	
CHEVROLET	PRIZM	L4 1.8L	1998	2002		ML-4967	MK-5466		
CHEVROLET	S10	L4 2.2L	2003	2003		ML-5934			
CHEVROLET	S10	L4 2.2L	2004	2004		ML-9018			
CHEVROLET	S10	L4 2.2L	2004	2005			MK-3916	MF-578	
CHEVROLET	S10	V6 3.4L	2001	2001		ML-5934	MK-7421	MF-645A	
CHEVROLET	S10	V6 3.4L	2003	2005		ML-3387	MK-7597	MF-578	
CHEVROLET	S10	V6 3.5L	2005	2006		ML-3387			
CHEVROLET	S10	V6 3.8L	2003	2005		ML-3387	MK-6479	MF-578	
CHEVROLET	S10	V6 3.9L	2006	2006		ML-3675			
CHEVROLET	S10	V6 4.3L	1997	2004				MF-645A	
CHEVROLET	S10	V6 4.3L	2001	2003		ML-3387			
CHEVROLET	S10	V8 4.6L	2004	2005		ML-3675	MK-5070	MF-578	
CHEVROLET	SILVERADO	V6 4.3L	1999	1999		ML-5934			
CHEVROLET	SILVERADO	V6 4.3L	1999	2007				MF-481	
CHEVROLET	SILVERADO	V6 4.3L	1999	2013			MK-5070		
CHEVROLET	SILVERADO	V6 4.3L	2000	2013		ML-3387			
CHEVROLET	SILVERADO	V8 4.8L	1999	2002		ML-3675			
CHEVROLET	SILVERADO	V8 4.8L	1999	2005				MF-481	
CHEVROLET	SILVERADO	V8 4.8L	1999	2013			MK-5070		
CHEVROLET	SILVERADO	V8 4.8L	2003	2006		ML-4952			
CHEVROLET	SILVERADO	V8 5.3L	1999	2002		ML-3675			
CHEVROLET	SILVERADO	V8 5.3L	1999	2006				MF-481	
CHEVROLET	SILVERADO	V8 5.3L	1999	2013			MK-5070		
CHEVROLET	SILVERADO	V8 5.3L	2002	2005				MF-645A	
CHEVROLET	SILVERADO	V8 5.3L	2003	2006		ML-4952			
CHEVROLET	SILVERADO	V8 5.7L	2000	2000		ML-5934	MK-8038		

BRAND	MODEL	MOTOR	FROM	TO	HP	ACEITE	AIRE	COMBUSTIBLE	CABINA
CHEVROLET	SILVERADO	V8 5.7L	2002	2002			MK-5070		
CHEVROLET	SILVERADO	V8 6.0L	1999	2002		ML-3675			
CHEVROLET	SILVERADO	V8 6.0L	1999	2005				MF-481	
CHEVROLET	SILVERADO	V8 6.0L	1999	2013			MK-5070		
CHEVROLET	SILVERADO	V8 6.0L	2003	2006		ML-4952			
CHEVROLET	SILVERADO	V8 6.5L DIESEL	1999	1999		ML-13	MK-8038		
CHEVROLET	SILVERADO	V8 8.1L	2001	2002			MK-8038		
CHEVROLET	SILVERADO	V8 8.1L	2001	2005				MF-481	
CHEVROLET	SILVERADO	V8 8.1L	2001	2007			MK-5070		
CHEVROLET	SONIC	L4 1.4L	2012	2015			MK-32823		
CHEVROLET	SONIC	L4 1.6L	2012	2013			MK-32823		
CHEVROLET	SONIC	L4 1.8L	2012	2015			MK-32823		
CHEVROLET	SONORA	V8 5.3L	2003	2003		ML-3675	MK-5070	MF-481	
CHEVROLET	SONORA	V8 5.7L	2000	2006		ML-13	MK-5070	MF-481	
CHEVROLET	SPARK	L4 1.2L	2011	2015		ML-92095	MK-92369		
CHEVROLET	SSR	V8 5.3L	2003	2004		ML-4952		MF-6397	
CHEVROLET	SSR	V8 6.0L	2005	2005				MF-6397	
CHEVROLET	SSR	V8 6.0L	2005	2006		ML-4952			
CHEVROLET	SUBURBAN	V6 4.3L	1997	1998			MK-8038		
CHEVROLET	SUBURBAN	V6 4.3L	2000	2008		ML-3387	MK-5070		
CHEVROLET	SUBURBAN	V8 4.8L	2000	2002		ML-3675			
CHEVROLET	SUBURBAN	V8 4.8L	2000	2004				MF-481	
CHEVROLET	SUBURBAN	V8 4.8L	2000	2008			MK-5070		
CHEVROLET	SUBURBAN	V8 4.8L	2003	2004		ML-4952			
CHEVROLET	SUBURBAN	V8 5.0L	1997	1999		ML-5934	MK-8038		
CHEVROLET	SUBURBAN	V8 5.3L	2000	2002		ML-3675			
CHEVROLET	SUBURBAN	V8 5.3L	2000	2005				MF-481	
CHEVROLET	SUBURBAN	V8 5.3L	2000	2016			MK-5070		
CHEVROLET	SUBURBAN	V8 5.3L	2002	2005				MF-645A	
CHEVROLET	SUBURBAN	V8 5.3L	2003	2006		ML-4952			
CHEVROLET	SUBURBAN	V8 5.7L	2001	2002		ML-3675	MK-5070		
CHEVROLET	SUBURBAN	V8 6.0L	2000	2002		ML-3675			
CHEVROLET	SUBURBAN	V8 6.0L	2000	2005				MF-481	
CHEVROLET	SUBURBAN	V8 6.0L	2000	2013			MK-5070		
CHEVROLET	SUBURBAN	V8 6.0L	2003	2006		ML-4952			
CHEVROLET	SUBURBAN	V8 6.5L DIESEL	1997	1998			MK-8038		
CHEVROLET	SUBURBAN	V8 8.1L	2001	2005				MF-481	
CHEVROLET	SUBURBAN	V8 8.1L	2001	2006			MK-5070		
CHEVROLET	TAHOE	V6 4.3L	1997	1998		ML-5934	MK-8038	MF-481	
CHEVROLET	TAHOE	V6 4.3L	2002	2009		ML-3387	MK-5070		
CHEVROLET	TAHOE	V8 4.8L	2000	2002		ML-3675			
CHEVROLET	TAHOE	V8 4.8L	2000	2005				MF-481	
CHEVROLET	TAHOE	V8 4.8L	2000	2010			MK-5070		
CHEVROLET	TAHOE	V8 4.8L	2003	2006		ML-4952			

BRAND	MODEL	MOTOR	FROM	TO	HP	ACEITE	AIRE	COMBUSTIBLE	CABINA
CHEVROLET	TAHOE	V8 5.0L	1997	1998		ML-13	MK-8038	MF-481	
CHEVROLET	TAHOE	V8 5.3L	2000	2002		ML-3675			
CHEVROLET	TAHOE	V8 5.3L	2000	2005				MF-481	
CHEVROLET	TAHOE	V8 5.3L	2000	2015			MK-5070		
CHEVROLET	TAHOE	V8 5.3L	2002	2005				MF-645A	
CHEVROLET	TAHOE	V8 5.3L	2003	2006		ML-4952			
CHEVROLET	TAHOE	V8 6.0L	2001	2002		ML-3675			
CHEVROLET	TAHOE	V8 6.0L	2001	2009			MK-5070		
CHEVROLET	TAHOE	V8 6.0L	2002	2002				MF-481	
CHEVROLET	TAHOE	V8 6.5L DIESEL	1997	1999			MK-8038		
CHEVROLET	TIGRA	L4 1.6L	1999	1999		ML-3387			
CHEVROLET	TORNADO	L4 1.8L	2004	2011			MK-9391	MF-618	
CHEVROLET	TORNADO	L4 1.8L	2004	2015		ML-3387			
CHEVROLET	TORNADO	L4 1.8L	2012	2012				MF-481	
CHEVROLET	TRACKER	L4 1.6L	1998	1998			MK-7617		
CHEVROLET	TRACKER	L4 1.6L	1999	2002			MK-8069		
CHEVROLET	TRACKER	L4 1.6L	2000	2002		ML-5166		MF-5982	
CHEVROLET	TRACKER	L4 2.0L	1999	2008		ML-5166	MK-8069	MF-5982	
CHEVROLET	TRACKER	V6 2.5L	2001	2004		ML-3614	MK-8069	MF-5982	
CHEVROLET	TRAIL BLAZER	6 CIL. 4.2L	2002	2005				MF-6397	
CHEVROLET	TRAIL BLAZER	6 CIL. 4.2L	2002	2009		ML-3675	MK-9345		
CHEVROLET	TRAIL BLAZER	V8 5.3L	2003	2005				MF-6397	
CHEVROLET	TRAIL BLAZER	V8 5.3L	2003	2006		ML-4952			
CHEVROLET	TRAIL BLAZER	V8 5.3L	2003	2009			MK-9345		
CHEVROLET	TRAIL BLAZER	V8 6.0L	2006	2006		ML-4952			
CHEVROLET	TRAIL BLAZER	V8 6.0L	2006	2009			MK-9345		
CHEVROLET	UPLANDER	V6 3.5L	2005	2006		ML-3387	MK-5070		
CHEVROLET	UPLANDER	V6 3.9L	2006	2010		ML-3675	MK-5070		
CHEVROLET	VECTRA	L4 2.2L	2003	2006		ML-9018	MK-25270		
CHEVROLET	VECTRA	V6 3.2L	2003	2006		ML-9018	MK-25270		
CHEVROLET	VENTURE	V6 3.4L	1997	2005		ML-3387	MK-5070		
CHEVROLET	VOLT	L4 1.4L	2011	2015		ML-3387			
CHEVROLET	W3500	V8 6.0L	2005	2005		ML-4952		MF-481	
CHEVROLET	W4500	V8 6.0L	2005	2005		ML-4952		MF-481	
CHEVROLET	ZAFIRA	L4 1.8L	2002	2006		ML-3387	MK-5970	MF-618	
CHEVROLET	ZAFIRA	L4 2.2L	2002	2007		ML-9018	MK-9684	MF-618	
CHRYSLER	200	L4 2.4L	2011	2016		ML-10060			
CHRYSLER	300	V6 2.7L	2010	2010		ML-10060	MK-9391		
CHRYSLER	300	V8 5.7L	2016	2016		ML-10060			
CHRYSLER	300C	V6 2.7L	2009	2010		ML-10060			
CHRYSLER	CIRRUS	L4 2.4L	2007	2010		ML-10060			
CHRYSLER	CIRRUS	V6 2.5L	2009	2009		ML-10060			
CHRYSLER	CIRRUS	V6 3.5L	2010	2010		ML-10060			
CHRYSLER	PACIFICA	V6 3.6L	2017	2017		ML-3614			

BRAND	MODEL	MOTOR	FROM	TO	HP	ACEITE	AIRE	COMBUSTIBLE	CABINA
CHRYSLER	PACIFICA	V6 3.8L	2008	2008		ML-3614			
CHRYSLER	PT CRUISER	L4 2.4L	2001	2010		ML-3614			
CHRYSLER	SEBRING	L4 2.4L	2007	2010		ML-10060			
CHRYSLER	SEBRING	L4 2.4L DOHC	2002	2005		ML-3614			
CHRYSLER	SEBRING	L4 2.4L VIN X	2001	2001		ML-3614			
CHRYSLER	SEBRING	V6 2.7L	2010	2010		ML-10060			
CHRYSLER	SEBRING	V6 3.5L	2010	2010		ML-10060			
CHRYSLER	TOWN & COUNTRY	L4 2.4L	2006	2006		ML-3614	MK-9401		
CHRYSLER	TOWN & COUNTRY	V6 3.6L	2011	2016		ML-3614			
CHRYSLER	TOWN & COUNTRY	V6 3.8L	2008	2010		ML-3614			
CHRYSLER	TOWN & COUNTRY	V6 4.0L	2009	2010		ML-3614			
CHRYSLER	TOWN & COUNTRY	V6 4.0L	2010	2010		ML-10060			
CHRYSLER	VOYAGER	L4 2.4L	2000	2003		ML-3614			
CHRYSLER	VOYAGER	V6 3.3L	2008	2008		ML-3614			
CHRYSLER	VOYAGER	V6 3.8L	2008	2008		ML-3614			
CHRYSLER	300	V6 3.5L	2010	2010		ML-2	MK-9391		
CHRYSLER	300	V8 5.7L	2011	2015		ML-2			
CHRYSLER	300	V8 6.1L	2011	2011		ML-2	MK-9391		
CHRYSLER	300	V8 6.4L	2012	2014		ML-2			
CHRYSLER	300C	V6 2.7L	2005	2008		ML-3614			
CHRYSLER	300C	V6 2.7L	2005	2010			MK-9391		
CHRYSLER	300C	V6 2.7L	2008	2008		ML-2			
CHRYSLER	300C	V6 3.5L	2005	2008		ML-3614			
CHRYSLER	300C	V6 3.5L	2005	2010			MK-9391		
CHRYSLER	300C	V6 3.5L	2008	2010		ML-2			
CHRYSLER	300C	V8 5.7L	2005	2008		ML-3614			
CHRYSLER	300C	V8 5.7L	2005	2010			MK-9391		
CHRYSLER	300C	V8 5.7L	2008	2012		ML-2			
CHRYSLER	300C	V8 6.1L	2005	2008		ML-3614			
CHRYSLER	300C	V8 6.1L	2005	2010			MK-9391		
CHRYSLER	300C	V8 6.1L	2008	2011		ML-2			
CHRYSLER	300M	V6 3.5L	1999	2004		ML-3614			
CHRYSLER	ASPEN	V8 4.7L	2007	2008		ML-3614			
CHRYSLER	ASPEN	V8 4.7L	2008	2009		ML-2			
CHRYSLER	ASPEN	V8 5.7L	2007	2008		ML-3614			
CHRYSLER	ASPEN	V8 5.7L	2008	2010		ML-2			
CHRYSLER	ASPEN HYBRID	V8 5.7L	2009	2009		ML-2			
CHRYSLER	CIRRUS	V6 3.0L	2003	2005		ML-3593	MK-7344		
CHRYSLER	CIRRUS	V6 3.5L	2007	2007		ML-3614			
CHRYSLER	CONCORDE	V6 2.7L	1998	2004		ML-3614			
CHRYSLER	CONCORDE	V6 3.2L	1998	2000		ML-3614			
CHRYSLER	CROSSFIRE	V6 3.2L	2004	2008		ML-9090			
CHRYSLER	PACIFICA	V6 3.5L	2004	2006		ML-3614	MK-9401		
CHRYSLER	PACIFICA	V6 3.8L	2005	2007		ML-3614			

BRAND	MODEL	MOTOR	FROM	TO	HP	ACEITE	AIRE	COMBUSTIBLE	CABINA
CHRYSLER	PACIFICA	V6 3.8L	2005	2008			MK-9401		
CHRYSLER	PACIFICA	V6 4.0L	2007	2008		ML-3614	MK-9401		
CHRYSLER	PT CRUISER	L4 1.6L	2005	2005		ML-3600			
CHRYSLER	PT CRUISER	L4 2.4L	2003	2009		ML-3600			
CHRYSLER	PT CRUISER	L4 2.4L	2006	2010			MK-7764		
CHRYSLER	SEBRING	L4 2.4L SOHC	2002	2005		ML-3593	MK-7344		
CHRYSLER	SEBRING	L4 2.4L VIN G	2001	2001		ML-3593	MK-7344		
CHRYSLER	SEBRING	V6 2.7L	2001	2008		ML-3614			
CHRYSLER	SEBRING	V6 2.7L	2008	2009		ML-2			
CHRYSLER	SEBRING	V6 3.0L	2001	2005		ML-3593	MK-7344		
CHRYSLER	SEBRING	V6 3.5L	2007	2008		ML-3614			
CHRYSLER	SEBRING	V6 3.5L	2008	2009		ML-2			
CHRYSLER	TOWN & COUNTRY	V6 3.3L	2000	2008			MK-9401		
CHRYSLER	TOWN & COUNTRY	V6 3.8L	2000	2008			MK-9401		
CHRYSLER	TOWN & COUNTRY	V6 4.0L	2008	2008		ML-3614	MK-9401		
CHRYSLER	TOWN & COUNTRY	V8 5.7L	2009	2009		ML-2			
CHRYSLER	VOYAGER	L4 2.4L	2000	2000			MK-3660		
CHRYSLER	VOYAGER	L4 2.4L	2001	2003			MK-9401		
CHRYSLER	VOYAGER	V6 3.0L	2001	2001		ML-3614	MK-9401		
CHRYSLER	VOYAGER	V6 3.3L	2000	2000			MK-3660		
CHRYSLER	VOYAGER	V6 3.3L	2000	2007		ML-3614			
CHRYSLER	VOYAGER	V6 3.3L	2000	2008			MK-9401		
CHRYSLER	VOYAGER	V6 3.8L	2000	2000			MK-3660		
CHRYSLER	VOYAGER	V6 3.8L	2000	2005		ML-3614			
CHRYSLER	VOYAGER	V6 3.8L	2001	2008			MK-9401		
CHRYSLER	VOYAGER	V6 4.0L	2008	2008		ML-3614			
DODGE	AVENGER	L4 2.0L	2010	2010		ML-10060			
DODGE	AVENGER	L4 2.4L	2008	2014		ML-10060			
DODGE	AVENGER	V6 2.7L	2010	2010		ML-10060			
DODGE	AVENGER	V6 3.5L	2010	2010		ML-10060			
DODGE	CALIBER	L4 1.8L	2006	2010		ML-10060	MK-10118		
DODGE	CALIBER	L4 2.0L	2006	2012		ML-10060			
DODGE	CALIBER	L4 2.4L	2006	2012		ML-10060			
DODGE	CARAVAN	V6 3.6L	2011	2013		ML-3614			
DODGE	CARAVAN	V6 3.8L	2008	2010		ML-3614			
DODGE	CARAVAN	V6 4.0L	2009	2010		ML-3614			
DODGE	CARAVAN	V6 4.0L	2010	2010		ML-10060			
DODGE	CHALLENGER	V6 3.5L	2010	2010		ML-10060			
DODGE	CHALLENGER	V8 5.7L	2016	2016		ML-10060			
DODGE	CHARGER	V6 2.7L	2009	2010		ML-10060			
DODGE	CHARGER	V8 5.7L	2016	2016		ML-10060			
DODGE	DAKOTA	V6 3.7L	2009	2011		ML-10060			
DODGE	DART	L4 1.4L	2016	2016		ML-10060			
DODGE	DART	L4 2.0L	2013	2016		ML-10060			

BRAND	MODEL	MOTOR	FROM	TO	HP	ACEITE	AIRE	COMBUSTIBLE	CABINA
DODGE	DART	L4 2.4L	2013	2015		ML-10060			
DODGE	DURANGO	V6 3.7L	2009	2009		ML-10060			
DODGE	DURANGO	V8 5.7L	2016	2016		ML-10060			
DODGE	GRAND CARAVAN	V6 3.6L	2011	2016		ML-3614			
DODGE	GRAND CARAVAN	V6 3.8L	2007	2010		ML-3614			
DODGE	GRAND CARAVAN	V6 4.0L	2009	2010		ML-10060			
DODGE	GRAND CARAVAN	V6 4.0L	2010	2010		ML-3614			
DODGE	JOURNEY	L4 2.4L	2009	2016		ML-10060			
DODGE	JOURNEY	V6 3.5L	2009	2010		ML-10060			
DODGE	MAGNUM	V6 2.7L	2009	2009		ML-10060			
DODGE	NITRO	V6 3.7L	2009	2011		ML-10060			
DODGE	NITRO	V6 4.0L	2009	2011		ML-10060			
DODGE	RAM	V6 3.7L	2009	2012		ML-10060			
DODGE	RAM	V8 4.7L	2010	2010		ML-10060			
DODGE	RAM	V8 5.7L	2013	2014		ML-10060			
DODGE	RAM	V8 6.4L	2014	2014		ML-10060			
DODGE	RAM CARGO VAN	V6 3.6L	2012	2012		ML-3614			
DODGE	ATOS	L4 1.0L	2001	2004		ML-6607			
DODGE	ATOS	L4 1.1L	2005	2012		ML-6607	MK-29058	MF-25248	
DODGE	ATTITUDE	3 CIL 1.2L	2015	2015		ML-3593			
DODGE	ATTITUDE	L4 1.4L	2006	2011		ML-3593	MK-26123		
DODGE	ATTITUDE	L4 1.6L	2006	2011		ML-3593	MK-26123		
DODGE	AVENGER	V6 2.7L	2008	2008		ML-3614			
DODGE	AVENGER	V6 2.7L	2008	2009		ML-2			
DODGE	AVENGER	V6 3.5L	2008	2008		ML-3614			
DODGE	AVENGER	V6 3.5L	2008	2009		ML-2			
DODGE	CALIBER	L4 2.0L	2006	2010			MK-10118		
DODGE	CALIBER	L4 2.4L	2006	2010			MK-10118		
DODGE	CALIBER	L4 2.4L TURBO	2008	2009		ML-2			
DODGE	CARAVAN	L4 2.4L	2000	2007			MK-9401		
DODGE	CARAVAN	L4 2.4L	2004	2004		ML-3614			
DODGE	CARAVAN	V6 3.0L	2000	2000			MK-9401		
DODGE	CARAVAN	V6 3.3L	2000	2008			MK-9401		
DODGE	CARAVAN	V6 3.5L	2001	2001		ML-3614			
DODGE	CARAVAN	V6 3.8L	2000	2008			MK-9401		
DODGE	CARAVAN	V6 4.0L	2008	2008		ML-3614	MK-9401		
DODGE	CHALLENGER	V6 3.5L	2009	2009		ML-2			
DODGE	CHALLENGER	V6 3.5L	2009	2010			MK-9391		
DODGE	CHALLENGER	V8 5.7L	2008	2010			MK-9391		
DODGE	CHALLENGER	V8 5.7L	2008	2015		ML-2			
DODGE	CHALLENGER	V8 6.1L	2008	2010			MK-9391		
DODGE	CHALLENGER	V8 6.1L	2008	2011		ML-2			
DODGE	CHALLENGER	V8 6.2L	2015	2015		ML-2			
DODGE	CHALLENGER	V8 6.4L	2011	2015		ML-2			

BRAND	MODEL	MOTOR	FROM	TO	HP	ACEITE	AIRE	COMBUSTIBLE	CABINA
DODGE	CHARGER	V6 2.7L	2006	2008		ML-3614			
DODGE	CHARGER	V6 2.7L	2006	2010			MK-9391		
DODGE	CHARGER	V6 2.7L	2008	2008		ML-2			
DODGE	CHARGER	V6 3.5L	2006	2008		ML-3614			
DODGE	CHARGER	V6 3.5L	2006	2010			MK-9391		
DODGE	CHARGER	V6 3.5L	2008	2010		ML-2			
DODGE	CHARGER	V8 5.7L	2006	2008		ML-3614			
DODGE	CHARGER	V8 5.7L	2006	2010			MK-9391		
DODGE	CHARGER	V8 5.7L	2008	2015		ML-2			
DODGE	CHARGER	V8 6.1L	2006	2008		ML-3614			
DODGE	CHARGER	V8 6.1L	2006	2011			MK-9391		
DODGE	CHARGER	V8 6.1L	2008	2011		ML-2			
DODGE	CHARGER	V8 6.2L	2015	2015		ML-2			
DODGE	CHARGER	V8 6.4L	2012	2016		ML-2			
DODGE	DAKOTA	L4 2.5L	1997	2002			MK-3901		
DODGE	DAKOTA	V6 3.7L	2004	2007			MK-3901		
DODGE	DAKOTA	V6 3.7L	2004	2008		ML-3600			
DODGE	DAKOTA	V6 3.7L	2008	2011			MK-3901		
DODGE	DAKOTA	V6 3.9L	1997	2003			MK-3901		
DODGE	DAKOTA	V8 4.7L	2000	2007			MK-3901		
DODGE	DAKOTA	V8 4.7L	2000	2008		ML-3614			
DODGE	DAKOTA	V8 4.7L	2008	2011		ML-2	MK-3901		
DODGE	DAKOTA	V8 5.2L	1997	2001			MK-3901		
DODGE	DAKOTA	V8 5.7L	2005	2005		ML-3614			
DODGE	DAKOTA	V8 5.9L	1997	2003		ML-3614	MK-3901		
DODGE	DURANGO	V6 3.7L	2004	2008		ML-3600			
DODGE	DURANGO	V8 4.7L	2001	2002				MF-1680	
DODGE	DURANGO	V8 4.7L	2001	2003			MK-3901		
DODGE	DURANGO	V8 4.7L	2001	2008		ML-3614			
DODGE	DURANGO	V8 4.7L	2008	2009		ML-2			
DODGE	DURANGO	V8 5.2L	1998	2000		ML-3614	MK-3901	MF-1680	
DODGE	DURANGO	V8 5.7L	2004	2008		ML-3614			
DODGE	DURANGO	V8 5.7L	2008	2015		ML-2			
DODGE	DURANGO	V8 5.7L	2010	2010		ML-3976			
DODGE	DURANGO	V8 5.9L	1999	2002				MF-1680	
DODGE	DURANGO	V8 5.9L	1999	2003		ML-3614	MK-3901		
DODGE	DURANGO HYBRID	V8 5.7L	2009	2009		ML-2			
DODGE	GRAND CARAVAN	L4 2.4L	2000	2007			MK-9401		
DODGE	GRAND CARAVAN	V6 3.3L	2000	2008			MK-9401		
DODGE	GRAND CARAVAN	V6 3.5L	2001	2001		ML-3614			
DODGE	GRAND CARAVAN	V6 3.8L	2000	2008			MK-9401		
DODGE	GRAND CARAVAN	V6 4.0L	2008	2008		ML-3614	MK-9401		
DODGE	H100	L4 2.4L	2003	2006		ML-3593	MK-6362		
DODGE	H100	L4 2.5L DIESEL	2007	2010		ML-42040		MF-4886	

BRAND	MODEL	MOTOR	FROM	TO	HP	ACEITE	AIRE	COMBUSTIBLE	CABINA
DODGE	H100 VAN	L4 2.5L DIESEL	2008	2010		ML-42040	MK-25252	MF-4886	
DODGE	I10	L4 1.1L	2012	2013		ML-3593	MK-38183		
DODGE	INTREPID	V6 2.7L	1998	2004		ML-3614			
DODGE	INTREPID	V6 3.2L	1998	2001		ML-3614			
DODGE	JOURNEY	V6 2.7L	2009	2009		ML-2			
DODGE	MAGNUM	V6 2.7L	2008	2008		ML-2			
DODGE	MAGNUM	V6 2.7L	2008	2009			MK-9391		
DODGE	MAGNUM	V6 3.5L	2008	2008		ML-2	MK-9391		
DODGE	MAGNUM	V8 5.7L	2008	2008		ML-3614			
DODGE	MAGNUM	V8 5.7L	2008	2009		ML-2	MK-9391		
DODGE	MAGNUM	V8 6.1L	2008	2008		ML-2	MK-9391		
DODGE	NEON	L4 2.0L	1998	1999				MF-1582	
DODGE	NEON	L4 2.0L	2000	2006			MK-8805		
DODGE	NEON	L4 2.4L	2003	2006		ML-3600	MK-8805		
DODGE	NITRO	V6 3.7L	2007	2008		ML-3600			
DODGE	NITRO	V6 3.7L	2007	2011			MK-16246		
DODGE	NITRO	V6 4.0L	2007	2008		ML-3614			
DODGE	NITRO	V6 4.0L	2007	2011			MK-16246		
DODGE	RAM	6 CIL. 6.7L DIESEL	2007	2014		ML-3976			
DODGE	RAM	V10 8.0L	2003	2003			MK-9401		
DODGE	RAM	V10 8.3L	2004	2006		ML-3614			
DODGE	RAM	V6 3.6L	2013	2014			MK-9401		
DODGE	RAM	V6 3.7L	2002	2002				MF-1680	
DODGE	RAM	V6 3.7L	2002	2008		ML-3600			
DODGE	RAM	V6 3.7L	2002	2012			MK-9401		
DODGE	RAM	V8 4.7L	2000	2000			MK-3901		
DODGE	RAM	V8 4.7L	2000	2005				MF-1680	
DODGE	RAM	V8 4.7L	2000	2008		ML-3614			
DODGE	RAM	V8 4.7L	2002	2013			MK-9401		
DODGE	RAM	V8 4.7L	2008	2013		ML-2			
DODGE	RAM	V8 5.2L	2002	2002			MK-9401		
DODGE	RAM	V8 5.7L	2003	2005				MF-1680	
DODGE	RAM	V8 5.7L	2003	2008		ML-3614			
DODGE	RAM	V8 5.7L	2003	2014			MK-9401		
DODGE	RAM	V8 5.7L	2008	2012		ML-2			
DODGE	RAM	V8 5.9L	2002	2003			MK-9401		
DODGE	RAM 4000	6 CIL. 5.9L DIESEL	2006	2010		ML-3976			
DODGE	RAM 4000	6 CIL. 6.7L DIESEL	2008	2013		ML-3976			
DODGE	RAM 4000	V8 5.7L	2005	2005				MF-1680	
DODGE	RAM 4000	V8 5.7L	2005	2008		ML-3614			
DODGE	RAM 4000	V8 5.7L	2005	2013			MK-9401		
DODGE	RAM 4000	V8 5.7L	2008	2013		ML-2			
DODGE	RAM 4000	V8 5.9L	1997	2002				MF-1680	
DODGE	STRATUS	L4 2.4L	2005	2006		ML-3593	MK-7344		



BRAND	MODEL	MOTOR	FROM	TO	HP	ACEITE	AIRE	COMBUSTIBLE	CABINA
DODGE	STRATUS	V6 3.0L	2001	2005		ML-3593	MK-7344	MF-1582	
DODGE	VAN 1000	L4 2.4L	2008	2010		ML-3593		MF-6680	
DODGE	VERNA	L4 1.5L	2004	2006		ML-3593	MK-8970	MF-90122	
DODGE	VERNA	L4 1.6L	2004	2006		ML-3593	MK-8970	MF-90122	
DODGE	VIPER	V10 8.3L	2003	2007		ML-3614			
DODGE	VIPER	V10 8.4L	2009	2015		ML-2			
FIAT	500X	L4 1.4L TURBO	2016	2016		ML-10060			
FIAT	500	L4 1.4L	2009	2009		ML-3593			
FIAT	DUCATO	L4 3.0L	2008	2009				MF-2000	
FIAT	GRANDE PUNTO	L4 1.4L	2007	2008				MF-618	
FIAT	GRANDE PUNTO	L4 1.4L	2007	2009		ML-3593			
FIAT	IDEA ADVENTURE	L4 1.8L	2008	2008		ML-3387		MF-618	
FIAT	PALIO 1.8R	L4 1.8L	2007	2008		ML-3387		MF-618	
FIAT	PALIO ADVENTURE	L4 1.6L	2004	2005		ML-2849			
FIAT	PALIO ADVENTURE	L4 1.8L	2006	2008		ML-3387			
FIAT	PALIO HATCHBACK	L4 1.8L	2006	2008		ML-3387		MF-618	
FIAT	PALIO SEDAN	L4 1.6L	2004	2005		ML-2849		MF-618	
FIAT	PALIO SEDAN	L4 1.8L	2006	2008		ML-3387		MF-618	
FIAT	PANDA	L4 1.2L	2011	2011		ML-3593			
FIAT	STILO SCHUMACHER	L5 2.4L	2007	2008		ML-2849			
FIAT	STRADA ADVENTURE	L4 1.8L	2007	2008		ML-3387		MF-618	
FIAT	UNO	L4 1.4L	2014	2015		ML-3593			
FORD	C-MAX HYBRID	L4 2.0L	2013	2016		ML-3614			
FORD	CROWN VICTORIA	V8 4.6L	2009	2011		ML-3614			
FORD	E-150	V8 4.6L	2014	2014		ML-10060	MK-8004	MF-986	
FORD	E-150	V8 5.4L	2014	2014		ML-10060	MK-8004	MF-986	
FORD	E-250	V8 4.6L	2014	2014		ML-10060	MK-8004	MF-986	
FORD	E-250	V8 5.4L	2014	2014		ML-10060	MK-8004	MF-986	
FORD	E-350	V10 6.8L	2014	2016		ML-10060	MK-8004	MF-986	
FORD	E-350	V8 5.4L	2014	2016		ML-10060	MK-8004	MF-986	
FORD	E-450	V10 6.8L	2014	2014		ML-10060	MK-8004	MF-986	
FORD	E-450	V8 5.4L	2014	2015		ML-10060	MK-8004	MF-986	
FORD	ECOSPORT	L4 2.0L	2003	2015		ML-3614		MF-986	
FORD	ECOSPORT	L4 2.0L	2007	2010			MK15728		
FORD	EDGE	L4 2.0L	2012	2016		ML-3614	MK-52045		
FORD	EDGE	V6 3.5L	2009	2016		ML-10060			
FORD	EDGE	V6 3.7L	2011	2014		ML-10060	MK-52045		
FORD	ESCAPE	L4 1.5L	2017	2017		ML-3614			
FORD	ESCAPE	L4 1.6L	2013	2016		ML-3614			
FORD	ESCAPE	L4 2.0L	2005	2017		ML-3614			
FORD	ESCAPE	L4 2.3L	2005	2008		ML-3614	MK-8997	MF-800	
FORD	ESCAPE	L4 2.5L	2009	2017		ML-3614			
FORD	ESCAPE	V6 3.0L	2009	2012		ML-10060		MF-3521	
FORD	ESCAPE HYBRID	L4 2.5L	2009	2012		ML-3614		MF-3521	

BRAND	MODEL	MOTOR	FROM	TO	HP	ACEITE	AIRE	COMBUSTIBLE	CABINA
FORD	EXPEDITION	V6 3.5L	2015	2017		ML-10060	MK-95334		
FORD	EXPLORER	L4 2.0L	2012	2015		ML-3614	MK-52045		
FORD	EXPLORER	L4 2.3L	2016	2017		ML-3614	MK-52045		
FORD	EXPLORER	V6 3.5L	2011	2017		ML-10060	MK-52045		
FORD	F SERIES	V6 3.5L	2011	2013		ML-10060	MK-95334		
FORD	F SERIES	V6 3.7L	2011	2013		ML-10060	MK-95334		
FORD	F SERIES	V8 5.0L	2011	2013		ML-10060	MK-95334		
FORD	F-150	V6 3.5L	2014	2016		ML-10060	MK-95334		
FORD	F-150	V6 3.7L	2014	2014		ML-10060	MK-95334		
FORD	F-150	V8 5.0L	2014	2016		ML-10060	MK-95334		
FORD	F-150	V8 6.2L	2014	2014		ML-10060	MK-95334		
FORD	F-250	V8 6.2L	2014	2016		ML-10060	MK-95334		
FORD	F-350	V8 6.2L	2014	2016		ML-10060	MK-95334		
FORD	FIESTA	3 CIL. 1.0L	2014	2016		ML-3614			
FORD	FIESTA	L4 1.6L	2011	2016		ML-3614			
FORD	FIESTA	L4 1.6L TURBO	2014	2016		ML-3614			
FORD	FIESTA HATCHBACK	L4 1.3L	1998	2002		ML-3614	MK-5682	MF-3526	MC-16462
FORD	FIESTA HATCHBACK	L4 1.4L	1998	2000		ML-3614	MK-5682	MF-3526	MC-16462
FORD	FIESTA HATCHBACK	L4 1.6L	2001	2007		ML-3614			
FORD	FIESTA SEDAN	L4 1.6L	2005	2010		ML-3614	MK-15920	MF-986	
FORD	FLEX	V6 3.5L	2009	2016		ML-10060	MK-52045		
FORD	FOCUS	3 CIL. 1.0L	2015	2017		ML-3614			
FORD	FOCUS	L4 2.0L	2000	2017		ML-3614			
FORD	FOCUS	L4 2.0L TURBO	2015	2016		ML-3614			
FORD	FOCUS	L4 2.3L	2003	2007		ML-3614		MF-986	MC-67836C
FORD	FUSION	L4 1.5L	2014	2017		ML-3614			
FORD	FUSION	L4 1.6L	2013	2017		ML-3614			
FORD	FUSION	L4 2.0L	2013	2017		ML-3614			
FORD	FUSION	L4 2.3L	2006	2008		ML-3614			
FORD	FUSION	L4 2.5L	2010	2017		ML-3614			
FORD	FUSION	V6 3.0L	2008	2012		ML-10060			
FORD	FUSION	V6 3.5L	2010	2012		ML-10060	MK-52045		
FORD	FUSION HYBRID	L4 2.0L	2013	2016		ML-3614			
FORD	FUSION HYBRID	L4 2.5L	2010	2012		ML-3614			
FORD	LOBO	V6 3.5L	2015	2015		ML-10060	MK-95334		
FORD	LOBO	V8 5.0L	2015	2015		ML-10060	MK-95334		
FORD	MONDEO	L4 2.0L	2001	2007		ML-3614	MK-82139		
FORD	MUSTANG	L4 2.3L	2015	2017		ML-3614			
FORD	MUSTANG	V6 3.7L	2011	2017		ML-10060			
FORD	MUSTANG	V8 5.0L	2011	2017		ML-10060			
FORD	POLICE INTERCEPTOR SEDAN	L4 2.0L	2014	2016		ML-3614	MK-52045		
FORD	POLICE INTERCEPTOR SEDAN	V6 3.5L	2014	2016		ML-10060	MK-52045		
FORD	POLICE INTERCEPTOR SEDAN	V6 3.7L	2014	2016		ML-10060	MK-52045		
FORD	POLICE INTERCEPTOR UTILITY	V6 3.5L	2014	2016		ML-10060	MK-52045		

BRAND	MODEL	MOTOR	FROM	TO	HP	ACEITE	AIRE	COMBUSTIBLE	CABINA
FORD	POLICE INTERCEPTOR UTILITY	V6 3.7L	2013	2016		ML-10060	MK-52045		
FORD	RANGER	L4 2.3L	2006	2012		ML-3614			
FORD	RANGER	L4 2.5L	2015	2015		ML-3614			
FORD	TAURUS	L4 2.0L	2013	2016		ML-3614	MK-52045		
FORD	TAURUS	V6 3.5L	2009	2016		ML-10060			
FORD	TAURUS	V6 3.7L	2015	2015		ML-10060	MK-52045		
FORD	TAURUS X	V6 3.5L	2009	2009		ML-10060			
FORD	TRANSIT 150	5 CIL. 3.2L DIESEL	2015	2016		ML-10060			
FORD	TRANSIT 150	V6 3.5L	2015	2016		ML-10060			
FORD	TRANSIT 150	V6 3.7L	2015	2016		ML-10060			
FORD	TRANSIT 250	5 CIL. 3.2L DIESEL	2015	2016		ML-10060			
FORD	TRANSIT 250	V6 3.5L	2015	2016		ML-10060			
FORD	TRANSIT 250	V6 3.7L	2015	2016		ML-10060			
FORD	TRANSIT 350	5 CIL. 3.2L DIESEL	2015	2016		ML-10060			
FORD	TRANSIT 350	V6 3.5L	2015	2016		ML-10060			
FORD	TRANSIT 350	V6 3.7L	2015	2016		ML-10060			
FORD	TRANSIT 350 HD	5 CIL. 3.2L DIESEL	2015	2016		ML-10060			
FORD	TRANSIT 350 HD	V6 3.5L	2015	2016		ML-10060			
FORD	TRANSIT 350 HD	V6 3.7L	2015	2016		ML-10060			
FORD	TRANSIT CONNECT	L4 1.6L	2014	2017		ML-3614			
FORD	TRANSIT CONNECT	L4 2.0L	2010	2013		ML-3614			
FORD	TRANSIT CONNECT	L4 2.5L	2014	2017		ML-3614			
FORD	CLUB WAGON	V6 4.2L	1997	2003		ML-3600	MK-8004	MF-3521	
FORD	CLUB WAGON	V8 5.4L	1997	1998		ML-2	MK-8004	MF-3521	
FORD	CLUB WAGON	V8 5.4L	1998	1998		ML-8			
FORD	CONTOUR	L4 2.0L	1997	2002		ML-5552			
FORD	COURIER	L4 1.6L	2001	2007					MC-12021
FORD	COURIER	L4 1.6L	2001	2010		ML-3600	MK-5682	MF-3521	
FORD	CROWN VICTORIA	V8 4.6L	1998	2011				MF-986	
FORD	E SERIES (VANS)	V10 6.8L	1997	1998			MK-7756		
FORD	E SERIES (VANS)	V10 6.8L	1997	2002				MF-3521	
FORD	E SERIES (VANS)	V10 6.8L	1997	2013		ML-2	MK-8004		
FORD	E SERIES (VANS)	V10 6.8L	1999	2004					MC-12021
FORD	E SERIES (VANS)	V10 6.8L	2003	2013				MF-986	
FORD	E SERIES (VANS)	V10 6.8L	2009	2009			MK-95334		
FORD	E SERIES (VANS)	V6 4.2L	1997	2001				MF-3521	
FORD	E SERIES (VANS)	V6 4.2L	1997	2005		ML-3600	MK-8004		
FORD	E SERIES (VANS)	V6 4.2L	1998	1998			MK-7756		
FORD	E SERIES (VANS)	V6 4.2L	2000	2005				MF-986	
FORD	E SERIES (VANS)	V6 4.2L	2005	2005					MC-12021
FORD	E SERIES (VANS)	V8 4.6L	1997	1997			MK-7756		
FORD	E SERIES (VANS)	V8 4.6L	1997	2002				MF-3521	
FORD	E SERIES (VANS)	V8 4.6L	1997	2013		ML-2	MK-8004		
FORD	E SERIES (VANS)	V8 4.6L	2003	2013				MF-986	

BRAND	MODEL	MOTOR	FROM	TO	HP	ACEITE	AIRE	COMBUSTIBLE	CABINA
FORD	E SERIES (VANS)	V8 5.4L	1997	2002				MF-3521	
FORD	E SERIES (VANS)	V8 5.4L	1997	2006					MC-12021
FORD	E SERIES (VANS)	V8 5.4L	1997	2013		ML-2	MK-8004		
FORD	E SERIES (VANS)	V8 5.4L	1998	1998			MK-7756		
FORD	E SERIES (VANS)	V8 5.4L	2003	2013				MF-986	
FORD	E SERIES (VANS)	V8 5.4L	2005	2007			MK-9687		
FORD	E SERIES (VANS)	V8 5.4L	2008	2008			MK-95334		
FORD	E SERIES (VANS)	V8 6.0L DIESEL	2004	2004					MC-12021
FORD	E SERIES (VANS)	V8 7.3L DIESEL	1998	1998			MK-7756		
FORD	E SERIES (VANS)	V8 7.3L DIESEL	1999	2004					MC-12021
FORD	ECOSPORT	L4 2.0L	2003	2011			MK-7020		
FORD	EDGE	V6 2.7L	2015	2016			MK-52045		
FORD	EDGE	V6 2.7L	2016	2016				MF-1083	
FORD	EDGE	V6 3.5L	2007	2009		ML-3600			
FORD	EDGE	V6 3.5L	2007	2016			MK-52045		
FORD	EDGE	V6 3.5L	2016	2016				MF-1083	
FORD	ESCAPE	L4 2.0L	2001	2004		ML-5552			
FORD	ESCAPE	L4 2.0L	2001	2005			MK-8997	MF-800	
FORD	ESCAPE	L4 2.3L	2006	2008		ML-321			
FORD	ESCAPE	L4 2.5L	2009	2009		ML-321			
FORD	ESCAPE	L4 2.5L	2009	2012			MK-8997		
FORD	ESCAPE	L4 2.5L	2009	2014				MF-3521	
FORD	ESCAPE	V6 3.0L	2001	2008		ML-2	MK-8997	MF-800	
FORD	ESCAPE HYBRID	L4 2.3L	2005	2008		ML-321		MF-800	
FORD	ESCAPE HYBRID	L4 2.5L	2009	2009		ML-321			
FORD	ESCORT	L4 2.0L DOHC	1997	2003		ML-5552	MK-5357		
FORD	ESCORT	L4 2.0L DOHC	2000	2002					MC-67836C
FORD	ESCORT	L4 2.0L DOHC	2003	2003				MF-3521	
FORD	ESCORT	L4 2.0L SOHC	1997	2003		ML-3600	MK-5357		
FORD	ESCORT	L4 2.0L SOHC	2000	2001					MC-67836C
FORD	EXCURSION	V10 6.8L	1999	2004				MF-3521	
FORD	EXCURSION	V10 6.8L	1999	2005		ML-2	MK-8004		
FORD	EXCURSION	V8 5.4L	1999	1999		ML-2	MK-8004	MF-986	
FORD	EXCURSION	V8 7.3L DIESEL	2000	2001			MK-8243		
FORD	EXPEDITION	V6 3.5L	2015	2016				MF-1036	
FORD	EXPEDITION	V8 4.6L	1997	2004				MF-3521	
FORD	EXPEDITION	V8 4.6L	1997	2006		ML-2	MK-8004		MC-12021
FORD	EXPEDITION	V8 4.6L	2000	2006				MF-986	
FORD	EXPEDITION	V8 4.6L	2005	2005				MF-1083	
FORD	EXPEDITION	V8 5.4L	1997	2003			MK-8004		
FORD	EXPEDITION	V8 5.4L	1997	2005				MF-986	MC-12021
FORD	EXPEDITION	V8 5.4L	1997	2014		ML-2			
FORD	EXPEDITION	V8 5.4L	2004	2006			MK-9687		
FORD	EXPEDITION	V8 5.4L	2006	2006		ML-8			

BRAND	MODEL	MOTOR	FROM	TO	HP	ACEITE	AIRE	COMBUSTIBLE	CABINA
FORD	EXPEDITION	V8 5.4L	2007	2014			MK-95334	MF-1036	
FORD	EXPLORER	V6 4.0L	1997	1998			MK-8141		
FORD	EXPLORER	V6 4.0L	1997	2001			MK-8243		
FORD	EXPLORER	V6 4.0L	2001	2001				MF-986	
FORD	EXPLORER	V6 4.0L	2001	2010		ML-2			
FORD	EXPLORER	V6 4.0L	2002	2003				MF-1036	
FORD	EXPLORER	V6 4.0L	2002	2010			MK-9332		
FORD	EXPLORER	V6 4.0L	2004	2010				MF-1083	
FORD	EXPLORER	V8 4.6L	2002	2002				MF-1036	
FORD	EXPLORER	V8 4.6L	2002	2005			MK-9332		
FORD	EXPLORER	V8 4.6L	2002	2010		ML-2			
FORD	EXPLORER	V8 4.6L	2003	2010				MF-1083	
FORD	EXPLORER	V8 4.6L	2004	2004				MF-3521	
FORD	EXPLORER	V8 4.6L	2006	2010			MK-1780		
FORD	EXPLORER	V8 5.0L	1997	2002			MK-8243		
FORD	EXPLORER	V8 5.0L	1999	2002				MF-986	
FORD	EXPLORER SPORT TRAC	V6 4.0L	2002	2002				MF-1036	
FORD	EXPLORER SPORT TRAC	V6 4.0L	2002	2003			MK-8243		
FORD	EXPLORER SPORT TRAC	V6 4.0L	2002	2010		ML-2			
FORD	EXPLORER SPORT TRAC	V6 4.0L	2003	2010				MF-1083	
FORD	EXPLORER SPORT TRAC	V6 4.0L	2007	2010			MK-9332		
FORD	EXPLORER SPORT TRAC	V8 4.6L	2007	2010		ML-2	MK-1780	MF-1083	
FORD	F SERIES	V10 6.8L	1999	2000			MK-8004	MF-3521	MC-12021
FORD	F SERIES	V10 6.8L	1999	2012		ML-2			
FORD	F SERIES	V10 6.8L	2008	2012			MK-95334	MF-1083	
FORD	F SERIES	V6 3.7L	2012	2013				MF-1083	
FORD	F SERIES	V6 4.2L	1997	1997			MK-7756		
FORD	F SERIES	V6 4.2L	1997	1998				MF-3521	
FORD	F SERIES	V6 4.2L	1997	2008		ML-3600	MK-8004		MC-12021
FORD	F SERIES	V6 4.2L	1999	2006				MF-986	
FORD	F SERIES	V6 4.2L	2007	2008				MF-1083	
FORD	F SERIES	V8 4.6L	1997	1999				MF-3521	
FORD	F SERIES	V8 4.6L	1997	2008			MK-8004		MC-12021
FORD	F SERIES	V8 4.6L	1997	2010		ML-2			
FORD	F SERIES	V8 4.6L	2000	2006				MF-986	
FORD	F SERIES	V8 4.6L	2004	2008		ML-3600			
FORD	F SERIES	V8 4.6L	2007	2010				MF-1083	
FORD	F SERIES	V8 4.6L	2009	2010			MK-95334		
FORD	F SERIES	V8 5.0L	2012	2013				MF-1083	
FORD	F SERIES	V8 5.4L	1997	1997			MK-7756		
FORD	F SERIES	V8 5.4L	1997	2002				MF-3521	
FORD	F SERIES	V8 5.4L	1997	2004			MK-8004		
FORD	F SERIES	V8 5.4L	1997	2007					MC-12021
FORD	F SERIES	V8 5.4L	1997	2010		ML-2			

BRAND	MODEL	MOTOR	FROM	TO	HP	ACEITE	AIRE	COMBUSTIBLE	CABINA
FORD	F SERIES	V8 5.4L	2000	2008				MF-986	
FORD	F SERIES	V8 5.4L	2004	2008			MK-9687		
FORD	F SERIES	V8 5.4L	2007	2010				MF-1083	
FORD	F SERIES	V8 5.4L	2008	2010			MK-95334		
FORD	F SERIES	V8 5.8L	1997	1997					MC-12021
FORD	F SERIES	V8 6.0L DIESEL	2003	2004					MC-12021
FORD	F SERIES	V8 6.2L	2011	2013		ML-2	MK-95334	MF-1083	
FORD	F SERIES	V8 7.3L DIESEL	1997	2000					MC-12021
FORD	F SERIES	V8 7.3L DIESEL	1999	2000			MK-8243		
FORD	F SERIES	V8 7.5L	1997	1997					MC-12021
FORD	F SERIES SUPER DUTY	V10 6.8L	2001	2003			MK-6591		
FORD	F SERIES SUPER DUTY	V10 6.8L	2001	2004			MK-8004	MF-3521	MC-12021
FORD	F SERIES SUPER DUTY	V10 6.8L	2001	2013		ML-2			
FORD	F SERIES SUPER DUTY	V10 6.8L	2005	2013				MF-1083	
FORD	F SERIES SUPER DUTY	V10 6.8L	2009	2013			MK-95334		
FORD	F SERIES SUPER DUTY	V8 5.4L	2001	2004			MK-8004	MF-3521	
FORD	F SERIES SUPER DUTY	V8 5.4L	2001	2007					MC-12021
FORD	F SERIES SUPER DUTY	V8 5.4L	2001	2010		ML-2			
FORD	F SERIES SUPER DUTY	V8 5.4L	2005	2007			MK-9687		
FORD	F SERIES SUPER DUTY	V8 5.4L	2005	2010				MF-1083	
FORD	F SERIES SUPER DUTY	V8 5.4L	2008	2010			MK-95334		
FORD	F SERIES SUPER DUTY	V8 6.0L DIESEL	2003	2004					MC-12021
FORD	F SERIES SUPER DUTY	V8 6.2L	2011	2011			MK-95334		
FORD	F SERIES SUPER DUTY	V8 6.2L	2011	2012		ML-2			
FORD	F SERIES SUPER DUTY	V8 7.3L DIESEL	1999	1999			MK-59160		
FORD	F SERIES SUPER DUTY	V8 7.3L DIESEL	1999	2003			MK-8243		
FORD	F SERIES SUPER DUTY	V8 7.3L DIESEL	2001	2003					MC-12021
FORD	F-150	V6 2.7L	2015	2016			MK-95334		
FORD	F-450	V10 6.8L	2010	2014				MF-1083	
FORD	F-450	V10 6.8L	2010	2015		ML-2	MK-95334		
FORD	F-450	V8 5.4L	2007	2007		ML-2	MK-9687	MF-1083	
FORD	F-450	V8 6.2L	2011	2011			MK-95334		
FORD	F-450	V8 6.2L	2011	2012		ML-2			
FORD	F-450	V8 7.3L DIESEL	1999	1999			MK-59160		
FORD	F53	V10 6.8L	2014	2016		ML-2			
FORD	F-550	V10 6.8L	2010	2013				MF-1083	
FORD	F-550	V10 6.8L	2010	2015		ML-2	MK-95334		
FORD	F-550	V8 5.4L	2007	2007		ML-2	MK-9687	MF-1083	
FORD	F-550	V8 6.2L	2011	2011			MK-95334		
FORD	F-550	V8 6.2L	2011	2012		ML-2			
FORD	F-550	V8 7.3L DIESEL	1999	1999			MK-59160		
FORD	F-550	V8 7.3L DIESEL	1999	2001			MK-8243		
FORD	FIESTA	L4 1.6L	2011	2014			MK-26934		
FORD	FIESTA	L4 1.6L TURBO	2014	2014			MK-26934		

BRAND	MODEL	MOTOR	FROM	TO	HP	ACEITE	AIRE	COMBUSTIBLE	CABINA
FORD	FIESTA HATCHBACK	L4 1.6L	2001	2001			MK-5682	MF-3526	
FORD	FIESTA HATCHBACK	L4 1.6L	2003	2007			MK-15920	MF-986	
FORD	FIVE HUNDRED	L4 2.0L	2006	2006		ML-2		MF-986	
FORD	FIVE HUNDRED	V6 3.0L	2005	2007		ML-2		MF-986	
FORD	FIVE HUNDRED	V6 3.5L	2006	2006		ML-2			
FORD	FIVE HUNDRED	V6 3.5L	2006	2008				MF-986	
FORD	FIVE HUNDRED	V6 3.5L	2008	2008		ML-3600	MK-52045		
FORD	FLEX	V6 3.5L	2009	2009		ML-3600			
FORD	FOCUS	L4 2.0L	2000	2005		ML-5552	MK-5929		
FORD	FOCUS	L4 2.0L	2000	2007				MF-986	
FORD	FOCUS	L4 2.0L	2000	2010					MC-67836C
FORD	FOCUS	L4 2.0L	2009	2013				MF-1036	
FORD	FOCUS	L4 2.3L	2003	2004			MK-5929		
FORD	FREESTAR	V6 3.9L	2004	2005				MF-986	
FORD	FREESTAR	V6 3.9L	2004	2007		ML-3600			
FORD	FREESTAR	V6 3.9L	2006	2007				MF-1036	
FORD	FREESTAR	V6 4.2L	2004	2005				MF-986	
FORD	FREESTAR	V6 4.2L	2004	2007		ML-3600			
FORD	FREESTAR	V6 4.2L	2006	2007				MF-1036	
FORD	FREESTYLE	V6 3.0L	2005	2007		ML-2		MF-986	
FORD	FUSION	L4 2.3L	2006	2009		ML-321			
FORD	FUSION	V6 3.0L	2006	2009		ML-2			
FORD	FUSION	V6 3.0L	2006	2012			MK-19158		
FORD	GRAND MARQUIS	V8 4.6L	1998	2009				MF-986	
FORD	IKON	L4 1.6L	2000	2015		ML-3600	MK-5682	MF-3526	
FORD	KA	L4 1.6L	2000	2008		ML-5552	MK-9896	MF-986	MC-12021
FORD	LOBO	V8 4.6L	1997	2006				MF-986	
FORD	LOBO	V8 4.6L	1997	2008		ML-3600	MK-8004		
FORD	LOBO	V8 4.6L	1997	2009		ML-2			
FORD	LOBO	V8 4.6L	1998	1998				MF-3521	
FORD	LOBO	V8 4.6L	2007	2009				MF-1083	
FORD	LOBO	V8 4.6L	2009	2009			MK-95334		
FORD	LOBO	V8 5.4L	1998	1998				MF-3521	
FORD	LOBO	V8 5.4L	1998	2002			MK-8004		
FORD	LOBO	V8 5.4L	1998	2008		ML-2			
FORD	LOBO	V8 5.4L	1999	2005				MF-986	
FORD	LOBO	V8 5.4L	2003	2007		ML-3600	MK-9687		
FORD	LOBO	V8 5.4L	2006	2008				MF-1083	
FORD	LOBO	V8 5.4L	2008	2008			MK-95334		
FORD	LOBO	V8 6.2L	2014	2014		ML-2	MK-95334	MF-1083	
FORD	MARAUDER	V8 4.6L	2004	2006		ML-2	MK-5056	MF-986	
FORD	MONDEO	V6 2.5L	2001	2007		ML-2			
FORD	MONDEO	V6 2.5L	2002	2007			MK-82139		
FORD	MUSTANG	V6 3.7L	2011	2014				MF-1083	

BRAND	MODEL	MOTOR	FROM	TO	HP	ACEITE	AIRE	COMBUSTIBLE	CABINA
FORD	MUSTANG	V6 3.8L	1998	2004				MF-986	
FORD	MUSTANG	V6 3.9L	2004	2004		ML-3600		MF-986	
FORD	MUSTANG	V6 4.0L	2005	2010		ML-2	MK-9895	MF-1083	
FORD	MUSTANG	V8 4.6L	2000	2005				MF-986	
FORD	MUSTANG	V8 4.6L	2005	2009			MK-9895		
FORD	MUSTANG	V8 4.6L	2006	2010				MF-1083	
FORD	MUSTANG	V8 5.0L	2011	2014				MF-1083	
FORD	MUSTANG	V8 5.2L	2016	2016				MF-1083	
FORD	MUSTANG	V8 5.4L	2007	2013		ML-2		MF-1083	
FORD	MUSTANG	V8 5.8L	2013	2014		ML-2		MF-1083	
FORD	RANGER	L4 2.3L	2001	2001				MF-4922	
FORD	RANGER	L4 2.3L	2001	2005		ML-3600			
FORD	RANGER	L4 2.3L	2001	2012			MK-8243		
FORD	RANGER	L4 2.3L	2004	2012				MF-1036	
FORD	RANGER	L4 2.5L	1998	1998		ML-8			
FORD	RANGER	L4 2.5L	1998	1999				MF-986	
FORD	RANGER	L4 2.5L	1998	2001			MK-8243		
FORD	RANGER	L4 2.5L	1999	2001		ML-3600			
FORD	RANGER	L4 2.5L	2000	2001				MF-4922	
FORD	RANGER	V6 3.0L	1998	1999				MF-986	
FORD	RANGER	V6 3.0L	1998	2009			MK-8243		
FORD	RANGER	V6 3.0L	2000	2001				MF-4922	
FORD	RANGER	V6 3.0L	2004	2009				MF-1036	
FORD	RANGER	V6 4.0L	1998	1999				MF-986	
FORD	RANGER	V6 4.0L	1998	2012			MK-8243		
FORD	RANGER	V6 4.0L	2000	2002				MF-4922	
FORD	RANGER	V6 4.0L	2001	2012		ML-2			
FORD	RANGER	V6 4.0L	2004	2012				MF-1036	
FORD	TAURUS	V6 3.0L DOHC	2000	2007			MK-8997		
FORD	TAURUS	V6 3.0L FLEX FUEL	1999	2002			MK-8997		
FORD	TAURUS	V6 3.0L SOHC	2000	2007			MK-8997		
FORD	TAURUS	V6 3.5L	2008	2009		ML-3600			
FORD	TAURUS	V6 3.5L	2008	2016			MK-52045		
FORD	TAURUS X	V6 3.5L	2008	2009		ML-3600	MK-52045		
FORD	THUNDERBIRD	V8 3.9L	2002	2003				MF-986	
FORD	THUNDERBIRD	V8 3.9L	2004	2005				MF-1083	
FORD	TRANSIT	L4 2.2L DIESEL	2007	2010		ML-9814	MK-73667		
FORD	WINDSTAR	V6 3.0L	1999	2000				MF-986	
FORD	WINDSTAR	V6 3.8L	1999	2003				MF-986	
HONDA	CR-Z	L4 1.5L	2011	2011		ML-10060			
HONDA	ACCORD	L4 2.0L	2017	2017		ML-3593			
HONDA	ACCORD	L4 2.3L	1998	2002		ML-3593	MK-6807	MF-7599	
HONDA	ACCORD	L4 2.4L	2003	2017		ML-3593			
HONDA	ACCORD	V6 3.0L	1998	2002				MF-6826	



BRAND	MODEL	MOTOR	FROM	TO	HP	ACEITE	AIRE	COMBUSTIBLE	CABINA
HONDA	ACCORD	V6 3.0L	1998	2007		ML-3593			
HONDA	ACCORD	V6 3.0L	2003	2007					MC-35422
HONDA	ACCORD	V6 3.5L	2008	2017		ML-3593			
HONDA	ACCORD CROSSTOUR	V6 3.5L	2010	2012		ML-3593			
HONDA	ACCORD HYBRID	L4 2.0L	2014	2015		ML-3593			
HONDA	CITY	L4 1.5L	2010	2011			MK-94973		
HONDA	CITY	L4 1.5L	2010	2015		ML-3593			
HONDA	CIVIC	L4 1.7L	2001	2001		ML-6607			
HONDA	CIVIC	L4 1.7L	2001	2005			MK-8911		MC-35422
HONDA	CIVIC	L4 1.7L	2002	2005		ML-3593			
HONDA	CIVIC	L4 1.8L	2006	2014			MK-80146		
HONDA	CIVIC	L4 1.8L	2006	2015		ML-3593			
HONDA	CIVIC	L4 2.0L	2002	2002			MK-8911		
HONDA	CIVIC	L4 2.0L	2002	2004					MC-35422
HONDA	CIVIC	L4 2.0L	2002	2016		ML-3593			
HONDA	CIVIC	L4 2.0L TURBO	2016	2016		ML-3593			
HONDA	CIVIC	L4 2.4L	2012	2015		ML-3593			
HONDA	CIVIC HYBRID	L4 1.3L	2002	2005					MC-35422
HONDA	CIVIC HYBRID	L4 1.3L	2002	2011		ML-3593			
HONDA	CIVIC HYBRID	L4 1.5L	2012	2015		ML-3593			
HONDA	CROSSTOUR	L4 2.4L	2013	2015		ML-3593			
HONDA	CROSSTOUR	V6 3.5L	2013	2015		ML-3593			
HONDA	CR-V	L4 2.0L	1997	2001		ML-6607	MK-7764	MF-7599	
HONDA	CR-V	L4 2.4L	2002	2004		ML-3593		MF-7599	
HONDA	CR-V	L4 2.4L	2002	2006					MC-35422
HONDA	CR-V	L4 2.4L	2005	2016		ML-3593			
HONDA	CR-Z	L4 1.5L	2011	2016		ML-3593			
HONDA	ELEMENT	L4 2.4L	2003	2010					MC-35422
HONDA	ELEMENT	L4 2.4L	2003	2011		ML-3593			
HONDA	FIT	L4 1.5L	2006	2008			MK-72373		
HONDA	FIT	L4 1.5L	2006	2016		ML-3593			
HONDA	FIT	L4 1.5L	2009	2014			MK-94973		
HONDA	FIT	L4 1.8L	2008	2008		ML-3593	MK-72373		
HONDA	HR-V	L4 1.5L	2016	2016		ML-3593			
HONDA	INSIGHT	L4 1.3L	2010	2014		ML-3593			
HONDA	ODYSSEY	L4 2.3L	1998	1998		ML-3593	MK-7420	MF-7599	
HONDA	ODYSSEY	V6 3.5L	1999	2016		ML-3593			
HONDA	ODYSSEY	V6 3.5L	2000	2004		ML-3593		MF-7599	
HONDA	PILOT	V6 3.5L	2003	2004		ML-3593			
HONDA	PILOT	V6 3.5L	2005	2016		ML-3593			
HONDA	PRELUDE	L4 2.2L	1998	2001				MF-7599	
HONDA	RIDGELINE	V6 3.5L	2007	2017		ML-3593			
HONDA	S2000	L4 2.0L	2000	2001		ML-3593			
HONDA	S2000	L4 2.0L	2002	2003		ML-6607			

BRAND	MODEL	MOTOR	FROM	TO	HP	ACEITE	AIRE	COMBUSTIBLE	CABINA
HONDA	S2000	L4 2.2L	2002	2002		ML-3593			
HONDA	S2000	L4 2.2L	2004	2009		ML-6607			
HYUNDAI	ACCENT	L4 1.5L	2000	2003		ML-3593	MK-8970		
HYUNDAI	ACCENT	L4 1.6L	2001	2005			MK-8970		
HYUNDAI	ACCENT	L4 1.6L	2001	2017		ML-3593			
HYUNDAI	ACCENT	L4 1.6L	2006	2011			MK-26123		
HYUNDAI	ACCENT	L4 1.6L	2012	2017			MK-68338		
HYUNDAI	ELANTRA	L4 1.8L	1999	2016		ML-3593			
HYUNDAI	ELANTRA	L4 2.0L	1999	2000				MF-9000	
HYUNDAI	ELANTRA	L4 2.0L	1999	2016		ML-3593			
HYUNDAI	ELANTRA	L4 2.0L	2001	2006			MK-9392		
HYUNDAI	ELANTRA	L4 2.0L	2017	2017		ML-3593			
HYUNDAI	ELANTRA	L4 2.0L TURBO	2015	2015		ML-3593			
HYUNDAI	GENESIS	L4 2.0L	2010	2014		ML-3593			
HYUNDAI	GETZ	L4 1.1L	2002	2008			MK-24086		
HYUNDAI	GETZ	L4 1.3L	2002	2005			MK-24086		
HYUNDAI	GETZ	L4 1.4L	2005	2008			MK-24086		
HYUNDAI	GETZ	L4 1.5L	2003	2008			MK-24086		
HYUNDAI	GETZ	L4 1.6L	2002	2008			MK-24086		
HYUNDAI	GRAND IIO	L4 1.2L	2015	2015		ML-3593			
HYUNDAI	IX35	L4 2.0L	2015	2015		ML-5566			
HYUNDAI	SANTA FE	L4 2.0L	2013	2016		ML-3593			
HYUNDAI	SANTA FE	L4 2.0L	2017	2017		ML-3593			
HYUNDAI	SANTA FE	L4 2.4L	2001	2016		ML-3593			
HYUNDAI	SANTA FE	L4 2.4L	2017	2017		ML-3593			
HYUNDAI	SANTA FE	V6 2.7L	2001	2009		ML-3593			
HYUNDAI	SANTA FE	V6 3.3L	2015	2015		ML-3593			
HYUNDAI	SANTA FE	V6 3.5L	2003	2006		ML-3593			
HYUNDAI	SONATA	L4 1.6L	2015	2016		ML-3593			
HYUNDAI	SONATA	L4 2.0L	2011	2016		ML-3593			
HYUNDAI	SONATA	L4 2.4L	1999	2002				MF-6680	
HYUNDAI	SONATA	L4 2.4L	1999	2016		ML-3593			
HYUNDAI	SONATA	V6 2.5L	1999	2001		ML-3593		MF-6680	
HYUNDAI	SONATA	V6 2.7L	2002	2002				MF-6680	
HYUNDAI	SONATA	V6 2.7L	2002	2005		ML-3593			
HYUNDAI	SONATA HYBRID	L4 2.0L	2016	2016		ML-3593			
HYUNDAI	SONATA HYBRID	L4 2.4L	2011	2015		ML-3593			
HYUNDAI	TIBURON	L4 1.8L	1997	1998		ML-3593			
HYUNDAI	TIBURON	L4 1.8L	1997	2000				MF-9000	
HYUNDAI	TIBURON	L4 1.8L	1999	2000		ML-3593			
HYUNDAI	TIBURON	L4 2.0L	1997	2001				MF-9000	
HYUNDAI	TIBURON	L4 2.0L	1997	2003		ML-3593			
HYUNDAI	TIBURON	L4 2.0L	1999	2008		ML-3593			
HYUNDAI	TIBURON	L4 2.0L	2003	2008			MK-9392		

BRAND	MODEL	MOTOR	FROM	TO	HP	ACEITE	AIRE	COMBUSTIBLE	CABINA
HYUNDAI	TIBURON	V6 2.7L	2003	2003		ML-3593			
HYUNDAI	TIBURON	V6 2.7L	2003	2008			MK-9392		
HYUNDAI	TIBURON	V6 2.7L	2004	2008		ML-3593			
HYUNDAI	TUCSON	L4 1.6L	2016	2016		ML-3593			
HYUNDAI	TUCSON	L4 2.0L	2005	2009			MK-8000		
HYUNDAI	TUCSON	L4 2.0L	2005	2016		ML-3593			
HYUNDAI	TUCSON	L4 2.4L	2010	2015		ML-3593			
HYUNDAI	TUCSON	V6 2.7L	2005	2009		ML-3593	MK-8000		
HYUNDAI	VELOSTER	L4 1.6L	2012	2016		ML-3593	MK-68338		
HYUNDAI	XG300	V6 3.0L	2001	2002		ML-3593		MF-6680	
HYUNDAI	XG350	V6 3.5L	2002	2005		ML-3593			
JEEP	CHEROKEE	L4 2.4L	2014	2016		ML-10060			
JEEP	COMMANDER	V6 3.7L	2009	2010		ML-10060			
JEEP	COMPASS	L4 2.0L	2007	2016		ML-10060			
JEEP	COMPASS	L4 2.4L	2007	2016		ML-10060			
JEEP	GRAND CHEROKEE	V6 3.7L	2009	2010		ML-10060			
JEEP	GRAND CHEROKEE	V8 5.7L	2016	2016		ML-10060			
JEEP	JK	V6 3.8L	2011	2011		ML-3614			
JEEP	LIBERTY	L4 1.4L	2014	2014		ML-10060			
JEEP	LIBERTY	L4 2.4L	2002	2006		ML-3614			
JEEP	LIBERTY	V6 3.7L	2008	2012		ML-10060	MK-16246		
JEEP	LJ	L4 2.4L	2004	2006		ML-3614			
JEEP	PATRIOT	L4 2.0L	2007	2016		ML-10060			
JEEP	PATRIOT	L4 2.4L	2007	2016		ML-10060			
JEEP	RENEGADE	L4 2.4L	2015	2016		ML-10060			
JEEP	TJ	L4 2.4L	2003	2006		ML-3614			
JEEP	TJ	V6 3.8L	2008	2009		ML-3614			
JEEP	WRANGLER	L4 2.4L	2006	2006		ML-3614			
JEEP	WRANGLER	L4 2.5L	2003	2005		ML-3614			
JEEP	WRANGLER	V6 3.6L	2016	2016		ML-10060			
JEEP	WRANGLER	V6 3.8L	2007	2011		ML-3614			
JEEP	YJ	L4 2.4L	2003	2006		ML-3614			
JEEP	YJ	V6 3.8L	2007	2011		ML-3614			
JEEP	CHEROKEE	L6 4.0L	1998	2001				MF-283	
JEEP	CHEROKEE	L6 4.0L	2001	2001			MK-7440		
JEEP	COMMANDER	V6 3.7L	2006	2008		ML-3600			
JEEP	COMMANDER	V6 3.7L	2006	2010			MK-18777		
JEEP	COMMANDER	V8 4.7L	2006	2008		ML-3614			
JEEP	COMMANDER	V8 4.7L	2006	2009			MK-18777		
JEEP	COMMANDER	V8 4.7L	2008	2009		ML-2			
JEEP	COMMANDER	V8 5.7L	2006	2008		ML-3614			
JEEP	COMMANDER	V8 5.7L	2006	2010			MK-18777		
JEEP	COMMANDER	V8 5.7L	2008	2010		ML-2			
JEEP	COMPASS	L4 2.0L	2007	2010			MK-10118		

BRAND	MODEL	MOTOR	FROM	TO	HP	ACEITE	AIRE	COMBUSTIBLE	CABINA
JEEP	COMPASS	L4 2.4L	2007	2010			MK-10118		
JEEP	GRAND CHEROKEE	L6 4.0L	1999	2001				MF-283	
JEEP	GRAND CHEROKEE	V6 3.0L DIESEL	2007	2009			MK-18777	MF-73138	
JEEP	GRAND CHEROKEE	V6 3.7L	2005	2008		ML-3600			
JEEP	GRAND CHEROKEE	V6 3.7L	2005	2010			MK-18777		
JEEP	GRAND CHEROKEE	V8 4.7L	1999	2002				MF-283	
JEEP	GRAND CHEROKEE	V8 4.7L	1999	2004			MK-7440		
JEEP	GRAND CHEROKEE	V8 4.7L	1999	2007		ML-3614			
JEEP	GRAND CHEROKEE	V8 4.7L	2005	2009			MK-18777		
JEEP	GRAND CHEROKEE	V8 4.7L	2009	2009		ML-2			
JEEP	GRAND CHEROKEE	V8 5.7L	2005	2008		ML-3614			
JEEP	GRAND CHEROKEE	V8 5.7L	2005	2010			MK-18777		
JEEP	GRAND CHEROKEE	V8 5.7L	2009	2015		ML-2			
JEEP	GRAND CHEROKEE	V8 6.1L	2006	2008		ML-3614			
JEEP	GRAND CHEROKEE	V8 6.1L	2006	2010			MK-18777		
JEEP	GRAND CHEROKEE	V8 6.1L	2009	2010		ML-2			
JEEP	GRAND CHEROKEE	V8 6.4L	2012	2016		ML-2			
JEEP	LIBERTY	L4 2.4L	2002	2004				MF-74058	
JEEP	LIBERTY	L4 2.5L DIESEL	2002	2002			MK-18777		
JEEP	LIBERTY	L4 2.8L DIESEL	2005	2006		ML-5552	MK-18777		
JEEP	LIBERTY	V6 3.7L	2002	2007			MK-18777	MF-74058	
JEEP	LIBERTY	V6 3.7L	2002	2008		ML-3600			
JEEP	LJ	6 CIL. 4.0L	2004	2006		ML-3614			
JEEP	PATRIOT	L4 2.0L	2007	2010			MK-10118		
JEEP	PATRIOT	L4 2.4L	2007	2010			MK-10118		
JEEP	RUBICON	6 CIL. 4.0L	2004	2004		ML-3614		MF-283	
JEEP	RUBICON	L4 2.5L	2004	2004		ML-3614		MF-283	
JEEP	WRANGLER	L4 2.5L	2005	2005			MK-3901		
KIA	AMANTI	V6 3.5L	2004	2006		ML-3593			
KIA	FORTE	L4 1.6L	2014	2016		ML-3593			
KIA	FORTE	L4 1.8L	2014	2016		ML-3593			
KIA	FORTE	L4 2.0L	2010	2016		ML-3593			
KIA	FORTE	L4 2.4L	2010	2013		ML-3593			
KIA	MAGENTIS (CANADA)	L4 2.4L	2001	2003				MF-6680	
KIA	MAGENTIS (CANADA)	L4 2.4L	2001	2010		ML-3593			
KIA	MAGENTIS (CANADA)	L4 2.4L	2007	2010			MK-76429		
KIA	MAGENTIS (CANADA)	V6 2.5L	2001	2001				MF-6680	
KIA	MAGENTIS (CANADA)	V6 2.5L	2001	2002		ML-3593			
KIA	MAGENTIS (CANADA)	V6 2.7L	2002	2003				MF-6680	
KIA	MAGENTIS (CANADA)	V6 2.7L	2002	2008		ML-3593			
KIA	MAGENTIS (CANADA)	V6 2.7L	2007	2010			MK-76429		
KIA	MAGENTIS (CANADA)	V6 2.7L	2009	2010		ML-3593			
KIA	OPTIMA	L4 1.6L	2016	2016		ML-3593			
KIA	OPTIMA	L4 2.0L	2011	2016		ML-3593			

BRAND	MODEL	MOTOR	FROM	TO	HP	ACEITE	AIRE	COMBUSTIBLE	CABINA
KIA	OPTIMA	L4 2.4L	2001	2004				MF-6680	
KIA	OPTIMA	L4 2.4L	2001	2016		ML-3593			
KIA	OPTIMA	L4 2.4L	2006	2010			MK-76429		
KIA	OPTIMA	L4 2.4L	2017	2017		ML-3593			
KIA	OPTIMA	V6 2.5L	2001	2001				MF-6680	
KIA	OPTIMA	V6 2.5L	2001	2002		ML-3593			
KIA	OPTIMA	V6 2.7L	2002	2004				MF-6680	
KIA	OPTIMA	V6 2.7L	2002	2010		ML-3593			
KIA	OPTIMA	V6 2.7L	2006	2010			MK-76429		
KIA	OPTIMA HYBRID	L4 2.4L	2011	2016		ML-3593			
KIA	RIO	L4 1.6L	2006	2011			MK-26123		
KIA	RIO	L4 1.6L	2006	2017		ML-3593			
KIA	RIO	L4 1.6L	2012	2017			MK-68338		
KIA	RIO5	L4 1.6L	2007	2011		ML-3593	MK-26123		
KIA	RONDO	L4 2.0L	2014	2015		ML-3593			
KIA	RONDO	L4 2.4L	2007	2012		ML-3593	MK-76429		
KIA	RONDO	V6 2.7L	2007	2012		ML-3593	MK-76429		
KIA	RX-V	L4 1.6L	2006	2006		ML-3593	MK-26123		
KIA	SEDONA	V6 3.5L	2002	2005		ML-3593			
KIA	SEDONA	V6 3.8L	2006	2006		ML-3593			
KIA	SEPHIA	L4 1.8L	1998	2001			MK-8548		
KIA	SORENTO	L4 2.0L	2016	2016		ML-3593			
KIA	SORENTO	L4 2.4L	2011	2016		ML-3593			
KIA	SORENTO	V6 3.5L	2003	2006		ML-3593			
KIA	SORENTO	V6 3.5L	2005	2005		ML-3593			
KIA	SOUL	L4 1.6L	2010	2016		ML-3593			
KIA	SOUL	L4 1.6L	2012	2016			MK-68338		
KIA	SOUL	L4 2.0L	2010	2016		ML-3593			
KIA	SOUL	L4 2.0L	2012	2016			MK-68338		
KIA	SPECTRA	L4 1.8L	2000	2002		ML-6607			
KIA	SPECTRA	L4 1.8L	2000	2004			MK-8548		
KIA	SPECTRA	L4 1.8L	2003	2004		ML-3593			
KIA	SPECTRA	L4 2.0L	2004	2009		ML-3593	MK-9392		
KIA	SPECTRA5	L4 2.0L	2005	2009		ML-3593			
KIA	SPORTAGE	L4 2.0L	2005	2010			MK-8000		
KIA	SPORTAGE	L4 2.0L	2005	2016		ML-3593			
KIA	SPORTAGE	L4 2.4L	2011	2016		ML-3593			
KIA	SPORTAGE	V6 2.7L	2005	2010		ML-3593	MK-8000		
MAZDA	B-2300	L4 2.3L	2006	2010		ML-3614			
MAZDA	CX-7	L4 2.3L	2010	2012		ML-3614			
MAZDA	CX-7	L4 2.5L	2010	2012		ML-3614			
MAZDA	MAZDA 3	L4 2.0L	2004	2012		ML-3614	MK-96431		
MAZDA	MAZDA 3	L4 2.0L VIN F	2013	2013		ML-3614	MK-96431		
MAZDA	MAZDA 3	L4 2.0L VIN G	2013	2013		ML-3614	MK-96431		

BRAND	MODEL	MOTOR	FROM	TO	HP	ACEITE	AIRE	COMBUSTIBLE	CABINA
MAZDA	MAZDA 3	L4 2.3L	2010	2013		ML-3614			
MAZDA	MAZDA 3	L4 2.5L	2010	2013		ML-3614	MK-96431		
MAZDA	MAZDA 5	L4 2.3L	2010	2010		ML-3614			
MAZDA	MAZDA 5	L4 2.5L	2012	2014		ML-3614			
MAZDA	MAZDA 6	L4 2.5L	2010	2013		ML-3614			
MAZDA	MAZDASPEED	L4 2.0L	2008	2010		ML-3614			
MAZDA	MAZDASPEED	L4 2.5L	2010	2010		ML-3614			
MAZDA	MAZDASPEED3	L4 2.0L	2008	2012		ML-3614	MK-96431		
MAZDA	MAZDASPEED3	L4 2.3L	2010	2012		ML-3614			
MAZDA	MAZDASPEED3	L4 2.5L	2010	2012		ML-3614	MK-96431		
MAZDA	MIATA	L4 2.0L	2006	2012		ML-3614			
MAZDA	MX-5	L4 2.0L	2006	2015		ML-3614			
MAZDA	TRIBUTE	L4 2.3L	2005	2008		ML-3614	MK-8997	MF-800	
MAZDA	TRIBUTE	L4 2.5L	2010	2011		ML-3614			
MAZDA	TRIBUTE	V6 3.0L	2009	2011		ML-10060			
MAZDA	TRIBUTE HYBRID	L4 2.5L	2010	2011		ML-3614			
MAZDA	B-2300	L4 2.3L	2001	2005		ML-3600			
MAZDA	B-2300	L4 2.3L	2001	2010			MK-8243	MF-4922	
MAZDA	B-2300	L4 2.3L	2004	2008				MF-1036	
MAZDA	B-2500	L4 2.5L	1998	1999				MF-986	
MAZDA	B-2500	L4 2.5L	1998	2001		ML-3600	MK-8243		
MAZDA	B-2500	L4 2.5L	2000	2001				MF-4922	
MAZDA	B-3000	V6 3.0L	1998	1999				MF-986	
MAZDA	B-3000	V6 3.0L	1998	2008			MK-8243		
MAZDA	B-3000	V6 3.0L	2000	2003				MF-4922	
MAZDA	B-3000	V6 3.0L	2006	2006		ML-5552			
MAZDA	B-3000	V6 3.0L	2006	2008				MF-1036	
MAZDA	B-4000	V6 4.0L	1998	1999				MF-986	
MAZDA	B-4000	V6 4.0L	1998	2009			MK-8243		
MAZDA	B-4000	V6 4.0L	2000	2008				MF-4922	
MAZDA	B-4000	V6 4.0L	2001	2009		ML-2			
MAZDA	B-4000	V6 4.0L	2006	2007				MF-1036	
MAZDA	CX-3	L4 2.0L	2016	2016		ML-6607			
MAZDA	CX-5	L4 2.0L	2013	2016		ML-6607			
MAZDA	CX-5	L4 2.5L	2014	2016		ML-6607			
MAZDA	CX-7	L4 2.3L	2007	2009		ML-321			
MAZDA	CX-7	L4 2.5L	2010	2010		ML-321			
MAZDA	CX-9	L4 2.5L	2016	2016		ML-6607			
MAZDA	CX-9	V6 3.5L	2007	2007		ML-3600	MK-52045		
MAZDA	CX-9	V6 3.7L	2008	2015		ML-3600	MK-52045		
MAZDA	MAZDA 2	L4 1.5L	2011	2015		ML-6607			
MAZDA	MAZDA 3	L4 2.0L	2012	2016		ML-6607			
MAZDA	MAZDA 3	L4 2.0L VIN 8	2013	2013		ML-6607			
MAZDA	MAZDA 3	L4 2.3L	2004	2009		ML-321			



BRAND	MODEL	MOTOR	FROM	TO	HP	ACEITE	AIRE	COMBUSTIBLE	CABINA
mitsubishi	ECLIPSE	V6 3.0L FI	2000	2002		ML-3593	MK-7344		
mitsubishi	ECLIPSE	V6 3.0L FI 24 VALV.	2003	2006		ML-3593	MK-7344		
mitsubishi	ECLIPSE	V6 3.8L	2012	2012		ML-3593			
mitsubishi	ECLIPSE	V6 3.8L FI	2006	2006		ML-3593			
mitsubishi	ECLIPSE	V6 3.8L FI 24 VALV.	2010	2011		ML-3593			
mitsubishi	ECLIPSE	V6 3.8L FI 24 VALV. SOHC	2009	2009		ML-3593			
mitsubishi	ECLIPSE	V6 3.8L MFI	2008	2008		ML-3593			
mitsubishi	ECLIPSE	V6 3.8L MFI 24 VALV.	2007	2007		ML-3593			
mitsubishi	ENDEAVOR	V6 3.8L	2011	2011		ML-3593			
mitsubishi	ENDEAVOR	V6 3.8L FI 24 VALV.	2003	2010		ML-3593			
mitsubishi	ENDEAVOR	V6 3.8L FI 24 VALV.	2006	2007		ML-3593			
mitsubishi	ENDEAVOR	V6 3.8L FI 24 VALV. SOHC	2009	2009		ML-3593			
mitsubishi	ENDEAVOR	V6 3.8L MFI	2008	2008		ML-3593			
mitsubishi	GALANT	L4 2.4L	2012	2012		ML-3593			
mitsubishi	GALANT	L4 2.4L 16 VALV.	2007	2007		ML-3593			
mitsubishi	GALANT	L4 2.4L 16 VALV. SOHC	2004	2004		ML-3593			
mitsubishi	GALANT	L4 2.4L FI	1997	1998				MF-3541	
mitsubishi	GALANT	L4 2.4L FI	1997	2003		ML-3593	MK-7344		
mitsubishi	GALANT	L4 2.4L FI	2011	2011		ML-3593			
mitsubishi	GALANT	L4 2.4L FI 16 VALV.	2005	2005		ML-3593			
mitsubishi	GALANT	L4 2.4L FI 16 VALV.	2006	2010		ML-3593			
mitsubishi	GALANT	L4 2.4L MFI	2008	2009		ML-3593			
mitsubishi	GALANT	V6 2.5L FI	1997	1998		ML-3593	MK-7344		
mitsubishi	GALANT	V6 3.0L FI	1999	2002			MK-7344		
mitsubishi	GALANT	V6 3.0L FI 24 VALV.	2003	2003		ML-3593			
mitsubishi	GALANT	V6 3.0L FI 24 VALV.	2003	2006			MK-7344		
mitsubishi	GALANT	V6 3.0L FI 24 VALV.	2004	2006		ML-3593			
mitsubishi	GALANT	V6 3.8L 24 VALV.	2007	2007		ML-3593			
mitsubishi	GALANT	V6 3.8L FI 24 VALV.	2004	2006		ML-3593			
mitsubishi	GALANT	V6 3.8L FI 24 VALV.	2006	2006		ML-3593			
mitsubishi	GALANT	V6 3.8L MFI	2008	2009		ML-3593			
mitsubishi	L200	L4 2.4L	2008	2014			MK-51943		
mitsubishi	L200	L4 2.4L	2008	2015		ML-3593			
mitsubishi	L200	L4 2.5L DIESEL	2008	2014				MF-5138	
mitsubishi	L200	L4 2.5L DIESEL	2008	2016			MK-51943		
mitsubishi	L200	L4 2.5L DIESEL	2009	2015		ML-6355			
mitsubishi	L200	L4 2.5L DIESEL	2015	2015				MF-4886	
mitsubishi	LANCER	L4 2.0L	2011	2013			MK-41437		
mitsubishi	LANCER	L4 2.0L	2011	2016		ML-3593			
mitsubishi	LANCER	L4 2.0L	2012	2015		ML-3593			
mitsubishi	LANCER	L4 2.0L EFI TURBO 16 VALV.	2004	2004		ML-3593	MK-8208		
mitsubishi	LANCER	L4 2.0L FI 16 VALV.	2004	2006			MK-8208		
mitsubishi	LANCER	L4 2.0L FI 16 VALV.	2004	2010		ML-3593			
mitsubishi	LANCER	L4 2.0L FI 16 VALV.	2010	2010			MK-41437		



BRAND	MODEL	MOTOR	FROM	TO	HP	ACEITE	AIRE	COMBUSTIBLE	CABINA
MITSUBISHI	LANCER	L4 2.0L FI 16 VALV. DOHC TURBO	2009	2009		ML-3593	MK-41437		
MITSUBISHI	LANCER	L4 2.0L FI CON O SIN TURBO	2003	2003		ML-3593	MK-8208		
MITSUBISHI	LANCER	L4 2.0L FI TURBO	2007	2007		ML-6607	MK-8208		
MITSUBISHI	LANCER	L4 2.0L FI TURBO	2007	2010		ML-3593			
MITSUBISHI	LANCER	L4 2.0L FI TURBO	2008	2010			MK-41437		
MITSUBISHI	LANCER	L4 2.0L FI TURBO 16 VALV.	2006	2006		ML-3593	MK-8208		
MITSUBISHI	LANCER	L4 2.0L MFI	2008	2009		ML-3593	MK-41437		
MITSUBISHI	LANCER	L4 2.0L MFI 16 VALV.	2002	2007		ML-3593	MK-8208		
MITSUBISHI	LANCER	L4 2.0L MFI TURBO 16 VALV.	2005	2005		ML-3593	MK-8208		
MITSUBISHI	LANCER	L4 2.0L TURBO	2011	2011			MK-8208		
MITSUBISHI	LANCER	L4 2.0L TURBO	2011	2015		ML-3593			
MITSUBISHI	LANCER	L4 2.0L TURBO	2013	2014			MK-41437		
MITSUBISHI	LANCER	L4 2.0L TURBO	2014	2015		ML-3593			
MITSUBISHI	LANCER	L4 2.4L	2011	2014			MK-41437		
MITSUBISHI	LANCER	L4 2.4L	2011	2016		ML-3593			
MITSUBISHI	LANCER	L4 2.4L	2012	2015		ML-3593			
MITSUBISHI	LANCER	L4 2.4L EFI	2009	2009		ML-3593	MK-41437		
MITSUBISHI	LANCER	L4 2.4L FI	2010	2010		ML-3593	MK-41437		
MITSUBISHI	LANCER	L4 2.4L MFI 16 VALV.	2004	2007		ML-3593	MK-8208		
MITSUBISHI	LANCER	L4 2.4L MFI 16 VALV.	2006	2007		ML-6607			
MITSUBISHI	MIRAGE	3 CIL. 1.2L	2014	2015		ML-3593			
MITSUBISHI	MIRAGE	L4 1.5L FI	1997	2002			MK-8208	MF-4132	
MITSUBISHI	MIRAGE	L4 1.8L FI	1997	2002			MK-8208	MF-4132	
MITSUBISHI	MONTERO	V6 3.5L FI 24 VALV.	2003	2006		ML-3593			
MITSUBISHI	MONTERO	V6 3.8L	2015	2015		ML-3593			
MITSUBISHI	MONTERO	V6 3.8L FI	2003	2006		ML-3593			
MITSUBISHI	MONTERO SPORT	L4 2.4L	1997	1999		ML-3593	MK-7142		
MITSUBISHI	MONTERO SPORT	V6 3.0L	1997	2003		ML-3593	MK-7142		
MITSUBISHI	MONTERO SPORT	V6 3.5L	1999	1999				MF-3541	
MITSUBISHI	MONTERO SPORT	V6 3.5L	1999	2000		ML-3593			
MITSUBISHI	MONTERO SPORT	V6 3.5L	2001	2004		ML-3593			
MITSUBISHI	OUTLANDER	L4 2.0L	2010	2012		ML-3593			
MITSUBISHI	OUTLANDER	L4 2.0L	2011	2012			MK-41437		
MITSUBISHI	OUTLANDER	L4 2.0L	2013	2016		ML-3593			
MITSUBISHI	OUTLANDER	L4 2.4L	2003	2007			MK-8208		
MITSUBISHI	OUTLANDER	L4 2.4L	2003	2012		ML-3593			
MITSUBISHI	OUTLANDER	L4 2.4L	2006	2006		ML-6607			
MITSUBISHI	OUTLANDER	L4 2.4L	2008	2013			MK-41437		
MITSUBISHI	OUTLANDER	L4 2.4L	2010	2016		ML-3593			
MITSUBISHI	OUTLANDER	V6 3.0L	2007	2013			MK-41437		
MITSUBISHI	OUTLANDER	V6 3.0L	2007	2016		ML-3593			
MITSUBISHI	OUTLANDER	V6 3.0L	2010	2010		ML-6607			
MITSUBISHI	OUTLANDER	V6 3.0L	2011	2015		ML-3593			
MITSUBISHI	RAIDER	V6 3.7L FI	2006	2006		ML-3600	MK-3901		

BRAND	MODEL	MOTOR	FROM	TO	HP	ACEITE	AIRE	COMBUSTIBLE	CABINA
mitsubishi	RAIDER	V6 3.7L FI 12 VALV. SOHC	2008	2008		ML-3600			
mitsubishi	RAIDER	V6 3.7L FI 12 VALV. SOHC	2008	2009			MK-3901		
mitsubishi	RAIDER	V8 3.7L FI	2007	2007		ML-3600	MK-3901		
mitsubishi	RAIDER	V8 4.7L FI	2006	2007		ML-3614	MK-3901		
mitsubishi	RAIDER	V8 4.7L FI 16 VALV. SOHC	2009	2009		ML-2	MK-3901		
mitsubishi	RAIDER	V8 4.7L FI 16 VALV. SOHC FLEX FUEL	2010	2010		ML-2	MK-3901		
mitsubishi	RVR	L4 2.0L	2011	2011			MK-41437		
mitsubishi	RVR	L4 2.0L	2011	2015		ML-3593			
mitsubishi	SPACE STAR	L4 1.6L FI	2003	2004			MK-3901		
NISSAN	APRIO	L4 1.6L	2008	2010		ML-5796	MK-8964	MF-5857	
NISSAN	CUBE	L4 1.8L	2009	2014		ML-6607	MK-35681		
NISSAN	MARCH	L4 1.6L	2011	2011			MK-35681		
NISSAN	NV200	L4 2.0L	2013	2016		ML-6607	MK-35681		
NISSAN	PLATINA	L4 1.6L	2002	2010		ML-5796	MK-8964	MF-5857	
NISSAN	TIIDA	L4 1.6L	2013	2015			MK-35681		
NISSAN	TIIDA	L4 1.8L	2007	2015		ML-6607	MK-35681		
NISSAN	VERSA	L4 1.6L	2009	2011			MK-35681		
NISSAN	VERSA	L4 1.8L	2007	2012		ML-6607	MK-35681		
NISSAN	240SX	L4 2.4L FI 16 VALV.	1998	1998		ML-3593	MK-43080	MF-4777	
NISSAN	350Z	V6 3.5L (VQ35DE) 24 VALV.	2007	2007		ML-6607	MK-43080		
NISSAN	350Z	V6 3.5L FI	2008	2008		ML-6607			
NISSAN	350Z	V6 3.5L FI 24 VALV.	2003	2006		ML-6607	MK-43080		
NISSAN	350Z	V6 3.5L FI 24 VALV.	2005	2005		ML-3593			
NISSAN	350Z	V6 3.5L FI 24 VALV. DOHC	2009	2009		ML-6607			
NISSAN	370Z	V6 3.7L	2009	2017		ML-6607			
NISSAN	370Z HYBRID	V6 3.7L	2012	2012		ML-6607			
NISSAN	ALMERA	L4 1.8L FI 16 VALV.	2001	2005		ML-6607	MK-43080	MF-5237	
NISSAN	ALTIMA	L4 2.4L	1998	2001		ML-3593			
NISSAN	ALTIMA	L4 2.5L	2002	2004				MF-5237	
NISSAN	ALTIMA	L4 2.5L	2002	2006			MK-43080		
NISSAN	ALTIMA	L4 2.5L	2002	2008		ML-3593			
NISSAN	ALTIMA	L4 2.5L	2009	2017		ML-6607			
NISSAN	ALTIMA	V6 3.5L	2002	2004				MF-5237	
NISSAN	ALTIMA	V6 3.5L	2002	2016		ML-6607	MK-43080		
NISSAN	ALTIMA	V6 3.5L	2005	2008		ML-3593			
NISSAN	ALTIMA HYBRID	L4 2.5L DI	2010	2010		ML-6607			
NISSAN	ALTIMA HYBRID	L4 2.5L FI	2011	2011		ML-6607			
NISSAN	ALTIMA HYBRID	L4 2.5L FI 16 VALV. DOHC	2008	2008		ML-6607			
NISSAN	ALTIMA HYBRID	L4 2.5L FI 16 VALV. DOHC (QR25DE)	2007	2009		ML-6607			
NISSAN	APRIO	L4 1.6L	2011	2012			MK-9074		
NISSAN	ARMADA	V8 5.6L	2004	2015		ML-3593	MK-7440		
NISSAN	ARMADA	V8 5.6L	2010	2010		ML-6607			
NISSAN	CABSTAR	L4 2.5L (YD25DDTI) DIESEL	2008	2010		ML-16			
NISSAN	CABSTAR	L4 2.5L DIESEL	2015	2015		ML-16			

BRAND	MODEL	MOTOR	FROM	TO	HP	ACEITE	AIRE	COMBUSTIBLE	CABINA
NISSAN	D22 (FRONTIER)	L4 2.5L DIESEL (YD25)	2007	2010		ML-9432	MK-95021	MF-29882	
NISSAN	FRONTIER	L4 2.4L	2007	2007		ML-3593	MK-6850	MF-4777	
NISSAN	FRONTIER	L4 2.4L FI	1998	2005		ML-3593	MK-6850		
NISSAN	FRONTIER	L4 2.4L FI	2000	2005				MF-4777	
NISSAN	FRONTIER	L4 2.4L FI 16 VALV.	2006	2006		ML-3593	MK-6850	MF-4777	
NISSAN	FRONTIER	L4 2.5L	2007	2016		ML-6607			
NISSAN	FRONTIER	L4 2.5L FI 16 VALV. DOHC (QR25DE)	2005	2006		ML-6607			
NISSAN	FRONTIER	V6 3.3L FI	2000	2004		ML-6607	MK-43080		
NISSAN	FRONTIER	V6 3.3L FI (E)	1999	1999		ML-3593	MK-43080	MF-4777	
NISSAN	FRONTIER	V6 3.3L FI 24 VALV.	2006	2006		ML-3593	MK-43080	MF-4777	
NISSAN	FRONTIER	V6 4.0L	2007	2015			MK-7440		
NISSAN	FRONTIER	V6 4.0L	2007	2016		ML-3593		MF-4777	
NISSAN	FRONTIER	V6 4.0L	2010	2010		ML-6607			
NISSAN	FRONTIER	V6 4.0L FI	2005	2005				MF-4777	
NISSAN	FRONTIER	V6 4.0L FI	2005	2006		ML-3593	MK-7440		
NISSAN	GT-R	V6 3.8L	2009	2011		ML-6607			
NISSAN	GT-R	V6 3.8L	2012	2017		ML-3593			
NISSAN	JUKE	L4 1.6L	2011	2016		ML-6607	MK-6900		
NISSAN	LUCINO	L4 1.6L FI	2000	2000			MK-6900	MF-5237	
NISSAN	LUCINO	L4 1.6L FI (GA16)	2001	2001		ML-3593	MK-6900	MF-5237	
NISSAN	LUCINO	L4 2.0L FI	2000	2000			MK-6900	MF-5237	
NISSAN	LUCINO	L4 2.0L FI (SR20)	2001	2001		ML-3593	MK-6900	MF-5237	
NISSAN	MARCH	L4 1.6L	2011	2015		ML-6607			
NISSAN	MAXIMA	V6 3.5L	2004	2004				MF-4777	
NISSAN	MAXIMA	V6 3.5L	2004	2005		ML-3593			
NISSAN	MAXIMA	V6 3.5L	2004	2017			MK-43080		
NISSAN	MAXIMA	V6 3.5L	2006	2017		ML-6607			
NISSAN	MICRA	L4 1.4L (CR14DE) 16 VALV.	2007	2007		ML-5166	MK-5468		
NISSAN	MICRA	L4 1.4L FI	2004	2006		ML-5166	MK-5468		
NISSAN	MICRA	L4 1.4L FI (CR14DE) 16 VALV.	2008	2008		ML-5166	MK-5468		
NISSAN	MICRA	L4 1.6L CANADA	2015	2015		ML-6607			
NISSAN	MURANO	V6 3.5L	2003	2007		ML-3593			
NISSAN	MURANO	V6 3.5L	2003	2016			MK-43080		
NISSAN	MURANO	V6 3.5L	2006	2016		ML-6607			
NISSAN	NOTE	L4 1.6L	2014	2016		ML-6607			
NISSAN	NP300	L4 2.4L	2011	2013		ML-3593	MK-6850		
NISSAN	NP300	L4 2.5L DIESEL	2011	2013		ML-9432	MK-95021	MF-29882	
NISSAN	NP300	L4 2.5L DIESEL	2014	2015		ML-6607			
NISSAN	NV1500	V6 4.0L	2012	2016		ML-3593	MK-7440		
NISSAN	NV2500	V6 4.0L	2012	2016		ML-3593	MK-7440		
NISSAN	NV2500	V8 5.6L	2012	2016		ML-3593	MK-7440		
NISSAN	NV350 URVAN	L4 2.5L DIESEL	2013	2015		ML-16	MK-253		
NISSAN	NV350 URVAN	L4 2.5L GASOLINA	2013	2015		ML-3593	MK-253		
NISSAN	NV3500	V6 4.0L	2012	2016		ML-3593	MK-7440		

BRAND	MODEL	MOTOR	FROM	TO	HP	ACEITE	AIRE	COMBUSTIBLE	CABINA
NISSAN	NV3500	V8 5.6L	2012	2016		ML-3593	MK-7440		
NISSAN	PATHFINDER	V6 3.3L	1997	2000				MF-4777	
NISSAN	PATHFINDER	V6 3.5L	1997	2001		ML-3593			
NISSAN	PATHFINDER	V6 3.5L	1997	2004				MF-4777	
NISSAN	PATHFINDER	V6 3.5L	1997	2016			MK-43080		
NISSAN	PATHFINDER	V6 3.5L	2002	2016		ML-6607			
NISSAN	PATHFINDER	V6 4.0L	2005	2012		ML-3593	MK-7440		
NISSAN	PATHFINDER	V6 4.0L	2010	2010		ML-6607			
NISSAN	PATHFINDER	V8 5.6L	2004	2012		ML-3593	MK-7440		
NISSAN	PATHFINDER	V8 5.6L	2010	2010		ML-6607			
NISSAN	PATHFINDER HYBRID	L4 2.5L	2014	2015		ML-6607			
NISSAN	PICK-UP	L4 2.4L (KA24DE)	2004	2009		ML-3593	MK-6850	MF-5237	
NISSAN	PICK-UP	L4 2.4L FI	2010	2010		ML-3593	MK-6850		
NISSAN	PICK-UP	L4 2.5L DIESEL	2010	2010		ML-9432	MK-95021	MF-29882	
NISSAN	PICK-UP	L4 2.5L DIESEL (YD25)	2008	2009		ML-9432	MK-95021	MF-29882	
NISSAN	QUEST	V6 3.0L FI	1997	2003		ML-3682			
NISSAN	QUEST	V6 3.3L FI	1999	2001				MF-7404	
NISSAN	QUEST	V6 3.3L FI	1999	2005		ML-3593			
NISSAN	QUEST	V6 3.3L FI	2002	2003				MF-4777	
NISSAN	QUEST	V6 3.3L FI	2004	2006		ML-6607	MK-43080		
NISSAN	QUEST	V6 3.5L	2011	2016		ML-6607	MK-43080		
NISSAN	QUEST	V6 3.5L (VQ35) SFI 24 VALV.	2007	2007		ML-6607	MK-43080		
NISSAN	QUEST	V6 3.5L FI 24 VALV. DOHC	2009	2010		ML-6607	MK-43080		
NISSAN	QUEST	V6 3.5L SFI	2008	2008		ML-6607	MK-43080		
NISSAN	ROGUE	L4 2.5L	2008	2013			MK-6900		
NISSAN	ROGUE	L4 2.5L	2008	2016		ML-6607			
NISSAN	ROGUE SELECT	L4 2.5L	2014	2015		ML-6607	MK-6900		
NISSAN	SENTRA	L4 1.6L	2000	2000			MK-6900	MF-5237	
NISSAN	SENTRA	L4 1.8L	2001	2006		ML-3593	MK-43080	MF-5237	
NISSAN	SENTRA	L4 1.8L	2013	2016		ML-6607	MK-6900		
NISSAN	SENTRA	L4 2.0L	2001	2001				MF-5237	
NISSAN	SENTRA	L4 2.0L	2001	2011		ML-3593			
NISSAN	SENTRA	L4 2.5L	2002	2006			MK-43080		
NISSAN	SENTRA	L4 2.5L	2002	2012		ML-6607			
NISSAN	SENTRA	L4 2.5L	2003	2006				MF-5237	
NISSAN	SENTRA	L4 2.5L	2003	2011		ML-3593			
NISSAN	SENTRA	L4 2.5L	2007	2012			MK-6900		
NISSAN	TIIDA	L4 1.6L	2015	2015		ML-6607		MF-5237	
NISSAN	TITAN	V8 5.6L	2004	2015		ML-3593	MK-7440		
NISSAN	TITAN	V8 5.6L	2010	2010		ML-6607			
NISSAN	TSURU	L4 1.6L	1997	2015			MK-6900	MF-5237	
NISSAN	TSURU	L4 1.6L	2009	2015		ML-5166			
NISSAN	URVAN	L4 2.4L	2000	2001			MK-6850	MF-4777	
NISSAN	URVAN	L4 2.4L	2000	2007		ML-3593			

BRAND	MODEL	MOTOR	FROM	TO	HP	ACEITE	AIRE	COMBUSTIBLE	CABINA
NISSAN	URVAN	L4 2.4L	2002	2007			MK-253		
NISSAN	URVAN	L4 2.5L	2008	2010		ML-3593	MK-253		
NISSAN	URVAN	L4 3.0L DIESEL	2008	2011		ML-9540	MK-253	MF-29882	
NISSAN	VERSA	L4 1.6L	2009	2016		ML-6607			
NISSAN	VERSA	L4 2.5L	2008	2008		ML-6607	MK-6900		
NISSAN	X-TERRA	L4 2.4L	2000	2006		ML-3593	MK-6850	MF-4777	
NISSAN	X-TERRA	V6 3.3L	2000	2006		ML-6607	MK-43080	MF-4777	
NISSAN	X-TERRA	V6 4.0L	2005	2015		ML-3593	MK-7440		
NISSAN	X-TERRA	V6 4.0L	2010	2010		ML-6607			
NISSAN	X-TRAIL	L4 2.5L	2002	2015		ML-6607	MK-43080		
NISSAN	X-TRAIL	L4 2.5L	2008	2010		ML-3593			
NISSAN	X-TRAIL	L4 2.5L	2008	2014			MK-6900		
SEAT	ALHAMBRA	V6 2.8L	2007	2008		ML-9463		MF-5030	
SEAT	ALHAMBRA	V6 2.8L FI	2006	2006		ML-9463		MF-5030	
SEAT	ALTEA	L4 1.4L	2010	2010		ML-5548			
SEAT	ALTEA	L4 1.8L	2010	2010			MK-69754		
SEAT	ALTEA	L4 2.0L	2005	2010		ML-14120			
SEAT	CORDOBA	L4 1.6L FI	2003	2009		ML-5548	MK-9015		
SEAT	EXEO	L4 2.0L TSI	2011	2011		ML-14120	MK-25045		
SEAT	FREETRACK	L4 2.0L	2010	2015			MK-69754		
SEAT	FREETRACK	L4 2.0L	2015	2015		ML-64846			
SEAT	IBIZA	L4 1.6L	2010	2015		ML-52149			
SEAT	IBIZA	L4 1.8L	2007	2008		ML-9463	MK-9431		
SEAT	IBIZA DSG	L4 1.6L	2008	2015		ML-52149		MF-74120	
SEAT	LEON	L4 1.4L	2008	2009		ML-52149	MK-35495		
SEAT	LEON	L4 1.4L	2010	2010		ML-5548			
SEAT	LEON	L4 1.8L	2005	2007		ML-9463			
SEAT	LEON	L4 1.8L	2010	2015			MK-69754		
SEAT	LEON	L4 1.8L	2015	2015		ML-64846		MF-74120	
SEAT	LEON	L4 2.0L	2007	2015		ML-14120			
SEAT	LEON	L4 2.0L	2014	2015				MF-74120	
SEAT	TOLEDO	L4 1.6L	2014	2015				MF-74120	
SEAT	TOLEDO	L4 1.6L FI	2010	2010		ML-5552	MK-5827	MF-5870	
SEAT	TOLEDO	L4 2.0L	2006	2008		ML-14120			
SEAT	TOLEDO	L4 2.0L DI	2007	2007		ML-14120			
SEAT	ALHAMBRA	L4 1.8L	2008	2008		ML-5552		MF-5030	
SEAT	ALHAMBRA	L4 1.8L FI	2007	2007		ML-5552		MF-5030	
SEAT	ALHAMBRA	L4 1.8L FI TURBO	2004	2006		ML-5552		MF-5030	
SEAT	CORDOBA	L4 1.6L FI	2000	2002		ML-5552	MK-8995		MC-5663
SEAT	CORDOBA	L4 1.6L FI	2000	2005				MF-1051	
SEAT	CORDOBA	L4 1.6L FI	2006	2008				MF-74120	
SEAT	CORDOBA	L4 2.0L FI	2003	2005				MF-1051	
SEAT	CORDOBA	L4 2.0L FI	2003	2008					MC-9323C
SEAT	CORDOBA	L4 2.0L FI	2003	2009		ML-5552	MK-9431		

BRAND	MODEL	MOTOR	FROM	TO	HP	ACEITE	AIRE	COMBUSTIBLE	CABINA
SEAT	IBIZA	L4 1.6L	2000	2002			MK-8995		
SEAT	IBIZA	L4 1.6L	2000	2003					MC-5663
SEAT	IBIZA	L4 1.6L	2000	2005				MF-1051	
SEAT	IBIZA	L4 1.6L	2000	2008		ML-5552			
SEAT	IBIZA	L4 1.6L	2000	2009		ML-5552			
SEAT	IBIZA	L4 1.6L	2003	2009			MK-9015		
SEAT	IBIZA	L4 1.6L	2006	2015				MF-74120	
SEAT	IBIZA	L4 1.8L	2006	2008		ML-5552			MC-9323C
SEAT	IBIZA	L4 2.0L	2003	2005				MF-1051	
SEAT	IBIZA	L4 2.0L	2003	2008					MC-9323C
SEAT	IBIZA	L4 2.0L	2003	2012		ML-5552			
SEAT	IBIZA	L4 2.0L	2003	2015		ML-5552	MK-9431		
SEAT	IBIZA	L4 2.0L	2008	2015				MF-74120	
SEAT	LEON	L4 1.4L	2008	2010				MF-74120	
SEAT	LEON	L4 1.8L	2000	2005					MC-5663
SEAT	LEON	L4 1.8L	2000	2007			MK-5827		
SEAT	LEON	L4 1.8L	2000	2008		ML-5552		MF-5870	
SEAT	TOLEDO	L4 1.8L FI	2000	2000		ML-5552	MK-5827	MF-3744	MC-5663
SEAT	TOLEDO	L4 1.8L FI 20 VALV.	2003	2005		ML-5552			MC-5663
SEAT	TOLEDO	L4 1.8L FI 20 VALV.	2003	2006		ML-5552	MK-5827	MF-3744	
SEAT	TOLEDO	L4 1.8L FI 20 VALV. TURBO	2001	2002		ML-5552	MK-5827	MF-3744	MC-5663
TOYOTA	4RUNNER	L4 2.7L	2010	2011		ML-20004			
TOYOTA	4RUNNER	L4 2.7L SFI	1997	1997		ML-20004	MK-64676	MF-7196	
TOYOTA	4RUNNER	V6 3.4L EFI 24 VALV.	2001	2001		ML-20004		MF-6680	
TOYOTA	4RUNNER	V6 3.4L SFI 24 VALV.	2002	2002		ML-20004		MF-6680	
TOYOTA	4RUNNER	V6 4.0L EFI	2008	2008		ML-20004	MK-9683		
TOYOTA	4RUNNER	V6 4.0L EFI 24 VALV.	2003	2007		ML-20004	MK-9683		
TOYOTA	4RUNNER	V6 4.0L FI 24 VALV. DOHC	2009	2009		ML-20004	MK-9683		
TOYOTA	4RUNNER	V8 4.7L EFI	2008	2008		ML-20004	MK-6544		
TOYOTA	4RUNNER	V8 4.7L EFI 32 VALV.	2007	2007		ML-20004	MK-6544		
TOYOTA	4RUNNER	V8 4.7L FI 32 VALV.	2003	2006		ML-20004	MK-6544		
TOYOTA	4RUNNER	V8 4.7L FI 32 VALV. DOHC	2009	2009		ML-20004	MK-6544		
TOYOTA	CELICA	L4 1.8L FI 16 VALV. DOHC (2ZZ-GE)	2002	2002		ML-3614			
TOYOTA	FJ CRUISER	V6 4.0L	2008	2009		ML-20004			
TOYOTA	HIACE	L4 2.7L	2006	2015		ML-20004	MK-52391		
TOYOTA	HIGHLANDER	V6 3.0L	2001	2003		ML-20004	MK-20040		
TOYOTA	HIGHLANDER	V6 3.3L	2004	2007		ML-20004	MK-20040		
TOYOTA	HIGHLANDER HYBRID	V6 3.3L	2008	2010		ML-20004			
TOYOTA	HIGHLANDER HYBRID	V6 3.5L	2011	2011		ML-20004	MK-20040		
TOYOTA	HILUX	L4 2.7L	2004	2015		ML-20004			
TOYOTA	LAND CRUISER	V8 4.7L FI	2000	2003		ML-20004	MK-6544		
TOYOTA	LAND CRUISER	V8 4.7L FI 32 VALV.	2001	2006		ML-20004	MK-6544		
TOYOTA	LAND CRUISER	V8 4.7L FI DOHC	1998	1999		ML-20004	MK-6544		
TOYOTA	SEQUOIA	V8 4.7L	2001	2009		ML-20004			

BRAND	MODEL	MOTOR	FROM	TO	HP	ACEITE	AIRE	COMBUSTIBLE	CABINA
TOYOTA	SIENNA	V6 3.0L	1998	2003		ML-20004	MK-7351		
TOYOTA	SIENNA	V6 3.3L	2004	2007		ML-20004	MK-20040		
TOYOTA	SOLARA	V6 3.0L FI DOHC	1999	2003		ML-3614	MK-7351		
TOYOTA	SOLARA	V6 3.0L FI QOHC	2002	2002		ML-3614	MK-7351		
TOYOTA	SOLARA	V6 3.3L FI	2004	2006		ML-3614	MK-20040		
TOYOTA	SOLARA	V6 3.3L FI 24 VALV. DOHC	2008	2009		ML-3614	MK-20040		
TOYOTA	SOLARA	V6 3.3L SFI 24 VALV.	2007	2007		ML-3614	MK-20040		
TOYOTA	TACOMA	V6 4.0L	2005	2015		ML-20004	MK-9683		
TOYOTA	TUNDRA	V6 3.4L FI 24 VALV. DOHC (5VZ-FE)	2001	2004		ML-20004	MK-6544	MF-6680	
TOYOTA	TUNDRA	V6 3.4L FI DOHC (5VZ-FE)	1999	2000		ML-20004	MK-6544	MF-6680	
TOYOTA	TUNDRA	V6 4.0L	2007	2010		ML-20004			
TOYOTA	TUNDRA	V6 4.0L FI (1GR-FE)	2005	2006		ML-20004	MK-9683		
TOYOTA	TUNDRA	V8 4.7L	2007	2009		ML-20004			
TOYOTA	TUNDRA	V8 4.7L FI 32 VALV. DOHC (2UZ-FE)	2001	2006		ML-20004	MK-6544		
TOYOTA	TUNDRA	V8 4.7L FI DOHC (2UZ-FE)	1999	2000		ML-20004	MK-6544	MF-6680	
TOYOTA	COROLLA	L4 1.8L EFI	1998	2001		ML-4967	MK-5466		
TOYOTA	4RUNNER	V8 4.7L	2010	2010		ML-4967	MK-6544		
TOYOTA	SEQUOIA	V8 4.7L	2001	2007		ML-20004	MK-6544		
TOYOTA	AVALON	V6 3.5L	2005	2016		ML-44155			
TOYOTA	AVALON HYBRID	L4 2.5L	2013	2016		ML-44155			
TOYOTA	AVANZA	L4 1.5L	2007	2015		ML-4967			
TOYOTA	TUNDRA	V8 4.7L FI 32 VALV. DOHC (2UZ-FE)	2001	2004		ML-20004		MF-6680	
TOYOTA	CAMRY	L4 2.4L	2002	2009		ML-4967			
TOYOTA	CAMRY	L4 2.4L	2002	2006		ML-5166	MK-20040		
TOYOTA	CAMRY	L4 2.5L	2010	2016		ML-44155	MK-20040		
TOYOTA	CAMRY	V6 3.0L	2002	2006		ML-44155	MK-20040		
TOYOTA	CAMRY	V6 3.5L	2007	2011		ML-44155	MK-82393		
TOYOTA	CAMRY	V6 3.5L	2007	2016		ML-44155			
TOYOTA	CAMRY HYBRID	L4 2.4L	2007	2011		ML-4967	MK-20040		
TOYOTA	CAMRY HYBRID	L4 2.5L	2012	2016		ML-44155			
TOYOTA	CELICA	L4 1.8L FI 16 VALV. DOHC (1ZZ-FE)	2000	2005		ML-4967			
TOYOTA	CELICA	L4 1.8L FI 16 VALV. DOHC (2ZZ-GE)	2000	2004		ML-4967			
TOYOTA	CELICA	L4 1.8L FI 16 VALV. DOHC (2ZZ-GE)	2005	2005		ML-4967			
TOYOTA	COROLLA	L4 1.8L	2012	2016		ML-96796	MK-21050		
TOYOTA	COROLLA	L4 1.8L FI	2002	2002		ML-4967	MK-5466		
TOYOTA	COROLLA	L4 1.8L	2016	2016		ML-4967			
TOYOTA	MATRIX	L4 1.8L	2002	2002			MK-5466		
TOYOTA	COROLLA	L4 1.8L EFI	2009	2009		ML-96796	MK-21050		
TOYOTA	COROLLA	L4 1.8L EFI 1ZZ-FE	2005	2005		ML-4967	MK-9482		
TOYOTA	COROLLA	L4 1.8L EFI 2ZZ-GE	2005	2005		ML-4967	MK-9482		
TOYOTA	MATRIX	L4 1.8L	2003	2008			MK-9482		
TOYOTA	COROLLA	L4 1.8L FI	2002	2008		ML-4967			
TOYOTA	SOLARA	L4 2.4L FI DOHC	2003	2003				MF-3541	
TOYOTA	COROLLA	L4 1.8L FI	2011	2011		ML-96796	MK-21050		

BRAND	MODEL	MOTOR	FROM	TO	HP	ACEITE	AIRE	COMBUSTIBLE	CABINA
TOYOTA	COROLLA	L4 1.8L FI 16 VALV.	2003	2007		ML-4967	MK-9482		
TOYOTA	COROLLA	L4 1.8L FI 16 VALV. DOHC	2010	2010		ML-96796	MK-21050		
TOYOTA	COROLLA	L4 1.8L FI 1ZZ-FE	2006	2006		ML-4967	MK-9482		
TOYOTA	COROLLA	L4 1.8L FI 2ZZ-GE	2006	2006		ML-4967	MK-9482		
TOYOTA	COROLLA	L4 2.4L EFI	2009	2009		ML-4967	MK-82393		
TOYOTA	COROLLA	L4 2.4L FI	2011	2011		ML-4967	MK-82393		
TOYOTA	COROLLA	L4 2.4L FI 16 VALV. DOHC	2010	2010		ML-4967	MK-82393		
TOYOTA	ECHO	L4 1.5L EFI	2005	2005		ML-4967	MK-9115		
TOYOTA	ECHO	L4 1.5L FI	2000	2000		ML-4967	MK-9115		
TOYOTA	ECHO	L4 1.5L MFI	2001	2004		ML-4967	MK-9115		
TOYOTA	FJ CRUISER	V6 4.0L	2007	2007		ML-3600			
TOYOTA	HILUX	L4 2.7L	2004	2005				MF-75110	
TOYOTA	HIGHLANDER	L4 2.4L	2001	2007		ML-4967	MK-20040		
TOYOTA	AVALON	V6 3.5L	2005	2012			MK-82393		
TOYOTA	HIGHLANDER	L4 2.7L	2009	2016		ML-44155			
TOYOTA	HILUX	L4 2.7L	2005	2015			MK-0C010		
TOYOTA	HIGHLANDER	V6 3.5L	2008	2016		ML-44155			
TOYOTA	HIGHLANDER HYBRID	V6 3.5L	2012	2016		ML-44155			
TOYOTA	HILUX	L4 2.7L	2006	2008				MF-41570	
TOYOTA	RAV 4	L4 2.4L	2006	2008			MK-82393		
TOYOTA	CAMRY	L4 2.4L	2007	2009		ML-44155	MK-20040		
TOYOTA	LAND CRUISER	V8 4.7L EFI 32 VALV.	2007	2007		ML-3600	MK-6544		
TOYOTA	LAND CRUISER	V8 5.7L	2008	2016		ML-12027			
TOYOTA	FJ CRUISER	V6 4.0L	2007	2010			MK-9683		
TOYOTA	MATRIX	L4 1.8L	2002	2008		ML-4967			
TOYOTA	SIENNA	V6 3.5L	2007	2010			MK-20040		
TOYOTA	MATRIX	L4 1.8L	2008	2014		ML-96796			
TOYOTA	TUNDRA	V6 4.0L	2007	2014			MK-9683		
TOYOTA	MATRIX	L4 2.4L	2009	2013		ML-4967	MK-82393		
TOYOTA	MATRIX HYBRID	L4 1.8L FI 16 VALV. DOHC	2008	2008		ML-96796	MK-9482		
TOYOTA	MR2 SPYDER	L4 1.8L FI	2000	2004		ML-4967			
TOYOTA	MR2 SPYDER	L4 1.8L FI 16 VALV.	2005	2005		ML-4967			
TOYOTA	PRIUS HYBRID	L4 1.5L	2001	2016		ML-4967			
TOYOTA	PRIUS HYBRID	L4 1.8L	2010	2016		ML-96796			
TOYOTA	RAV 4	L4 2.4L	2004	2008		ML-4967			
TOYOTA	COROLLA	L4 1.8L FI	2008	2008			MK-9482		
TOYOTA	HIGHLANDER	V6 3.5L	2008	2013			MK-20040		
TOYOTA	RAV 4	L4 2.5L	2009	2016		ML-44155			
TOYOTA	RAV 4	V6 3.5L	2006	2012		ML-44155	MK-82393		
TOYOTA	RAV 4 HYBRID	L4 2.5L	2016	2016		ML-44155			
TOYOTA	SEQUOIA	V8 4.6L	2010	2012		ML-12027			
TOYOTA	HIGHLANDER	L4 2.7L	2009	2013			MK-20040		
TOYOTA	SEQUOIA	V8 5.7L	2008	2016		ML-12027			
TOYOTA	SIENNA	L4 2.7L	2011	2013		ML-44155			



BRAND	MODEL	MOTOR	FROM	TO	HP	ACEITE	AIRE	COMBUSTIBLE	CABINA
TOYOTA	MATRIX	L4 1.8L	2009	2014			MK-21050		
TOYOTA	SIENNA	V6 3.5L	2007	2016		ML-44155			
TOYOTA	SOLARA	L4 2.2L FI DOHC	1999	2001		ML-4967	MK-7351	MF-3541	
TOYOTA	SOLARA	L4 2.4L FI 16 VALV. DOHC	2004	2009		ML-4967	MK-20040		
TOYOTA	SOLARA	L4 2.4L FI DOHC	2002	2003		ML-4967	MK-7351		
TOYOTA	RAV 4	L4 2.5L	2009	2012			MK-82393		
TOYOTA	TACOMA	V6 3.5L	2016	2016		ML-44155	MK-9683		
TOYOTA	TACOMA	V6 4.0L	2006	2006		ML-3600			
TOYOTA	TACOMA	V8 4.7L	2005	2005		ML-3600	MK-9683		
TOYOTA	4RUNNER	V6 4.0L	2011	2012			MK-9683		
TOYOTA	TUNDRA	V8 4.6L	2010	2016		ML-12027			
TOYOTA	COROLLA	L4 1.8L	2014	2016			MK-82393		
TOYOTA	TUNDRA	V8 5.7L	2007	2016		ML-12027			
TOYOTA	TUNDRA	V8 5.7L FLEX FUEL	2010	2011		ML-12027			
TOYOTA	VENZA	L4 2.7L	2009	2016		ML-44155	MK-20040		
TOYOTA	VENZA	V6 3.5	2016	2016		ML-44155	MK-82393		
TOYOTA	VENZA	V6 3.5L	2009	2015		ML-44155	MK-82393		
TOYOTA	YARIS	L4 1.3L	2003	2005		ML-4967	MK-9115		
TOYOTA	YARIS	L4 1.5L	2006	2016		ML-4967	MK-21050		
VOLKSWAGEN	BEETLE	5 CIL. 2.5L	2006	2015		ML-14120		MF-5870	
VOLKSWAGEN	BEETLE	5 CIL. 2.5L	2012	2014		ML-3614			
VOLKSWAGEN	PASSAT	5 CIL. 2.5L	2012	2014		ML-3614			
VOLKSWAGEN	PASSAT	V6 3.6L	2012	2016				MF-52021	
VOLKSWAGEN	TIGUAN	L4 1.4L	2015	2015				MF-52021	
VOLKSWAGEN	GOLF	L4 2.0L DIESEL	2014	2014				MF-52021	
VOLKSWAGEN	JETTA	L4 2.0L DIESEL	2013	2014				MF-52021	
VOLKSWAGEN	BEETLE	L4 2.0L	2016	2016				MF-74120	
VOLKSWAGEN	BEETLE	L4 2.0L TURBO	2014	2014		ML-64846	MK-69754	MF-74120	
VOLKSWAGEN	JETTA	L4 2.0L	2012	2015				MF-74120	
VOLKSWAGEN	JETTA	L4 2.0L TURBO	2014	2014				MF-74120	
VOLKSWAGEN	BORA	L4 1.9L DIESEL	2006	2010		ML-9463	MK-69754	MF-52021	
VOLKSWAGEN	BORA	L4 2.0L	2006	2010		ML-14120	MK-35495		
VOLKSWAGEN	BORA	L5 2.5L	2006	2010		ML-14120			
VOLKSWAGEN	JETTA HYBRID	L4 1.4L	2014	2014				MF-74120	
VOLKSWAGEN	CC	L4 1.8L	2009	2009			MK-69754		
VOLKSWAGEN	CC	L4 2.0L	2009	2016		ML-64846	MK-69754		
VOLKSWAGEN	CC	V6 3.6L	2009	2012		ML-9463			
VOLKSWAGEN	CROSSFOX	L4 1.6L	2007	2015		ML-5548	MK-9015	MF-5738	
VOLKSWAGEN	EOS	L4 2.0L	2007	2008		ML-14120		MF-74120	
VOLKSWAGEN	EOS	L4 2.0L	2010	2016		ML-64846	MK-69754		
VOLKSWAGEN	EOS	L4 2.0L BPY	2009	2009		ML-14120			
VOLKSWAGEN	EOS	L4 2.0L CBFA	2009	2009		ML-64846	MK-69754		
VOLKSWAGEN	EOS	L4 2.0L DIESEL	2007	2008		ML-14120			
VOLKSWAGEN	EOS	V6 3.2L	2007	2008		ML-9463	MK-5827	MF-74120	

BRAND	MODEL	MOTOR	FROM	TO	HP	ACEITE	AIRE	COMBUSTIBLE	CABINA
VOLKSWAGEN	EUROVAN	L4 1.9L TDI DIESEL	2006	2010		ML-9463			
VOLKSWAGEN	EUROVAN	V6 2.8L FI	2000	2002		ML-3614		MF-5030	
VOLKSWAGEN	GLI	5 CIL. 2.5L DI 20 VALV.	2007	2007		ML-14120			
VOLKSWAGEN	GLI	L4 2.0L	2011	2011			MK-69754		
VOLKSWAGEN	GLI	L4 2.0L DI 16 VALV. DOHC TURBO	2007	2008		ML-14120			
VOLKSWAGEN	GLI	L4 2.0L DI TURBO	2010	2010			MK-69754		
VOLKSWAGEN	GOL	L4 1.6L	2009	2015		ML-5548	MK15728	MF-5857	
VOLKSWAGEN	GOLF	5 CIL. 2.5L	2010	2014		ML-14120		MF-74120	
VOLKSWAGEN	GOLF	5 CIL. 2.5L FI 20 VALV. DOHC	2006	2007		ML-14120			
VOLKSWAGEN	PASSAT	5 CIL. 2.5L	2014	2014				MF-74120	
VOLKSWAGEN	GOLF	L4 1.9L DIESEL TURBO	2006	2007		ML-9463	MK-5827		
VOLKSWAGEN	GOLF	L4 2.0L	2011	2011			MK-69754		
VOLKSWAGEN	TOUAREG HYBRID	V6 3.0L	2012	2016				MF-74120	
VOLKSWAGEN	GOLF	L4 2.0L DI 16 VALV. DOHC TURBO	2006	2007		ML-14120			
VOLKSWAGEN	GOLF	L4 2.0L DIESEL	2010	2014		ML-9463	MK-69754		
VOLKSWAGEN	VENTO	L4 1.6L	2014	2015				MF-74120	
VOLKSWAGEN	GOLF	V6 2.8L FI	1997	1999		ML-3614			
VOLKSWAGEN	GOLF	V6 2.8L SFI	2003	2005		ML-9463			
VOLKSWAGEN	GOLF	V6 3.2L	2010	2010		ML-9463		MF-52021	
VOLKSWAGEN	GTI	5 CIL. 2.5L	2006	2007		ML-14120			
VOLKSWAGEN	GTI	L4 1.9L DIESEL	2006	2007		ML-9463	MK-5827		
VOLKSWAGEN	GTI	L4 2.0L	2007	2009		ML-14120			
VOLKSWAGEN	GTI	L4 2.0L	2009	2014			MK-69754		
VOLKSWAGEN	GTI	L4 2.0L DI 16 VALV. DOHC TURBO	2006	2006		ML-14120			
VOLKSWAGEN	JETTA	5 CIL. 2.5L	2009	2015		ML-14120			
VOLKSWAGEN	JETTA	5 CIL. 2.5L DI	2010	2010		ML-14120		MF-74120	
VOLKSWAGEN	JETTA	5 CIL. 2.5L DI 20 VALV.	2007	2007		ML-14120		MF-74120	
VOLKSWAGEN	JETTA	5 CIL. 2.5L DI 20 VALV. DOHC	2008	2008		ML-14120		MF-74120	
VOLKSWAGEN	JETTA	5 CIL. 2.5L FI 20 VALV. DOHC	2005	2006		ML-14120			
VOLKSWAGEN	CADDY	L4 1.2L	2015	2015			MK-35495		
VOLKSWAGEN	BEETLE	L4 1.8L	2015	2016			MK-69754		
VOLKSWAGEN	JETTA	L4 1.9L DIESEL	2006	2006		ML-9463		MF-52021	
VOLKSWAGEN	JETTA	L4 1.9L TDI DIESEL	2007	2007		ML-9463	MK-5827		
VOLKSWAGEN	JETTA	L4 2.0L	2011	2015		ML-5552	MK-35495		
VOLKSWAGEN	BEETLE	L4 1.8L TURBO	2014	2014			MK-69754		
VOLKSWAGEN	BEETLE	L4 2.0L	2012	2016			MK-69754		
VOLKSWAGEN	JETTA	L4 2.0L DI 16 VALV. DOHC TURBO	2006	2008		ML-14120			
VOLKSWAGEN	JETTA	L4 2.0L DI DIESEL TURBO	2009	2009		ML-9463	MK-69754		
VOLKSWAGEN	JETTA	L4 2.0L DI TURBO	2010	2010		ML-14120	MK-69754		
VOLKSWAGEN	JETTA	L4 2.0L DI TURBO DIESEL	2010	2010		ML-9463	MK-69754		
VOLKSWAGEN	JETTA	L4 2.0L DIESEL	2011	2014		ML-9463			
VOLKSWAGEN	JETTA	L4 2.0L DIESEL	2011	2016			MK-69754		
VOLKSWAGEN	BEETLE	L4 2.0L DIESEL	2013	2015			MK-69754		
VOLKSWAGEN	JETTA	L4 2.0L DIESEL TURBO	2008	2008		ML-9463		MF-52021	

BRAND	MODEL	MOTOR	FROM	TO	HP	ACEITE	AIRE	COMBUSTIBLE	CABINA
VOLKSWAGEN	JETTA	L4 2.0L TURBO	2011	2015			MK-69754		
VOLKSWAGEN	JETTA	L4 1.8L	2015	2016			MK-69754		
VOLKSWAGEN	JETTA	L4 1.8L TURBO	2014	2014			MK-69754		
VOLKSWAGEN	JETTA	L4 2.0L	2016	2016			MK-69754		
VOLKSWAGEN	PASSAT	L4 1.8L	2014	2016			MK-69754		
VOLKSWAGEN	LUPO	L4 1.6L FI	2005	2009		ML-5548	MK-9015	MF-5738	
VOLKSWAGEN	PASSAT	L4 2.0L DIESEL	2012	2014			MK-69754		
VOLKSWAGEN	GOLF	L4 2.0L	2012	2013		ML-14120			
VOLKSWAGEN	PASSAT	5 CIL. 2.5L	2012	2015		ML-14120			
VOLKSWAGEN	JETTA HYBRID	L4 1.4L	2013	2013		ML-3614			
VOLKSWAGEN	PASSAT	L4 1.9L FSI TURBO 16 VALV.	2006	2007		ML-14120			
VOLKSWAGEN	PASSAT	L4 2.0L DI 16 VALV. DOHC BPY TURBO	2009	2009		ML-14120			
VOLKSWAGEN	PASSAT	L4 2.0L DI 16 VALV. DOHC CCTA TURBO	2009	2009		ML-64846	MK-69754		
VOLKSWAGEN	PASSAT	L4 2.0L DI 16 VALV. DOHC TURBO	2006	2007		ML-14120			
VOLKSWAGEN	PASSAT	L4 2.0L DI TURBO	2008	2008		ML-14120			
VOLKSWAGEN	PASSAT	L4 2.0L DI TURBO	2010	2010			MK-69754		
VOLKSWAGEN	BEETLE	L4 2.0L	2012	2013		ML-64846			
VOLKSWAGEN	PASSAT	L4 2.0L FI TURBO	2011	2011			MK-69754		
VOLKSWAGEN	PASSAT	V6 2.8L FI 30 VALV.	1999	2002		ML-3614			
VOLKSWAGEN	PASSAT	V6 3.6L DI	2008	2008		ML-9463		MF-52021	
VOLKSWAGEN	PASSAT	V6 3.6L FI 24 VALV.	2010	2010		ML-9463		MF-52021	
VOLKSWAGEN	PASSAT	V6 3.6L FSI 24 VALV.	2006	2007		ML-9463		MF-52021	
VOLKSWAGEN	PASSAT	W8 4.0L FI	2002	2005		ML-3614	MK-5107		
VOLKSWAGEN	POLO	L4 1.6L	2003	2007		ML-5548	MK-9015	MF-5870	
VOLKSWAGEN	R32	V6 3.2L FI 24 VALV.	2007	2007		ML-9463	MK-5827		
VOLKSWAGEN	R32	V6 3.2L FI 24 VALV. DOHC	2008	2008		ML-9463		MF-52021	
VOLKSWAGEN	RABBIT	5 CIL. 2.5L FI 20 VALV. DOHC	2007	2010		ML-14120			
VOLKSWAGEN	RABBIT	L4 2.0L DI 16 VALV. DOHC BPY TURBO	2009	2009		ML-14120			
VOLKSWAGEN	RABBIT	L4 2.0L DI 16 VALV. DOHC CBFA TURBO	2009	2009			MK-69754		
VOLKSWAGEN	RABBIT	L4 2.0L DI 16 VALV. DOHC CCTA TURBO	2009	2009			MK-69754		
VOLKSWAGEN	RABBIT	L4 2.0L DI 16 VALV. DOHC TURBO	2007	2007		ML-14120			
VOLKSWAGEN	RABBIT	V6 3.2L DI 24 VALV. DOHC	2009	2009		ML-9463		MF-52021	
VOLKSWAGEN	ROUTAN	V6 3.6L	2011	2014		ML-3614			
VOLKSWAGEN	ROUTAN	V6 3.8L	2009	2010		ML-3614			
VOLKSWAGEN	ROUTAN	V6 4.0L	2009	2010		ML-10060			
VOLKSWAGEN	SAVEIRO	L4 1.6L	2010	2015		ML-5548	MK15728	MF-5857	
VOLKSWAGEN	SPORT VAN	L4 1.6L FI	2008	2010		ML-5548	MK-9015	MF-74120	
VOLKSWAGEN	SPORT VAN	L4 1.6L MPFI	2007	2007		ML-5548	MK-9015	MF-74120	
VOLKSWAGEN	JETTA	L4 2.0L TURBO	2012	2014		ML-64846			
VOLKSWAGEN	TIGUAN	L4 2.0L	2008	2008		ML-9463			
VOLKSWAGEN	TIGUAN	L4 2.0L	2008	2016			MK-69754		
VOLKSWAGEN	TOUAREG	V6 3.2L	2004	2007		ML-3614			
VOLKSWAGEN	TOUAREG	V6 3.6L	2007	2011		ML-3614			
VOLKSWAGEN	TOUAREG	V8 4.2L	2004	2006		ML-3614			

BRAND	MODEL	MOTOR	FROM	TO	HP	ACEITE	AIRE	COMBUSTIBLE	CABINA
VOLKSWAGEN	BEETLE	L4 2.0L DIESEL	2013	2014		ML-9463			
VOLKSWAGEN	GOLF	L4 1.4L	2015	2015		ML-9463			
VOLKSWAGEN	TRANSPORTER	L4 2.0L DIESEL	2011	2011		ML-9463			
VOLKSWAGEN	TRANSPORTER	L4 2.0L DIESEL	2011	2015		ML-3614			
VOLKSWAGEN	PASSAT	L4 2.0L DIESEL	2012	2012		ML-9463			
VOLKSWAGEN	BEETLE	5 CIL. 2.5L	2006	2011			MK-5827		
VOLKSWAGEN	BEETLE	5 CIL. 2.5L	2006	2012					MC-5663
VOLKSWAGEN	BEETLE	L4 1.8L	1999	2005		ML-5552	MK-5827	MF-5870	MC-5663
VOLKSWAGEN	BEETLE	L4 1.9L DIESEL	1998	2009			MK-5827		MC-5663
VOLKSWAGEN	BEETLE	L4 2.0L	1998	2005					MC-5663
VOLKSWAGEN	BEETLE	L4 2.0L	1998	2011		ML-5552	MK-5827	MF-5870	
VOLKSWAGEN	BEETLE	L4 2.0L	2007	2008			MK-9015		
VOLKSWAGEN	CABRIO	L4 1.8L	2003	2003			MK-7431	MF-5030	
VOLKSWAGEN	CABRIO	L4 1.8L	2003	2005		ML-5552			
VOLKSWAGEN	CABRIO	L4 1.8L	2004	2005			MK-5827	MF-5870	
VOLKSWAGEN	CABRIO	L4 1.9L DIESEL	2004	2006			MK-5827		
VOLKSWAGEN	CABRIO	L4 2.0L	2003	2005				MF-5870	
VOLKSWAGEN	CABRIO	L4 2.0L	2004	2005			MK-5827		
VOLKSWAGEN	CABRIO	L5 2.5L	2006	2007			MK-5827	MF-5870	
VOLKSWAGEN	CC	V6 3.6L	2009	2016				MF-52021	
VOLKSWAGEN	CLASICO	L4 2.0L	2011	2012			MK-5827		
VOLKSWAGEN	CLASICO	L4 2.0L	2011	2015		ML-5552		MF-5870	
VOLKSWAGEN	CRAFTER	L5 2.5L DIESEL	2008	2015			MK-93235		
VOLKSWAGEN	CROSSFOX	L4 1.6L	2007	2009					MC-9323C
VOLKSWAGEN	DERBY	L4 1.8L FI	1999	2009				MF-618	
VOLKSWAGEN	DERBY	L4 1.8L FI	2000	2009			MK-8995		
VOLKSWAGEN	DERBY	L4 2.0L FI	2002	2004			MK-5377		
VOLKSWAGEN	DERBY	L4 2.0L FI	2002	2005		ML-5552		MF-618	MC-5663
VOLKSWAGEN	EOS	L4 2.0L CCTA	2009	2009		ML-64846			
VOLKSWAGEN	EUROVAN	L5 2.5L FI	2001	2005		ML-88227		MF-5030	
VOLKSWAGEN	GLI	L4 2.0L DI 16 VALV. DOHC TURBO	2009	2009				MF-52021	
VOLKSWAGEN	GOLF	L4 1.8L	2010	2010		ML-5552	MK-5827		
VOLKSWAGEN	GOLF	L4 1.8L FI	2004	2004		ML-5552		MF-5870	
VOLKSWAGEN	GOLF	L4 1.8L FI	2004	2009			MK-5827		
VOLKSWAGEN	GOLF	L4 1.8L FI 20 VALV. DOHC TURBO	2006	2006		ML-5552	MK-5827	MF-5870	MC-5663
VOLKSWAGEN	GOLF	L4 1.8L FI TURBO	2000	2003		ML-5552	MK-5827	MF-5870	MC-5663
VOLKSWAGEN	GOLF	L4 1.8L SFI TURBO	2005	2005		ML-5552	MK-5827	MF-5870	MC-5663
VOLKSWAGEN	GOLF	L4 1.9L FI TURBO DIESEL	2000	2004			MK-5827		MC-5663
VOLKSWAGEN	GOLF	L4 1.9L FI TURBO DIESEL CANADA	1998	1998		ML-88227	MK-7431		
VOLKSWAGEN	GOLF	L4 2.0L	2010	2010		ML-5552	MK-5827		
VOLKSWAGEN	GOLF	L4 2.0L FI	2000	2003				MF-5870	
VOLKSWAGEN	GOLF	L4 2.0L FI	2000	2009			MK-5827		
VOLKSWAGEN	GOLF	L4 2.0L FI 8 VALV. SOHC AVH	2006	2006		ML-5552	MK-5827	MF-5870	MC-5663
VOLKSWAGEN	GOLF	L4 2.0L FI 8 VALV. SOHC BEV	2006	2006		ML-5552			MC-5663

BRAND	MODEL	MOTOR	FROM	TO	HP	ACEITE	AIRE	COMBUSTIBLE	CABINA
VOLKSWAGEN	GOLF	L4 2.0L FI TURBO	2004	2005		ML-5552	MK-5827	MF-5870	MC-5663
VOLKSWAGEN	GOLF	V6 2.8L FI	1997	1998			MK-5301	MF-3747	
VOLKSWAGEN	GOLF	V6 2.8L SFI	2000	2005				MF-5870	
VOLKSWAGEN	GOLF	V6 2.8L SFI	2001	2005			MK-5827		
VOLKSWAGEN	GTI	L4 1.8L	2006	2006		ML-5552	MK-5827	MF-5870	MC-5663
VOLKSWAGEN	GTI	L4 2.0L	2008	2014		ML-64846			
VOLKSWAGEN	GTI	L4 2.0L FI 8 VALV. SOHC AVH	2006	2006		ML-5552	MK-5827	MF-5870	MC-5663
VOLKSWAGEN	GTI	L4 2.0L FI 8 VALV. SOHC BEV	2006	2006		ML-5552			
VOLKSWAGEN	JETTA	5 CIL. 2.5L	2009	2014		ML-3614		MF-74120	
VOLKSWAGEN	JETTA	5 CIL. 2.5L FI 20 VALV. DOHC	2005	2005				MF-74120	
VOLKSWAGEN	JETTA	L4 1.8L FI TURBO	2000	2004		ML-5552			
VOLKSWAGEN	JETTA	L4 1.8L FI TURBO	2000	2005		ML-5552	MK-5827	MF-5870	MC-5663
VOLKSWAGEN	JETTA	L4 1.9L DI TURBO DIESEL	2001	2004			MK-5827		MC-5663
VOLKSWAGEN	JETTA	L4 1.9L DIESEL	1997	1997		ML-88227	MK-7431		
VOLKSWAGEN	JETTA	L4 1.9L DIESEL	1997	2005					MC-5663
VOLKSWAGEN	JETTA	L4 1.9L DIESEL	2005	2006			MK-5827		
VOLKSWAGEN	JETTA	L4 1.9L FI	2010	2010		ML-5552		MF-5870	
VOLKSWAGEN	JETTA	L4 1.9L TURBO DIESEL	1999	1999			MK-7431		
VOLKSWAGEN	JETTA	L4 1.9L TURBO DIESEL	1999	2003					MC-5663
VOLKSWAGEN	JETTA	L4 1.9L TURBO DIESEL	2000	2003			MK-5827		
VOLKSWAGEN	JETTA	L4 2.0L DI 16 VALV. DOHC TURBO	2006	2006				MF-74120	
VOLKSWAGEN	JETTA	L4 2.0L DI 16 VALV. DOHC TURBO	2006	2009		ML-64846			
VOLKSWAGEN	JETTA	L4 2.0L DI 16 VALV. DOHC TURBO	2009	2009				MF-52021	
VOLKSWAGEN	JETTA	L4 2.0L EFI	2007	2007		ML-5552	MK-5827	MF-5870	
VOLKSWAGEN	JETTA	L4 2.0L FI	2000	2009			MK-5827	MF-5870	
VOLKSWAGEN	JETTA	V6 2.8L FI	2000	2004			MK-5827	MF-5870	
VOLKSWAGEN	LUPO	L4 1.6L FI	2005	2007					MC-5663
VOLKSWAGEN	PASSAT	L4 1.8L FI 20 VALV. TURBO	1999	2003		ML-88227			
VOLKSWAGEN	PASSAT	L4 1.8L FI 20 VALV. TURBO	1999	2005			MK-5107	MF-5030	
VOLKSWAGEN	PASSAT	L4 1.8L FI 20 VALV. TURBO	2002	2005					MC-5663
VOLKSWAGEN	PASSAT	L4 1.8L FI 20 VALV. TURBO	2004	2005		ML-5552			
VOLKSWAGEN	PASSAT	L4 1.8L MFI TURBO	1998	1998		ML-88227	MK-5107	MF-5030	
VOLKSWAGEN	PASSAT	L4 1.9L DIESEL	1997	1997		ML-88227	MK-5301		
VOLKSWAGEN	PASSAT	L4 2.0L DI TURBO	2008	2010		ML-64846			
VOLKSWAGEN	PASSAT	L4 2.0L FI TURBO DIESEL	2004	2005			MK-5107		MC-5663
VOLKSWAGEN	PASSAT	V6 2.8L FI	1997	1998			MK-5301		
VOLKSWAGEN	PASSAT	V6 2.8L FI 30 VALV.	1999	2005			MK-5107	MF-5030	
VOLKSWAGEN	PASSAT	V6 2.8L FI 30 VALV.	2002	2005					MC-5663
VOLKSWAGEN	PASSAT	V6 2.8L FI 30 VALV.	2003	2004				MF-3747	
VOLKSWAGEN	PASSAT	V6 2.8L FI 30 VALV.	2003	2005		ML-16			
VOLKSWAGEN	PASSAT	W8 4.0L FI	2002	2004				MF-3747	MC-5663
VOLKSWAGEN	PASSAT	W8 4.0L FI	2005	2005				MF-3747	
VOLKSWAGEN	POINTER	L4 1.8L FI	1998	1998				MF-5030	
VOLKSWAGEN	POINTER	L4 1.8L FI	1998	2009		ML-5552	MK-5377		

BRAND	MODEL	MOTOR	FROM	TO	HP	ACEITE	AIRE	COMBUSTIBLE	CABINA
VOLKSWAGEN	POINTER	L4 1.8L FI	1999	2009				MF-5738	
VOLKSWAGEN	POINTER	L4 2.0L FI	2000	2007		ML-5552	MK-5377	MF-5738	
VOLKSWAGEN	POINTER PICK-UP	L4 1.8L FI	1999	2010		ML-5552	MK-5377	MF-5738	
VOLKSWAGEN	POLO	L4 1.6L	2003	2015				MF-74120	
VOLKSWAGEN	POLO	L4 2.0L	2003	2007		ML-5552	MK-9431	MF-5870	
VOLKSWAGEN	R32	V6 3.2L FI 24 VALV. DOHC	2004	2005			MK-5827	MF-5870	MC-5663
VOLKSWAGEN	RABBIT	5 CIL. 2.5L FI 20 VALV. DOHC	2007	2009				MF-74120	
VOLKSWAGEN	SHARAN	L4 1.8L FI TURBO	2002	2008		ML-5552		MF-5030	
VOLKSWAGEN	SHARAN	L4 1.8L TURBO	2007	2007		ML-5552		MF-5030	
VOLKSWAGEN	TIGUAN	L4 2.0L	2009	2016		ML-64846			
VOLKSWAGEN	VAN	L4 1.8L FI	2002	2008		ML-5552		MF-618	MC-5663





## FILTROS DE CABINA

La calidad del aire en el habitáculo es garantizada por los filtros Millard® a través de la más moderna tecnología de geometría de plisado en los elementos filtrantes y en su encaje fácil, cierto y preciso, evitando de esta forma los reflujos del aire no filtrados.

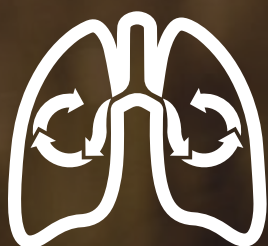

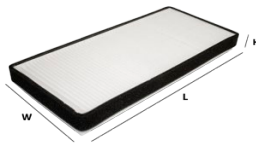

<b>MC-12021</b>	CROSS REFERENCES	BRAND	MODEL	ENGINE	KW		
 <p> <b>H</b> = 32 mm  <b>L</b> = 348 mm  <b>W</b> = 155 mm         </p>	FORD	96FW16N619AB	FORD	COURIER			
	FORD	A92FX9601CA	FORD	E SERIES (VANS)			
	MAZDA	1E0061J6X	FORD	EXPEDITION			
	MAZDA	1E0061J6XB	FORD	F SERIES			
	MAZDA	1E0061J6XC	FORD	F SERIES SUPER DUTY			
	MAZDA	1E0061J6XD	FORD	KA			
	MAZDA	410077732					
	FRAM	CF5817					
	INTERFIL	CFI96FW					
	INTERFIL	CFI96FWCA					

<b>MC-16462</b>	CROSS REFERENCES	BRAND	MODEL	ENGINE	KW		
 <p> <b>H</b> = 34 mm  <b>L</b> = 241 mm  <b>W</b> = 189 mm         </p>	FORD	1585216	FORD	FIESTA HATCHBACK			
	FORD	2S6H16N619AA					
	FRAM	CF9666					
	INTERFIL	CFI2S6H					
	INTERFIL	CFI2S6HCA					

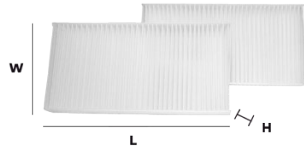
<b>MC-35422</b>	CROSS REFERENCES	BRAND	MODEL	ENGINE	KW		
 <p> <b>H</b> = 28 mm  <b>L</b> = 225 mm  <b>W</b> = 111 mm         </p>	HONDA	08292SCAE11	HONDA	ACCORD			
	HONDA	08R79S5A600	HONDA	CIVIC			
	HONDA	80292S50A01	HONDA	CIVIC HYBRID			
	HONDA	80292S6DG01	HONDA	CR-V			
	HONDA	80292S6M901	HONDA	ELEMENT			
	HONDA	80292SCAE11					
	FRAM	CF9819					
	FRAM	CF98192					
	INTERFIL	CFI2S5A					
	INTERFIL	CFI2S5ACA					

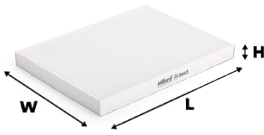
<b>MC-5663</b>	CROSS REFERENCES	BRAND	MODEL	ENGINE	KW		
 <p> <b>H</b> = 25 mm  <b>L</b> = 282 mm  <b>W</b> = 205 mm         </p>	VW GROUP	1HO 819 638	AUDI				
	VW GROUP	1HO 819 638A	SEAT				
	VW GROUP	1HO 819 644	VOLKSWAGEN				
	FRAM	CA5663					
	FRAM	CF5474					
	FRAM	CF5663					
	FRAM	CF8644					
	FRAM	CF8893					
	INTERFIL	CFI1H08					
	INTERFIL	CFI1H08CA					

## MC-67836C

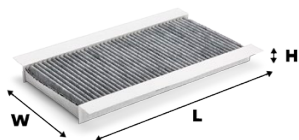

H = 30 mm

L = 345 mm

W = 163 mm

CROSS REFERENCES		BRAND	MODEL	ENGINE	KW		
FORD	1382861	FORD	ESCORT				
FORD	1585195	FORD	FOCUS				
FORD	1672948						
FORD	XS4H16N619AB						
FORD	XS4H19G244BA						
FORD	XS4H19G244CA						
FRAM	CF8831						
FRAM	CFA8831						
INTERFIL	CFIXS4H						
INTERFIL	CFIXS4HCA						

## MC-9323C

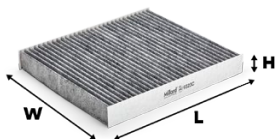

H = 32 mm

L = 248 mm

W = 216 mm

CROSS REFERENCES		BRAND	MODEL	ENGINE	KW		
VW GROUP	6Q0 819 653	SEAT	CORDOBA				
VW GROUP	6Q0 819 653B	SEAT	IBIZA				
VW GROUP	6Q0 820 367	SEAT	LEON				
VW GROUP	6Q0 820 367A	VOLKSWAGEN	CROSSFOX				
VW GROUP	6R0 820 367						
VW GROUP	JZW 819 653A						
FRAM	CF9323						
FRAM	CFA9404						
INTERFIL	CFI6Q08						
INTERFIL	CFI6Q08CA						





## FILTROS DE AIRE

El aire es el fluido más importante ya que es el responsable por el desempeño de los demás fluidos, de él depende el buen funcionamiento de los motores a combustión. La tecnología de plisado Millard® permite un aumento considerable del área filtrante, la cual es resistente a la humedad y a altas presiones. Los filtros del aire Millard® representan el equilibrio perfecto entre naturaleza y tecnología.

<b>MK-0C010</b>		CROSS REFERENCES	BRAND	MODEL	ENGINE	KW	
<p> <b>H</b> = 174 mm  <b>OD</b> = 220 mm  <b>ID1</b> = 120 mm         </p>	TOYOTA	17801-0C010	TOYOTA	HILUX			
	TOYOTA	17801-0C010-00					
	TOYOTA	17801-0C020					
	TOYOTA	17801-0C030					
	FRAM	CA10112					
	FRAM	CA9916					
	INTERFIL	F17A80					

<b>MK-10118</b>		CROSS REFERENCES	BRAND	MODEL	ENGINE	KW	
<p> <b>H</b> = 31 mm  <b>L</b> = 328 mm  <b>W</b> = 168 mm         </p>	CHRYSLER	04891694AA	DODGE	CALIBER			
	CHRYSLER	104891695AA	JEEP	COMPASS			
	CHRYSLER	4891694AA	JEEP	PATRIOT			
	DODGE	04891694AA					
	DODGE	4891695AA					
	FIAT	K04891695AA					
	FRAM	CA10118					
	FRAM	CA10622					
INTERFIL	F16A94						

<b>MK-14641</b>		CROSS REFERENCES	BRAND	MODEL	ENGINE	KW	
<p> <b>H</b> = 40 mm  <b>L</b> = 266 mm  <b>W</b> = 259 mm         </p>	GM	13272719	CHEVROLET	CRUZE			
	FRAM	CA10880	CHEVROLET	ORLANDO			

<b>MK-15728</b>		CROSS REFERENCES	BRAND	MODEL	ENGINE	KW	
<p> <b>H</b> = 57 mm  <b>L</b> = 218 mm  <b>W</b> = 213 mm         </p>	FORD	7N159601A	FORD	ECOSPORT			
	FORD	7N159601AA	VOLKSWAGEN	GOL			
	FORD	7N159601AB	VOLKSWAGEN	SAVEIRO			
	VW GROUP	5Y0 129 620					
	FRAM	CA9410					
	GONHER	GAVW628					

## MK-15920

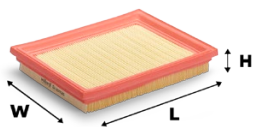

H = 33 mm  
L = 217 mm  
W = 169 mm

CROSS REFERENCES		BRAND	MODEL	ENGINE	KW	
FORD	1729854	FORD	FIESTA HATCHBACK			
FORD	2S619601CA	FORD	FIESTA SEDAN			
MAZDA	2S619601CA					
MAZDA	C60113Z40					
FRAM	CA9435					
FRAM	CA9494					
INTERFIL	F78A40					

## MK-16246

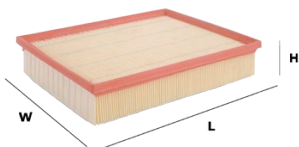

H = 58 mm  
L = 290 mm  
W = 230 mm

CROSS REFERENCES		BRAND	MODEL	ENGINE	KW	
CHRYSLER	05189933AA	DODGE	NITRO			
CHRYSLER	5189933AA	JEEP	LIBERTY			
FRAM	CA10228					
INTERFIL	F99A33					

## MK-1780



H = 32 mm  
L = 385 mm  
W = 205 mm

CROSS REFERENCES		BRAND	MODEL	ENGINE	KW	
FORD	6L2Z9601AA	FORD	EXPLORER			
FRAM	CA10173	FORD	EXPLORER SPORT TRAC			
INTERFIL	F101A73					

## MK-18777

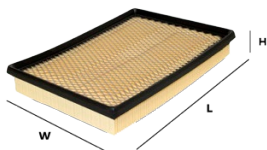

H = 40 mm  
L = 289 mm  
W = 210 mm

CROSS REFERENCES		BRAND	MODEL	ENGINE	KW	
CHRYSLER	05018777AA	JEEP	COMMANDER			
CHRYSLER	05018777AB	JEEP	GRAND CHEROKEE			
CHRYSLER	5018777AA	JEEP	LIBERTY			
CHRYSLER	5018777AB					
FIAT	K05018777AB					
FIAT	K5018777AB					
FRAM	CA8817					
INTERFIL	F88A17					

## MK-19158

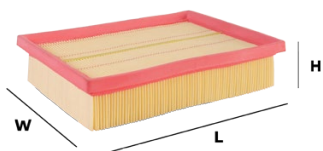

H = 48 mm  
L = 213 mm  
W = 159 mm

CROSS REFERENCES		BRAND	MODEL	ENGINE	KW	
FORD	6E5Z9601GA	FORD	FUSION			
FRAM	CA10092					
INTERFIL	F6EA53					

## MK-20040



H = 39 mm  
L = 318 mm  
W = 193 mm

CROSS REFERENCES		BRAND	MODEL	ENGINE	KW	
TOYOTA	17700-28160	TOYOTA	CAMRY			
TOYOTA	17801-01H10	TOYOTA	CAMRY HYBRID			
TOYOTA	17801-0H020	TOYOTA	HIGHLANDER			
TOYOTA	17801-0H050	TOYOTA	HIGHLANDER HYBRID			
TOYOTA	17801-20040	TOYOTA	SIENNA			
FRAM	CA10327	TOYOTA	SOLARA			
FRAM	CA9360	TOYOTA	VENZA			
INTERFIL	F17AH0					
INTERFIL	F44AQW					
INTERFIL	F93A60					

## MK-21050



H = 49 mm  
L = 242 mm  
W = 176 mm

CROSS REFERENCES		BRAND	MODEL	ENGINE	KW	
TOYOTA	17801-0D060	CHEVROLET	METRO			
TOYOTA	17801-0M020	TOYOTA	COROLLA			
TOYOTA	17801-21050	TOYOTA	MATRIX			
FRAM	CA10190	TOYOTA	YARIS			
INTERFIL	F101A90					

## MK-24086

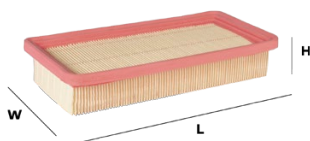

H = 45 mm  
L = 257 mm  
W = 125 mm

CROSS REFERENCES		BRAND	MODEL	ENGINE	KW	
HYUNDAI	28111-1C000	HYUNDAI	GETZ			
HYUNDAI	28113-1C000					
FRAM	CA9632					
FRAM	CA9757					

## MK-25045

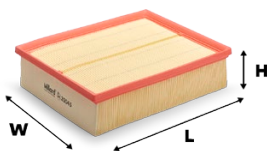

H = 67 mm

L = 266 mm

W = 213 mm

CROSS REFERENCES		BRAND	MODEL	ENGINE	KW	
VW GROUP	06C133843	AUDI	A4			
FRAM	CA9409	AUDI	QUATTRO			
GONHER	GA2124	SEAT	EXEO			
INTERFIL	F94A09					

## MK-25175

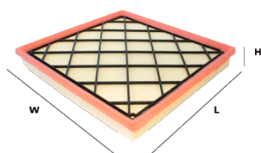

H = 34 mm

L = 255 mm

W = 248 mm

CROSS REFERENCES		BRAND	MODEL	ENGINE	KW	
GM	13272717	CHEVROLET	CRUZE			
GM	13272720					
INTERFIL	F13A27					

## MK-25252

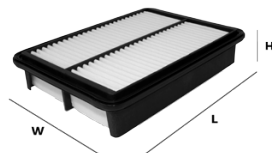

H = 52 mm

L = 268 mm

W = 190 mm

CROSS REFERENCES		BRAND	MODEL	ENGINE	KW	
HYUNDAI	28113-4H000	DODGE	H100 VAN			
INTERFIL	F28A13					

## MK-25270

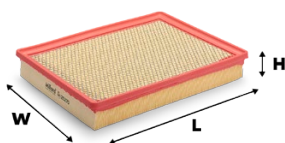

H = 50 mm

L = 328 mm

W = 250 mm

CROSS REFERENCES		BRAND	MODEL	ENGINE	KW	
FIAT	55183307	CHEVROLET	VECTRA			
FIAT	73502069					
GM	9177267					
GM	93172461					
GM	93172463					
GM	93177663					
FRAM	CA10097					
FRAM	CA9652					
FRAM	CA9653					
INTERFIL	F24A61					



## MK-253

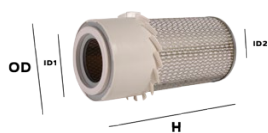

**H** = 290 mm  
**OD** = 157 mm  
**ID1** = 72 mm  
**ID2** = 17 mm

CROSS REFERENCES		BRAND	MODEL	ENGINE	KW	
FIAT	71167808	NISSAN	NV350 URVAN			
FORD	761F9601AA	NISSAN	URVAN			
GM	5141522					
HYUNDAI	28113-44000					
MAZDA	MZ311790					
NISSAN	16546-02N00					
FRAM	CAK253					
GONHER	GA16					
GONHER	GAK16					
INTERFIL	F2KA53					

## MK-26123

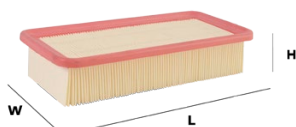

**H** = 56 mm  
**L** = 263 mm  
**W** = 132 mm

CROSS REFERENCES		BRAND	MODEL	ENGINE	KW	
HYUNDAI	28113-1G000	DODGE	ATTITUDE			
HYUNDAI	28113-1G100	HYUNDAI	ACCENT			
KIA	28113-14000	KIA	RIO			
KIA	28113-1G000	KIA	RIOS			
FRAM	CA10088	KIA	RX-V			
INTERFIL	F100A88					

## MK-26934

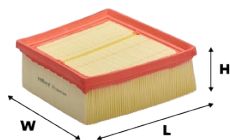

**H** = 68 mm  
**L** = 161 mm  
**W** = 197 mm

CROSS REFERENCES		BRAND	MODEL	ENGINE	KW	
FORD	1810699	FORD	FIESTA			
FORD	1836805					
FORD	8V219601A1A					
FORD	8V219601AA					
MAZDA	Y64513Z40					
MAZDA	Y64513Z40A					
FRAM	CA10653					
INTERFIL	F19A04					

## MK-29058

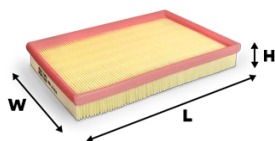

**H** = 41 mm  
**L** = 270 mm  
**W** = 166 mm

CROSS REFERENCES		BRAND	MODEL	ENGINE	KW	
HYUNDAI	28113-02750	DODGE	ATOS			
INTERFIL	F27A50					

## MK-32823

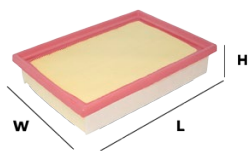

**H** = 51 mm  
**L** = 241 mm  
**W** = 171 mm

CROSS REFERENCES		BRAND	MODEL	ENGINE	KW	
GM	96950990	CHEVROLET	SONIC			
FRAM	CA11222					

## MK-35495

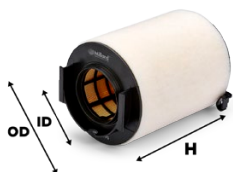

**H** = 222 mm  
**OD** = 138 mm  
**IDI** = 68 mm

CROSS REFERENCES		BRAND	MODEL	ENGINE	KW	
VW GROUP	1FO 129 620	AUDI	A3			
VW GROUP	1FO 129 620	SEAT	LEON			
VW GROUP	1K0 129 607C	VOLKSWAGEN	BORA			
VW GROUP	1K0 129 620C	VOLKSWAGEN	CADDY			
VW GROUP	3C0 129 620	VOLKSWAGEN	JETTA			
VW GROUP	3C0 129 620					
FRAM	CA9800					
GONHER	GAVW629					
INTERFIL	F2KA62					

## MK-35681

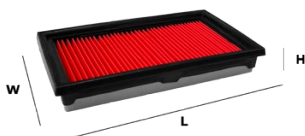

**H** = 34 mm  
**L** = 231 mm  
**W** = 136 mm

CROSS REFERENCES		BRAND	MODEL	ENGINE	KW	
NISSAN	16546-ED000	CHEVROLET	CITY EXPRESS			
NISSAN	16546-ED500	NISSAN	CUBE			
FRAM	CA10234	NISSAN	MARCH			
GONHER	GAD116	NISSAN	NV200			
INTERFIL	F60A00	NISSAN	TIIDA			
		NISSAN	VERSA			

## MK-3660

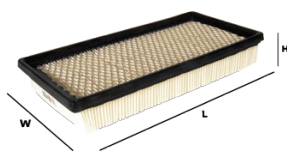

**H** = 42 mm  
**L** = 274 mm  
**W** = 134 mm

CROSS REFERENCES		BRAND	MODEL	ENGINE	KW	
CHRYSLER	4213583	AUDI	A4			
FORD	A800X9601AA	CHRYSLER	VOYAGER			
GM	9974793					
NISSAN	16546-76015					
VW GROUP	049 133 843					
FRAM	CA3441					
FRAM	CA3660					
GONHER	GA271					
INTERFIL	F34A41					
INTERFIL	F36A60					

## MK-38183

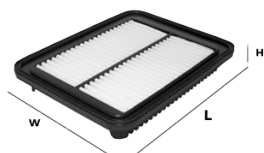

H = 30 mm  
L = 233 mm  
W = 178 mm

CROSS REFERENCES		BRAND	MODEL	ENGINE	KW	
HYUNDAI	28113-0X000	DODGE	I10			
HYUNDAI	28113-0X500					
HYUNDAI	28113-0X000					
HYUNDAI	28113-0X500					
FRAM	CA10630					
INTERFIL	F31A28					

## MK-3901

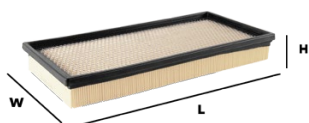

H = 44 mm  
L = 344 mm  
W = 169 mm

CROSS REFERENCES		BRAND	MODEL	ENGINE	KW	
CHRYSLER	53004383	DODGE	DAKOTA			
CHRYSLER	8953004383	DODGE	DURANGO			
CHRYSLER	A24372	DODGE	RAM			
FIAT	K53004383	JEEP	WRANGLER			
MITSUBISHI	MR127077	MITSUBISHI	RAIDER			
FRAM	CA3901	MITSUBISHI	SPACE STAR			
FRAM	CA5739					
GONHER	GA3901					
INTERFIL	F91A13					
INTERFIL	F92A88					

## MK-3916

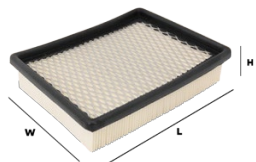

H = 40 mm  
L = 193 mm  
W = 153 mm

CROSS REFERENCES		BRAND	MODEL	ENGINE	KW	
FORD	5029851	CHEVROLET	S10			
FORD	6162293					
FORD	89FF9601AA					
GM	25095333					
GM	25098845					
FRAM	CA3916					
FRAM	CA5205					
INTERFIL	F39A16					

## MK-40048

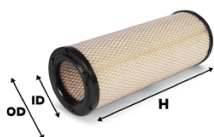

H = 333 mm  
OD = 140 mm  
ID = 82 mm

CROSS REFERENCES		BRAND	MODEL	ENGINE	KW	
GM	15153904	CHEVROLET	EXPRESS 1500			
FRAM	CA9269	CHEVROLET	EXPRESS 2500			
GONHER	GA413R	CHEVROLET	EXPRESS 3500			
INTERFIL	F85A00	CHEVROLET	EXPRESS 4500			
INTERFIL	F92A69	CHEVROLET	EXPRESS VAN			
		CHEVROLET	G SERIES			

## MK-41437

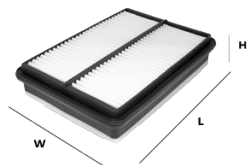

H = 58 mm

L = 273 mm

W = 191 mm

CROSS REFERENCES		BRAND	MODEL	ENGINE	KW
mitsubishi	1500A023	mitsubishi	LANCER		
mitsubishi	1500A086	mitsubishi	OUTLANDER		
mitsubishi	MZ690445	mitsubishi	RVR		
FRAM	CA10525				
INTERFIL	F104A97				

## MK-43080

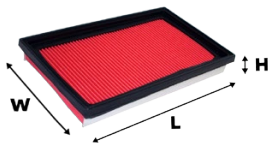

H = 34 mm

L = 278 mm

W = 167 mm

CROSS REFERENCES		BRAND	MODEL	ENGINE	KW
GM	25062212	NISSAN	240SX		
NISSAN	16546-AA020	NISSAN	350Z		
NISSAN	16546-V0100	NISSAN	ALMERA		
NISSAN	AY120-NS001	NISSAN	ALTIMA		
FRAM	CA11711	NISSAN	FRONTIER		
FRAM	CA4309	NISSAN	MAXIMA		
FRAM	CA5825	NISSAN	MURANO		
GONHER	GAD15	NISSAN	PATHFINDER		
INTERFIL	F43A09	NISSAN	X-TERRA		
INTERFIL	FA4309	NISSAN	X-TRAIL		

## MK-4939

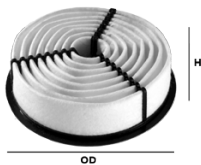

H = 66 mm

OD = 219 mm

ID2 = 28 mm

CROSS REFERENCES		BRAND	MODEL	ENGINE	KW
MAZDA	453	CHEVROLET	LUV		
TOYOTA	1780141090				
TOYOTA	178014109083				
TOYOTA	1780170020				
FRAM	CA2719B				
FRAM	CA4939				
FRAM	CA6546				
INTERFIL	F33A00				
INTERFIL	F49A39				
INTERFIL	F65A60				

## MK-5056

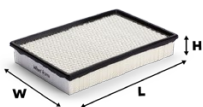

H = 46 mm

L = 286 mm

W = 192 mm

CROSS REFERENCES		BRAND	MODEL	ENGINE	KW
FORD	1232496	FORD	MARAUDER		
FORD	1486710				
FORD	3M519601AA				
FORD	E5TE9601AB				
FORD	E5TE9601ABM				
FORD	E5TZ9601B				
FRAM	CA5056				
FRAM	CA9694				
INTERFIL	F24A96				

## MK-5070

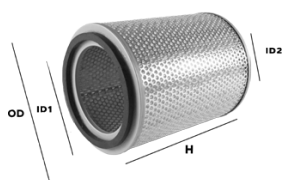

H = 260 mm

OD = 200 mm

ID1 = 133 mm

ID2 = 22 mm

CROSS REFERENCES		BRAND	MODEL	ENGINE	KW	
GM	94156052	CHEVROLET				
NISSAN	16546T9300					
FRAM	CA5070					
GONHER	GA164					
GONHER	GA348					

## MK-5107

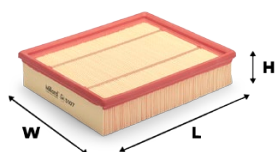

H = 57 mm

L = 254 mm

W = 212 mm

CROSS REFERENCES		BRAND	MODEL	ENGINE	KW	
FORD	78TF9601BA	AUDI	A4			
FORD	85TF9600AA	AUDI	A6			
GM	25062055	AUDI	ALLROAD			
VW GROUP	058 133 843	AUDI	QUATTRO			
VW GROUP	059 133 843A	AUDI	S4			
FRAM	CA5107	AUDI	S6			
FRAM	CA5108	VOLKSWAGEN	PASSAT			
FRAM	CA8080					
INTERFIL	F76A51					
INTERFIL	F80A80					

## MK-51943

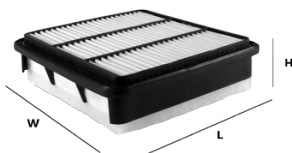

H = 52 mm

L = 239 mm

W = 241 mm

CROSS REFERENCES		BRAND	MODEL	ENGINE	KW	
GM	897251943	MITSUBISHI	L200			
GM	97251943					
MITSUBISHI	1500A098					
MITSUBISHI	M1500A098					
INTERFIL	F15A00					

## MK-52045

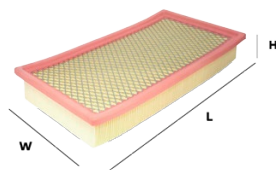

H = 45 mm

L = 305 mm

W = 169 mm

CROSS REFERENCES		BRAND	MODEL	ENGINE	KW	
FORD	7T4Z9601A	FORD	EDGE			
MAZDA	CY0113Z40A	FORD	EXPLORER			
FRAM	CA10242	FORD	FIVE HUNDRED			
INTERFIL	F102A42	FORD	FLEX			
		FORD	FUSION			
		FORD	POLICE INTERCEPTOR			
		FORD	TAURUS			
		FORD	TAURUS X			
		MAZDA	CX-9			
		MAZDA	MAZDA 6			

## MK-52391

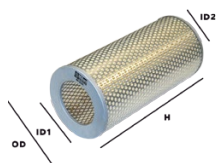

H = 280 mm

OD = 133 mm

ID1 = 81 mm

ID2 = 13 mm

CROSS REFERENCES		BRAND	MODEL	ENGINE	KW
TOYOTA	17801-54100	TOYOTA	HIACE		
TOYOTA	17801-54100-83				
TOYOTA	17801-54100-8T				
TOYOTA	17801-54110				
TOYOTA	17801-64030				
TOYOTA	17801-75010				
FRAM	CA5345				
INTERFIL	F75A01				

## MK-5301

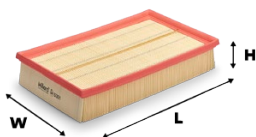

H = 58 mm

L = 309 mm

W = 183 mm

CROSS REFERENCES		BRAND	MODEL	ENGINE	KW
FORD	890X9601JA	VOLKSWAGEN	GOLF		
FORD	890X9601KA	VOLKSWAGEN	PASSAT		
VW GROUP	131 129 620				
VW GROUP	191 129 620				
VW GROUP	859 129 620				
FRAM	CA530				
FRAM	CA5301				
FRAM	CA6545				
GONHER	GAVW120				
INTERFIL	F65A45				

## MK-5357

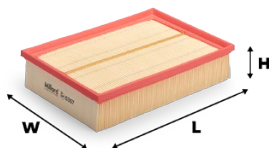

H = 58 mm

L = 257 mm

W = 183 mm

CROSS REFERENCES		BRAND	MODEL	ENGINE	KW
FORD	91FF9601AA	FORD	ESCORT		
FORD	91FF9601AB				
FRAM	CA5357				
GONHER	GA130				
INTERFIL	F81A42				

## MK-5377

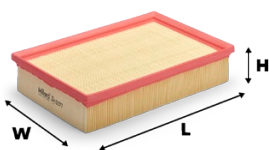

H = 58 mm

L = 274 mm

W = 184 mm

CROSS REFERENCES		BRAND	MODEL	ENGINE	KW
GM	25750701	VOLKSWAGEN	DERBY		
VW GROUP	1L0 129 601C	VOLKSWAGEN	POINTER		
VW GROUP	1L0 129 620A	VOLKSWAGEN	POINTER PICK-UP		
VW GROUP	1L0 129 620C				
VW GROUP	6K0 129 601E				
FRAM	CA5377				
FRAM	CA5904				
FRAM	PA7135				
GONHER	GAVW620				
INTERFIL	F41A16				

## MK-5466



H = 40 mm  
L = 268 mm  
W = 171 mm

CROSS REFERENCES		BRAND	MODEL	ENGINE	KW	
MAZDA	KJ0113Z40	CHEVROLET	PRIZM			
TOYOTA	17801-02030	TOYOTA	COROLLA			
TOYOTA	17801-15070	TOYOTA	MATRIX			
FRAM	CA5466					
FRAM	CA8010					
INTERFIL	F54A66					
INTERFIL	F80A10					

## MK-5468

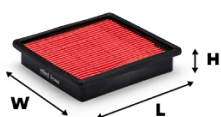

H = 31 mm  
L = 167 mm  
W = 156 mm

CROSS REFERENCES		BRAND	MODEL	ENGINE	KW	
NISSAN	16546-0U800	NISSAN	MICRA			
NISSAN	16546-0U80A					
NISSAN	16546-4100					
NISSAN	16546-41B00					
NISSAN	16546-AX60					
NISSAN	16546-AX600					
NISSAN	16546-AX60A					
FRAM	CA5468					
INTERFIL	F50A58					
INTERFIL	F66A00					

## MK-5496

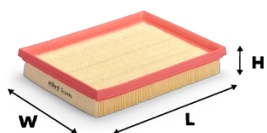

H = 37 mm  
L = 210 mm  
W = 166 mm

CROSS REFERENCES		BRAND	MODEL	ENGINE	KW	
GM	90411702	CHEVROLET	CHEVY C2			
GM	90411732					
GM	90412779					
GM	90412899					
GM	90486296					
GM	90486297					
FRAM	CA5496					
GONHER	GA134					
INTERFIL	F54A96					
INTERFIL	FA5496					

## MK-55267



H = 492 mm  
L = 284 mm  
W = 229 mm

CROSS REFERENCES		BRAND	MODEL	ENGINE	KW	
GM	96628890	CHEVROLET	CAPTIVA			
INTERFIL	F101A15					

## MK-5595



H = 36 mm  
L = 244 mm  
W = 159 mm

CROSS REFERENCES		BRAND	MODEL	ENGINE	KW
FIAT	71736151	MAZDA	PROTEGE		
FIAT	7558338				
FIAT	75583381				
MAZDA	B59513Z40				
MAZDA	B59513Z409A				
MAZDA	ZL0113320B				
FRAM	CA4563				
FRAM	CA5595				
INTERFIL	F55A95				
INTERFIL	F99A48				

## MK-5682

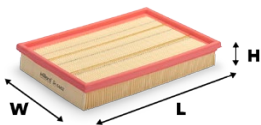

H = 41 mm  
L = 254 mm  
W = 177 mm

CROSS REFERENCES		BRAND	MODEL	ENGINE	KW
FORD	279009130104	FORD	COURIER		
FORD	96MF9601AA	FORD	FIESTA HATCHBACK		
FORD	96MF9601AB	FORD	IKON		
MAZDA	AS0113Z409A				
MAZDA	F20113Z409A				
FRAM	CA5682				
FRAM	CA6541				
GONHER	GA354				
INTERFIL	F56A82				
INTERFIL	F580A				

## MK-5827

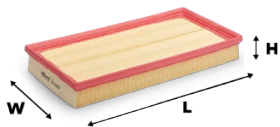

H = 50 mm  
L = 360 mm  
W = 185 mm

CROSS REFERENCES		BRAND	MODEL	ENGINE	KW
VW GROUP	1J0 129 620	AUDI	A3		
VW GROUP	1J0 129 620A	AUDI	QUATTRO		
FRAM	CA5436	AUDI	TT		
FRAM	CA5827	SEAT	LEON		
FRAM	CA8014	SEAT	TOLEDO		
FRAM	CA8715	VOLKSWAGEN	BEETLE		
FRAM	CA9424	VOLKSWAGEN	CABRIO		
GONHER	GAVW621	VOLKSWAGEN	CLASICO		
INTERFIL	F86A02	VOLKSWAGEN	GOLF		
INTERFIL	F87A15	VOLKSWAGEN	JETTA		

## MK-59160

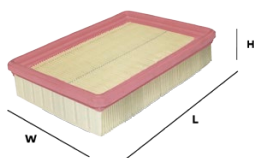

H = 40 mm  
L = 184 mm  
W = 132 mm

CROSS REFERENCES		BRAND	MODEL	ENGINE	KW
FRAM	CA5891	FORD	F SERIES SUPER DUTY		
		FORD	F-450		
		FORD	F-550		



## MK-5929

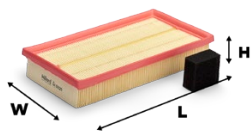

H = 48 mm  
L = 266 mm  
W = 146 mm

CROSS REFERENCES		BRAND	MODEL	ENGINE	KW	
FORD	7T169601AA	FORD	FOCUS			
FORD	7T169601AB					
GM	25062209					
FRAM	CA4576					
FRAM	CA5929					
FRAM	CA8969					
INTERFIL	F16A88					
INTERFIL	F20A82					
INTERFIL	F45A76					
INTERFIL	F96A69					

## MK-5970

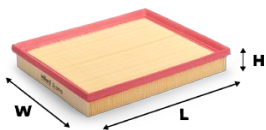

H = 41 mm  
L = 293 mm  
W = 235 mm

CROSS REFERENCES		BRAND	MODEL	ENGINE	KW	
GM	13271041	CHEVROLET	ASTRA			
GM	24443113	CHEVROLET	ZAFIRA			
GM	89001934					
GM	90531003					
GM	91181912					
GM	93192885					
FRAM	C301302					
FRAM	CA10070					
FRAM	CA5970					
INTERFIL	F19A35					

## MK-6362



H = 174 mm  
OD = 202 mm  
ID1 = 135 mm

CROSS REFERENCES		BRAND	MODEL	ENGINE	KW	
HYUNDAI	28113-32510	DODGE	H100			
MITSUBISHI	MD603629					
MITSUBISHI	MD603932					
MITSUBISHI	MR571477					
MITSUBISHI	MZ311788					
MITSUBISHI	XD603932					
FRAM	CA5290					
FRAM	CA6362					
INTERFIL	F63A62					
INTERFIL	F95A89					

## MK-64676

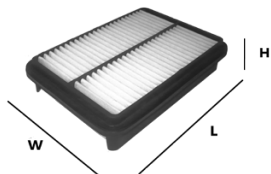

H = 50 mm  
L = 248 mm  
W = 172 mm

CROSS REFERENCES		BRAND	MODEL	ENGINE	KW	
GM	94376335	TOYOTA	4RUNNER			
GM	94376353					
MAZDA	JE4813Z40					
TOYOTA	17801-08010					
TOYOTA	17801-35020					
TOYOTA	17801-35020-83					
TOYOTA	17801-55020					
VW GROUP	J17 801 35020					
FRAM	CA6690					
INTERFIL	F66A90					

## MK-6479

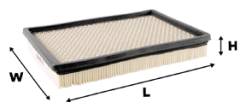

**H** = 40 mm  
**L** = 270 mm  
**W** = 202 mm

CROSS REFERENCES		BRAND	MODEL	ENGINE	KW
GM	25096932	CHEVROLET	S10		
FRAM	CA6479				
INTERFIL	F64A79				
INTERFIL	F87A54				

## MK-6544

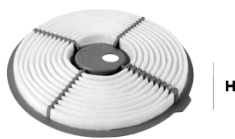

**OD**  
**H** = 40 mm  
**OD** = 255 mm  
**ID1** = 22 mm

CROSS REFERENCES		BRAND	MODEL	ENGINE	KW
TOYOTA	17801-15060	TOYOTA	4RUNNER		
TOYOTA	17801-15060-83	TOYOTA	LAND CRUISER		
FRAM	CA6544	TOYOTA	SEQUOIA		
GONHER	GA286	TOYOTA	TUNDRA		
INTERFIL	F65A44				

## MK-6591

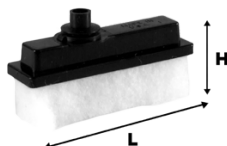

**H** = 6 mm  
**L** = 11 mm  
**W** = 3 mm

CROSS REFERENCES		BRAND	MODEL	ENGINE	KW
FORD	E5TZ9D695A	FORD	F SERIES SUPER DUTY		
FORD	E7TE9D695BA				
FORD	E7TZ9D695A				
FRAM	BA6591				
GONHER	GA176				
INTERFIL	IBE1047				

## MK-6807



**H** = 41 mm  
**L** = 244 mm  
**W** = 143 mm

CROSS REFERENCES		BRAND	MODEL	ENGINE	KW
HONDA	17200PT2000	HONDA	ACCORD		
HONDA	17220P45G00				
HONDA	17220PT0003				
HONDA	17220PT2000				
HONDA	17220PT2305				
HONDA	17220PY2000				
FRAM	CA5431				
FRAM	CA6807				
GONHER	GA163				
INTERFIL	F68A07				

## MK-68338

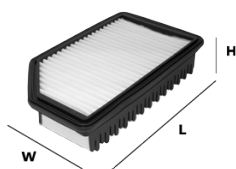

**H** = 54 mm  
**L** = 256 mm  
**W** = 146 mm

CROSS REFERENCES		BRAND	MODEL	ENGINE	KW	
HYUNDAI	28113-1R100	HYUNDAI	ACCENT			
HYUNDAI	28113-1V100	HYUNDAI	VELOSTER			
INTERFIL	F28A00	KIA	RIO			
		KIA	SOUL			

## MK-6850



**H** = 61 mm  
**OD** = 326 mm  
**ID1** = 12 mm  
**ID2** = 12 mm

CROSS REFERENCES		BRAND	MODEL	ENGINE	KW	
NISSAN	16546-86G00	NISSAN	FRONTIER			
FRAM	CA6850	NISSAN	NP300			
INTERFIL	F68A50	NISSAN	PICK-UP			
		NISSAN	URVAN			
		NISSAN	X-TERRA			

## MK-6900

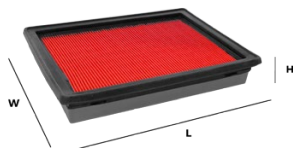

**H** = 35 mm  
**L** = 228 mm  
**W** = 168 mm

CROSS REFERENCES		BRAND	MODEL	ENGINE	KW	
HONDA	17220P2A000	NISSAN	JUKE			
NISSAN	16546-17B00	NISSAN	LUCINO			
NISSAN	16546-AA030	NISSAN	ROGUE			
FRAM	CA5619	NISSAN	ROGUE SELECT			
FRAM	CA6900	NISSAN	SENTRA			
GONHER	GAD117	NISSAN	TSURU			
INTERFIL	F353A	NISSAN	VERSA			
INTERFIL	F41A00	NISSAN	X-TRAIL			
INTERFIL	F66A19					
INTERFIL	F66A19A					

## MK-69754

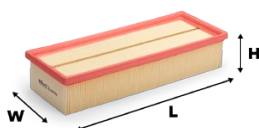

**H** = 78 mm  
**L** = 334 mm  
**W** = 135 mm

CROSS REFERENCES		BRAND	MODEL	ENGINE	KW	
VW GROUP	1K0 129 620	AUDI				
VW GROUP	1K0 129 620D	SEAT				
VW GROUP	1K0 129 620E	VOLKSWAGEN				
VW GROUP	3C0 129 620A					
VW GROUP	5C0 129 620					
FRAM	CA10057					
FRAM	CA9711					
GONHER	GAVW619					
INTERFIL	F103A28					
INTERFIL	FIKA01					

## MK-7020

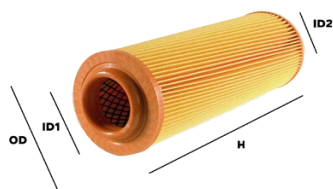

**H** = 310 mm

**OD** = 105 mm

**ID1** = 53 mm

**ID2** = 53 mm

CROSS REFERENCES		BRAND	MODEL	ENGINE	KW
FORD	2N1U9601CB	FORD	ECOSPORT		
INTERFIL	F96A21				

## MK-7142

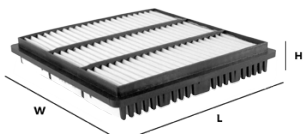

**H** = 37 mm

**L** = 226 mm

**W** = 224 mm

CROSS REFERENCES		BRAND	MODEL	ENGINE	KW
mitsubishi	MD620456	MITSUBISHI	3000		
mitsubishi	MD620472	MITSUBISHI	MONTERO SPORT		
mitsubishi	MR571471				
mitsubishi	MZ311783				
mitsubishi	MZ311783T				
mitsubishi	MZ690194				
FRAM	CA5506				
FRAM	CA7142				
INTERFIL	F65A76				
INTERFIL	F71A42				

## MK-72373



**H** = 41 mm

**L** = 329 mm

**W** = 109 mm

CROSS REFERENCES		BRAND	MODEL	ENGINE	KW
HONDA	17220PWA000	HONDA	FIT		
HONDA	17220PWA003				
HONDA	17220PWAY00				
HONDA	17220PWC000				
HONDA	17220PWC505HE				
FRAM	CA9945				
INTERFIL	F20A10				

## MK-7344

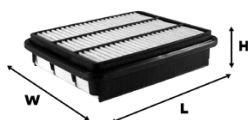

**H** = 50 mm

**L** = 233 mm

**W** = 187 mm

CROSS REFERENCES		BRAND	MODEL	ENGINE	KW
MAZDA	KL4713Z40	CHRYSLER	CIRRUS		
MAZDA	KL4713Z409A	CHRYSLER	SEBRING		
FRAM	CA7344	DODGE	STRATUS		
INTERFIL	F73A44	MITSUBISHI	ECLIPSE		
		MITSUBISHI	GALANT		

## MK-7351

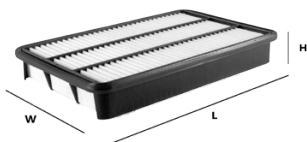

H = 41 mm  
L = 310 mm  
W = 184 mm

CROSS REFERENCES		BRAND	MODEL	ENGINE	KW	
TOYOTA	17801-03010	TOYOTA	SIENNA			
TOYOTA	17801-74060	TOYOTA	SOLARA			
FRAM	CA7351					
INTERFIL	F73A51					

## MK-73667

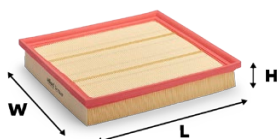

H = 46 mm  
L = 274 mm  
W = 250 mm

CROSS REFERENCES		BRAND	MODEL	ENGINE	KW	
FORD	1729416	FORD	TRANSIT			
FORD	6C119601CB					
FRAM	CA10290					
INTERFIL	F6CA11					

## MK-7420

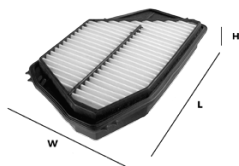

H = 55 mm  
L = 305 mm  
W = 185 mm

CROSS REFERENCES		BRAND	MODEL	ENGINE	KW	
HONDA	17220POA000	HONDA	ODYSSEY			
HONDA	17220POAA00					
HONDA	17220POA000					
HONDA	17220POAA00					
HONDA	17220POCY00					
FRAM	CA7420					
INTERFIL	F74A20					

## MK-7421

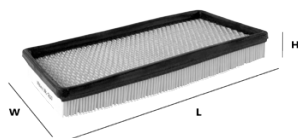

H = 40 mm  
L = 293 mm  
W = 153 mm

CROSS REFERENCES		BRAND	MODEL	ENGINE	KW	
FIAT	71736121	CHEVROLET	BLAZER			
FIAT	7633139	CHEVROLET	S10			
FIAT	76331391					
FORD	5025078					
FORD	900X9601ALA					
GM	25098463					
FRAM	CA5267					
FRAM	CA7421					
GONHER	GA165					

## MK-7431

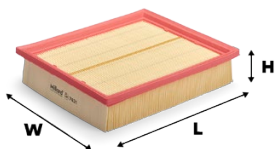

H = 59 mm  
L = 265 mm  
W = 227 mm

CROSS REFERENCES		BRAND	MODEL	ENGINE	KW	
VW GROUP	1H0 129 620	AUDI	A3			
VW GROUP	1HM 129 620	VOLKSWAGEN	CABRIO			
FRAM	CA5370	VOLKSWAGEN	GOLF			
FRAM	CA7431	VOLKSWAGEN	JETTA			
GONHER	GAVW121					
INTERFIL	F74A21					
INTERFIL	F74A31					

## MK-7440

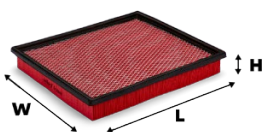

H = 36 mm  
L = 290 mm  
W = 245 mm

CROSS REFERENCES		BRAND	MODEL	ENGINE	KW	
CHRYSLER	53007386	JEEP	CHEROKEE			
CHRYSLER	53007386AB	JEEP	GRAND CHEROKEE			
CHRYSLER	53030688	NISSAN	ARMADA			
FIAT	K53007386AB	NISSAN	FRONTIER			
NISSAN	16546-7S000	NISSAN	NV1500			
NISSAN	16546-7S015	NISSAN	NV2500			
FRAM	CA7440	NISSAN	NV3500			
FRAM	CA8858	NISSAN	PATHFINDER			
GONHER	GA300	NISSAN	TITAN			
INTERFIL	F74A40	NISSAN	X-TERRA			

## MK-7597

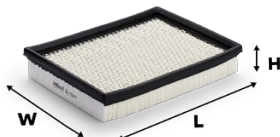

H = 41 mm  
L = 234 mm  
W = 178 mm

CROSS REFERENCES		BRAND	MODEL	ENGINE	KW	
GM	25099149	CHEVROLET	CUTLASS			
GM	25165627	CHEVROLET	MALIBU			
GM	93183040	CHEVROLET	S10			
FRAM	CA7597					
GONHER	GA279					
INTERFIL	F75A97					
INTERFIL	FA7597					

## MK-7617



H = 52 mm  
L = 292 mm  
W = 141 mm

CROSS REFERENCES		BRAND	MODEL	ENGINE	KW	
GM	25175325	CHEVROLET	TRACKER			
GM	96068629					
FRAM	CA7617					
INTERFIL	F76A17					

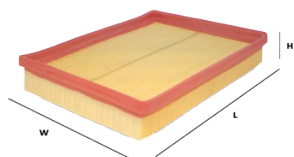
**MK-76429**

H = 42 mm  
L = 258 mm  
W = 201 mm

CROSS REFERENCES		BRAND	MODEL	ENGINE	KW	
KIA	28113-2G000	KIA	MAGENTIS (CANADA)			
		KIA	OPTIMA			
		KIA	RONDO			

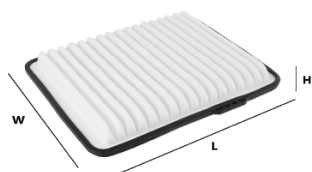
**MK-76855**

H = 53 mm  
L = 312 mm  
W = 256 mm

CROSS REFERENCES		BRAND	MODEL	ENGINE	KW	
GM	15942429	CHEVROLET	COLORADO			
FRAM	CA10466					
INTERFIL	F104A66					

**MK-7756**

H = 7 mm  
L = 11 mm  
W = 3 mm

CROSS REFERENCES		BRAND	MODEL	ENGINE	KW	
FRAM	BA7756	FORD	E SERIES (VANS)			
FRAM	CA7756	FORD	F SERIES			
INTERFIL	IBE1603					

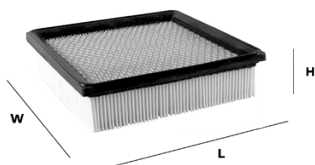
**MK-7764**

H = 49 mm  
L = 199 mm  
W = 192 mm

CROSS REFERENCES		BRAND	MODEL	ENGINE	KW	
HONDA	17220P2FY00	CHRYSLER	PT CRUISER			
HONDA	17220P2J003	HONDA	CR-V			
HONDA	17220P2M505					
HONDA	17220P2PA00					
HONDA	17220PM2Y00					
HONDA	17220PM4003					
FRAM	CA10192					
FRAM	CA7764					
INTERFIL	F16A91					
INTERFIL	F77A64					

## MK-8000



H = 46 mm

L = 253 mm

W = 173 mm

CROSS REFERENCES		BRAND	MODEL	ENGINE	KW	
HYUNDAI	28113-08000	HYUNDAI	TUCSON			
KIA	28113-08000	KIA	SPORTAGE			
FRAM	CA10086					

## MK-8004

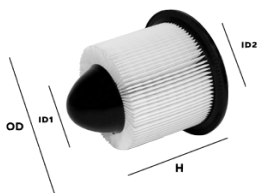

H = 199 mm

OD = 210 mm

ID1 = 108 mm

CROSS REFERENCES		BRAND	MODEL	ENGINE	KW	
FORD	F50X9601A	FORD	CLUB WAGON			
FORD	F50X9601AB	FORD	E SERIES (VANS)			
FORD	F50Y9601A	FORD	E-150			
FORD	F50Y9601AB	FORD	E-250			
FORD	F50Z9601BA	FORD	E-350			
FORD	F50X9601AB	FORD	E-450			
FORD	F6ZZ9601A	FORD	EXCURSION			
FORD	YC3Z9601AA	FORD	EXPEDITION			
FRAM	CA8004	FORD	F SERIES			
FRAM	CA8039	FORD	LOBO			

## MK-80146



H = 44 mm

L = 227 mm

W = 197 mm

CROSS REFERENCES		BRAND	MODEL	ENGINE	KW	
HONDA	17220RNAA00	HONDA	CIVIC			
HONDA	17220RNDM00					
FRAM	CA10165					
INTERFIL	F17A22					

## MK-8038

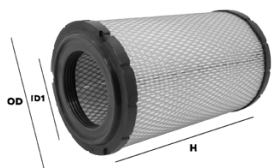

H = 282 mm

OD = 165 mm

ID1 = 91 mm

CROSS REFERENCES		BRAND	MODEL	ENGINE	KW	
GM	25168081	CHEVROLET	C SERIES			
FRAM	CA8038	CHEVROLET	K SERIES			
INTERFIL	F80A38	CHEVROLET	KODIAK			
		CHEVROLET	P SERIES			
		CHEVROLET	SILVERADO			
		CHEVROLET	SUBURBAN			
		CHEVROLET	TAHOE			



## MK-8067



H = 52 mm  
L = 310 mm  
W = 199 mm

CROSS REFERENCES		BRAND	MODEL	ENGINE	KW	
GM	970350300	CHEVROLET	LUV			
GM	97111423					
TOYOTA	178010W010					
FRAM	CA7417					
FRAM	CA8067					
FRAM	CA9079					
INTERFIL	F74A17					
INTERFIL	F74A27					

## MK-8069



H = 56 mm  
L = 228 mm  
W = 200 mm

CROSS REFERENCES		BRAND	MODEL	ENGINE	KW	
GM	25311970	CHEVROLET	TRACKER			
GM	91174457					
FRAM	CA8069					
INTERFIL	F80A69					

## MK-8141



H = 149 mm  
OD = 175 mm  
ID1 = 81 mm

CROSS REFERENCES		BRAND	MODEL	ENGINE	KW	
FORD	F67Z9601AA	FORD	EXPLORER			
FRAM	CA8141					
INTERFIL	F81A41					

## MK-8208



H = 51 mm  
L = 213 mm  
W = 204 mm

CROSS REFERENCES		BRAND	MODEL	ENGINE	KW	
mitsubishi	MR188657	mitsubishi	LANCER			
mitsubishi	MR258421	mitsubishi	MIRAGE			
mitsubishi	MR373756	mitsubishi	OUTLANDER			
mitsubishi	MR464177					
mitsubishi	MR481794					
mitsubishi	MR481795					
mitsubishi	MR552951					
mitsubishi	XR188657					
mitsubishi	XR552951					
FRAM	CA8208					

## MK-82139

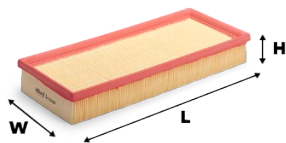

H = 49 mm

L = 336 mm

W = 145 mm

CROSS REFERENCES		BRAND	MODEL	ENGINE	KW
FORD	1581167	FORD	MONDEO		
FORD	1S719601A1B				
FORD	1S719601AA				
FORD	1S719601AB				
FRAM	CA9126				
INTERFIL	F583A				

## MK-8243

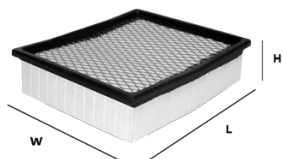

H = 56 mm

L = 223 mm

W = 193 mm

CROSS REFERENCES		BRAND	MODEL	ENGINE	KW
FORD	F77Z9601AA	FORD	EXCURSION		
FRAM	CA8243	FORD	EXPLORER		
GONHER	GA158	FORD	F SERIES		
INTERFIL	F82A43	FORD	F-450		
INTERFIL	F89A25	FORD	F-550		
INTERFIL	F95A63	FORD	RANGER		
		MAZDA	B-2300		
		MAZDA	B-2500		
		MAZDA	B-3000		
		MAZDA	B-4000		

## MK-83293

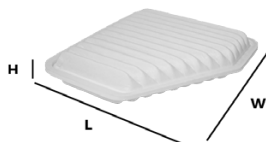

H = 54 mm

L = 256 mm

W = 239 mm

CROSS REFERENCES		BRAND	MODEL	ENGINE	KW
TOYOTA	17801-31120	TOYOTA	AVALON		
TOYOTA	17801-AD010	TOYOTA	CAMRY		
INTERFIL	F11A69	TOYOTA	COROLLA		
		TOYOTA	MATRIX		
		TOYOTA	RAV 4		
		TOYOTA	VENZA		

## MK-8548

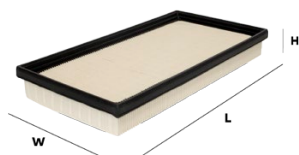

H = 40 mm

L = 334 mm

W = 170 mm

CROSS REFERENCES		BRAND	MODEL	ENGINE	KW
KIA	OK2A5-13Z40A	KIA	SEPHIA		
KIA	OK2A5-13Z40	KIA	SPECTRA		
KIA	OK2A5-13Z40A				
FRAM	CA8548				
INTERFIL	F82A08				

## MK-8732



H = 36 mm  
L = 296 mm  
W = 219 mm

CROSS REFERENCES		BRAND	MODEL	ENGINE	KW	
GM	6553450	CHEVROLET	OPTRA			
GM	965534460					
GM	96553450					
FRAM	CA10519					
INTERFIL	F34A50					

## MK-8805

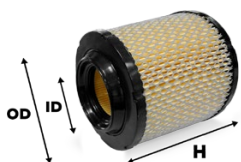

H = 166 mm  
OD = 142 mm  
ID = 62 mm

CROSS REFERENCES		BRAND	MODEL	ENGINE	KW	
CHRYSLER	4891097AA	DODGE	NEON			
FRAM	CA8805					
INTERFIL	F10A45					
INTERFIL	F88A05					

## MK-8911

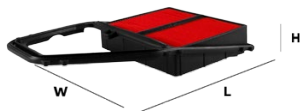

H = 56 mm  
L = 318 mm  
W = 202 mm

CROSS REFERENCES		BRAND	MODEL	ENGINE	KW	
HONDA	17220PLC000	HONDA	CIVIC			
HONDA	17220PMRA00					
FRAM	CA8911					

## MK-8964

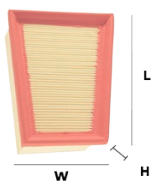

H = 73 mm  
L = 175 mm  
W = 141 mm

CROSS REFERENCES		BRAND	MODEL	ENGINE	KW	
GM	91159955	NISSAN	APRIO			
GM	93161448	NISSAN	PLATINA			
NISSAN	16546-00QAA					
NISSAN	16546-00QAU					
FRAM	CA10249					
FRAM	CA8964					
INTERFIL	F57A24					
INTERFIL	F94A93					

## MK-8970

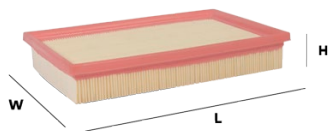

H = 40 mm

L = 246 mm

W = 168 mm

CROSS REFERENCES		BRAND	MODEL	ENGINE	KW	
FORD	HE1923603	DODGE	VERNA			
HYUNDAI	28113-22600	HYUNDAI	ACCENT			
MAZDA	HE1923603					
MAZDA	HE19236039A					
NISSAN	16546-HC000					
FRAM	CA11655					
FRAM	CA3997					
FRAM	CA9082					
INTERFIL	F44AW2					
INTERFIL	F89A70					

## MK-8995

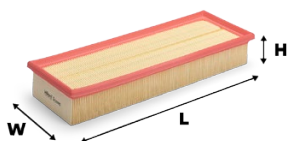

H = 58 mm

L = 368 mm

W = 134 mm

CROSS REFERENCES		BRAND	MODEL	ENGINE	KW	
VW GROUP	6K0 129 620B	SEAT	CORDOBA			
FRAM	CA8995	SEAT	IBIZA			
INTERFIL	F87A60	VOLKSWAGEN	DERBY			
INTERFIL	F96A20					

## MK-8997

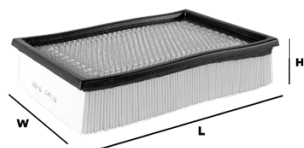

H = 55 mm

L = 254 mm

W = 180 mm

CROSS REFERENCES		BRAND	MODEL	ENGINE	KW	
FORD	5162051	FORD	ESCAPE			
FORD	YFIZ9601AA	FORD	TAURUS			
FORD	YL8Z9601AA	MAZDA	TRIBUTE			
MAZDA	YF0913Z40	MAZDA	TRIBUTE HYBRID			
MAZDA	YF0913Z40A					
MAZDA	YL8Z9601AA					
FRAM	CA8997					
INTERFIL	F89A97					

## MK-9015

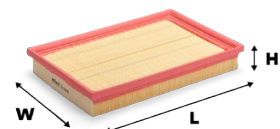

H = 41 mm

L = 288 mm

W = 188 mm

CROSS REFERENCES		BRAND	MODEL	ENGINE	KW	
GM	25062227	SEAT	CORDOBA			
GM	90322261	SEAT	IBIZA			
VW GROUP	032 129 620B	VOLKSWAGEN	BEETLE			
VW GROUP	036 129 620D	VOLKSWAGEN	CROSSFOX			
VW GROUP	036 198 620	VOLKSWAGEN	LUPO			
FRAM	CA5397	VOLKSWAGEN	POLO			
FRAM	CA8886	VOLKSWAGEN	SPORT VAN			
FRAM	CA9015					
FRAM	CA9519					
INTERFIL	F36A12					

## MK-9074

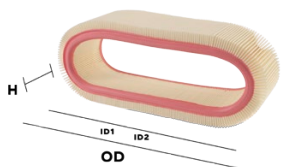

H = 92 mm

OD = 259 mm

ID1 = 200 mm

ID2 = 200 mm

CROSS REFERENCES		BRAND	MODEL	ENGINE	KW		
FRAM	CA10447	NISSAN	APRIO				
FRAM	CA9074						
INTERFIL	F381A						

## MK-9115



H = 50 mm

L = 251 mm

W = 120 mm

CROSS REFERENCES		BRAND	MODEL	ENGINE	KW		
TOYOTA	17801-0Y010	TOYOTA	ECHO				
TOYOTA	17801-21030	TOYOTA	YARIS				
FRAM	CA9115						
FRAM	CA9295						
INTERFIL	F21A03						

## MK-91485



H = 28 mm

L = 225 mm

W = 193 mm

CROSS REFERENCES		BRAND	MODEL	ENGINE	KW		
GM	96591485	CHEVROLET	MATIZ				
FRAM	CA10767						
INTERFIL	F14A85						

## MK-92369

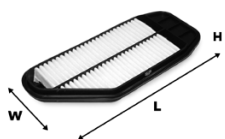

H = 33 mm

L = 361 mm

W = 157 mm

CROSS REFERENCES		BRAND	MODEL	ENGINE	KW		
CHEVROLET	J96827723	CHEVROLET	SPARK				
GM	96827723						
FRAM	CA11071						
INTERFIL	F96A23						

## MK-93235

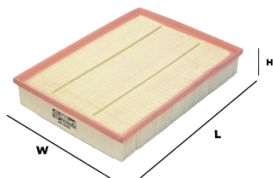

**H** = 58 mm

**L** = 354 mm

**W** = 264 mm

CROSS REFERENCES		BRAND	MODEL	ENGINE	KW	
VW GROUP	2E0 129 620B	VOLKSWAGEN	CRAFTER			
VW GROUP	2E0 129 620D					
VW GROUP	2H0 127 401					
FRAM	CA10330					
INTERFIL	F103A30					

## MK-9332

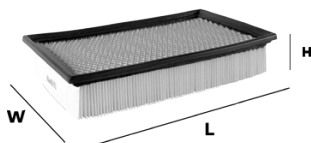

**H** = 55 mm

**L** = 289 mm

**W** = 179 mm

CROSS REFERENCES		BRAND	MODEL	ENGINE	KW	
FORD	1L2Z9601AA	FORD	EXPLORER			
FRAM	CA9332	FORD	EXPLORER SPORT TRAC			
INTERFIL	F93A32					

## MK-9345

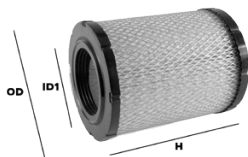

**H** = 203 mm

**OD** = 152 mm

**ID1** = 81 mm

CROSS REFERENCES		BRAND	MODEL	ENGINE	KW	
GM	15036141	CHEVROLET	BLAZER			
FRAM	CA9345	CHEVROLET	COBALT			
INTERFIL	F93A45	CHEVROLET	TRAIL BLAZER			

## MK-9391

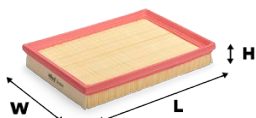

**H** = 41 mm

**L** = 292 mm

**W** = 206 mm

CROSS REFERENCES		BRAND	MODEL	ENGINE	KW	
GM	13270886	CHEVROLET	CORSA			
GM	13270887	CHEVROLET	MERIVA			
GM	55355096	CHEVROLET	TORNADO			
GM	9129747	CHRYSLER	300			
GM	9196120	CHRYSLER	300C			
GM	93193036	DODGE	CHALLENGER			
FRAM	CA10144	DODGE	CHARGER			
FRAM	CA9391	DODGE	MAGNUM			
INTERFIL	F56A26					

## MK-9392

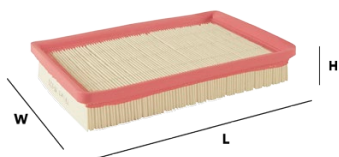

H = 40 mm  
L = 254 mm  
W = 173 mm

CROSS REFERENCES		BRAND	MODEL	ENGINE	KW	
HYUNDAI	28113-2D000	HYUNDAI	ELANTRA			
HYUNDAI	28113-2D001	HYUNDAI	TIBURON			
HYUNDAI	28113-2F000	KIA	SPECTRA			
KIA	28113-2D001					
KIA	28113-2F000					
FRAM	CA9392					
INTERFIL	F93A92					

## MK-9401

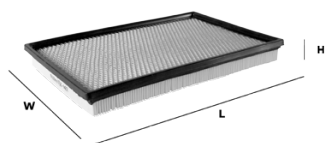

H = 39 mm <sup>COUNTRY</sup>  
L = 350 mm  
W = 238 mm

CROSS REFERENCES		BRAND	MODEL	ENGINE	KW	
CHRYSLER	53032404AA	CHRYSLER	PACIFICA			
FRAM	CA9401	CHRYSLER	TOWN & AMP			
INTERFIL	F24A04	CHRYSLER	VOYAGER			
		DODGE	CARAVAN			
		DODGE	GRAND CARAVAN			
		DODGE	RAM			
		DODGE	RAM 4000			

## MK-9431

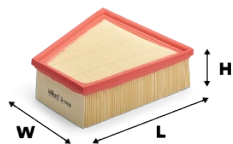

H = 68 mm  
L = 219 mm  
W = 216 mm

CROSS REFERENCES		BRAND	MODEL	ENGINE	KW	
VW GROUP	5ZO 129 620	SEAT	CORDOBA			
VW GROUP	5ZO 129 620A	SEAT	IBIZA			
VW GROUP	6Q0 129 620A	VOLKSWAGEN	POLO			
VW GROUP	6Q0 129 620B					
VW GROUP	6Y0 129 620					
FRAM	CA10409					
FRAM	CA9341					
FRAM	CA9431					
INTERFIL	F6QA01					
INTERFIL	F7NA15					

## MK-9482



H = 48 mm  
L = 289 mm  
W = 150 mm

CROSS REFERENCES		BRAND	MODEL	ENGINE	KW	
TOYOTA	17801-0D010	TOYOTA	COROLLA			
TOYOTA	17801-0D011	TOYOTA	MATRIX			
TOYOTA	17801-0D020	TOYOTA	MATRIX HYBRID			
TOYOTA	17801-22020					
TOYOTA	SU003-00319-00					
FRAM	CA9482					
INTERFIL	F26A75					
INTERFIL	F94A82					

## MK-94973



H = 57 mm  
L = 179 mm  
W = 168 mm

CROSS REFERENCES		BRAND	MODEL	ENGINE	KW
HONDA	17220RB0000	HONDA	CITY		
INTERFIL	F106A50	HONDA	FIT		

## MK-95021

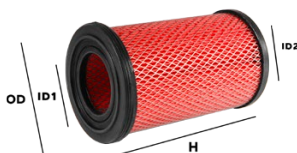

H = 224 mm  
OD = 143 mm  
ID1 = 72 mm  
ID2 = 62 mm

CROSS REFERENCES		BRAND	MODEL	ENGINE	KW
NISSAN	16546-95001	NISSAN	D22 (FRONTIER)		
NISSAN	16546-9S000	NISSAN	NP300		
NISSAN	16546-9S001	NISSAN	PICK-UP		
NISSAN	16546-9S00B				
NISSAN	16546-E6810				
NISSAN	16546-VK500				
NISSAN	16546-VK501				
INTERFIL	F10A01				

## MK-95334

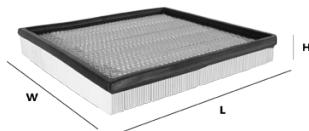

H = 46 mm  
L = 266 mm  
W = 252 mm

CROSS REFERENCES		BRAND	MODEL	ENGINE	KW
FORD	7C3Z9601A	FORD	E SERIES (VANS)		
FRAM	CA10262	FORD	EXPEDITION		
INTERFIL	F18A83	FORD	F SERIES		
		FORD	F SERIES SUPER DUTY		
		FORD	F-150		
		FORD	F-250		
		FORD	F-350		
		FORD	F-450		
		FORD	F-550		
		FORD	LOBO		

## MK-96431



H = 52 mm  
L = 276 mm  
W = 189 mm

CROSS REFERENCES		BRAND	MODEL	ENGINE	KW
MAZDA	LF50113Z40A	MAZDA	MAZDA 3		
MAZDA	LF5013Z409A	MAZDA	MAZDA 5		
MAZDA	LF5013Z40A	MAZDA	MAZDASPEED3		
FRAM	CA9898				
INTERFIL	F98A98				



## MK-9683

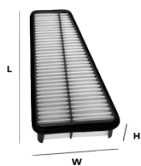

H = 62 mm  
L = 355 mm  
W = 164 mm

CROSS REFERENCES		BRAND	MODEL	ENGINE	KW	
TOYOTA	17801-0P010	TOYOTA	4RUNNER			
TOYOTA	17801-31090	TOYOTA	FJ CRUISER			
FRAM	CA9683	TOYOTA	TACOMA			
INTERFIL	F96A83	TOYOTA	TUNDRA			

## MK-9684

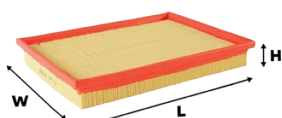

H = 41 mm  
L = 301 mm  
W = 223 mm

CROSS REFERENCES		BRAND	MODEL	ENGINE	KW	
GM	13271043	CHEVROLET	ASTRA			
GM	9194405	CHEVROLET	ZAFIRA			
GM	9202382					
GM	93188944					
GM	93192883					
FRAM	CA9684					

## MK-9687

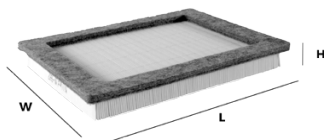

H = 36 mm  
L = 287 mm  
W = 216 mm

CROSS REFERENCES		BRAND	MODEL	ENGINE	KW	
FORD	4L3Z9601BA	FORD	E SERIES (VANS)			
FRAM	CA9687	FORD	EXPEDITION			
INTERFIL	F96A87	FORD	F SERIES			
		FORD	F SERIES SUPER DUTY			
		FORD	F-450			
		FORD	F-550			
		FORD	LOBO			

## MK-9895

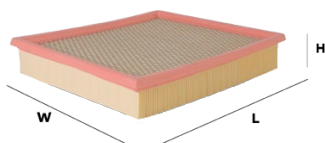

H = 45 mm  
L = 253 mm  
W = 234 mm

CROSS REFERENCES		BRAND	MODEL	ENGINE	KW	
FORD	4R3Z9601AA	FORD	MUSTANG			
FRAM	CA9895					
INTERFIL	F98A95					

## MK-9896

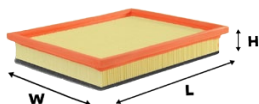

**H** = 42 mm

**L** = 257 mm

**W** = 222 mm

CROSS REFERENCES		BRAND	MODEL	ENGINE	KW		
FORD	XS5X9601DA	FORD	KA				
FRAM	CA8736						
FRAM	CA9759						
INTERFIL	F87A36						

## MK-9902



**H** = 44 mm

**L** = 221 mm

**W** = 186 mm

CROSS REFERENCES		BRAND	MODEL	ENGINE	KW		
GM	96536696	CHEVROLET	AVEO (MEXICO)				
FRAM	CA9902	CHEVROLET	AVEO (USA)				
INTERFIL	F99A02						





## FILTROS DE COMBUSTIBLE

---

La combustión perfecta necesita un filtro capaz de retener los elementos contaminantes con eficiencia. Para tal efecto, los elementos filtrantes compuestos en material celulósico o sintético, constituidos por fibras de poliéster permiten que la gasolina alcance un alto desempeño. En los vehículos diésel la combustión perfecta es llevada a cabo gracias a la tecnología de plisado y a la experiencia de Millard® en los más exigentes sistemas de inyección convencionales y common rail. La retención de los contaminantes producidos por la oxidación y la condensación de agua permiten un óptimo nivel de funcionamiento de este fluido.

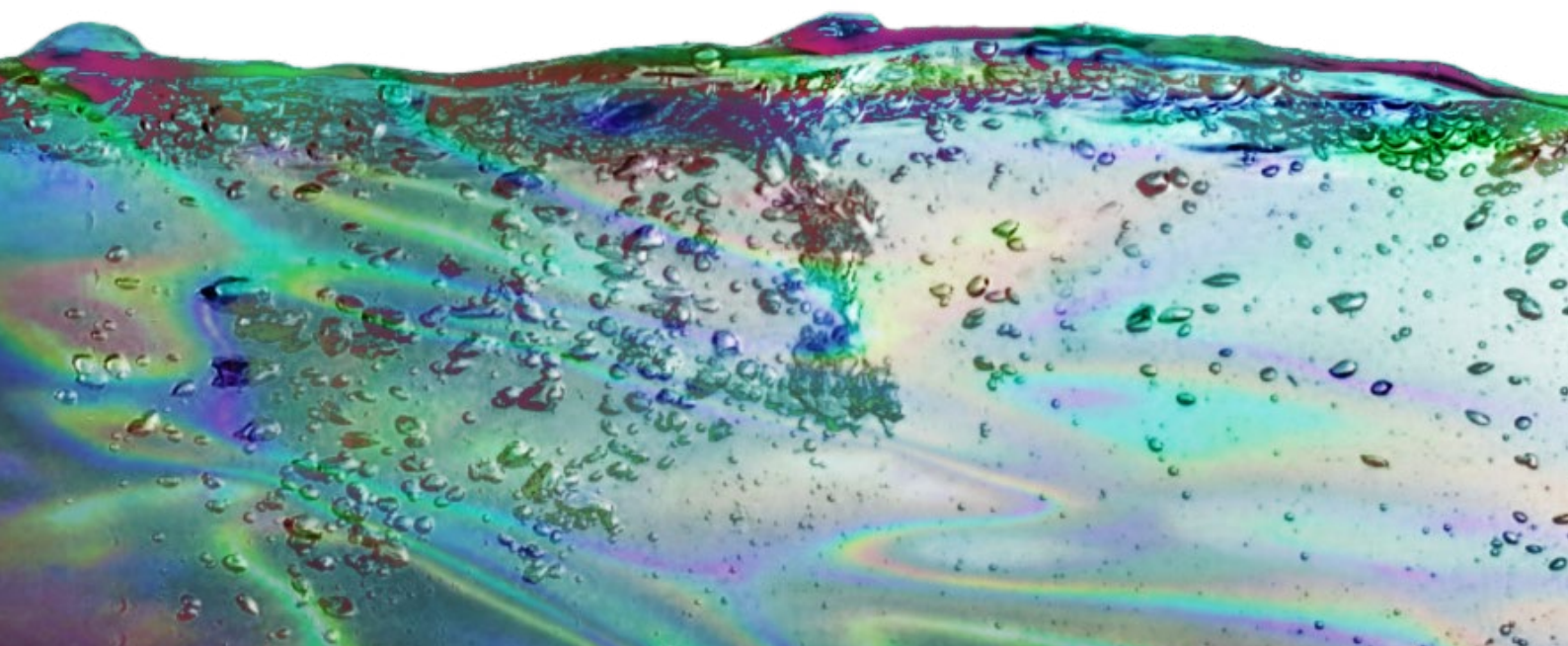

### MF-1036

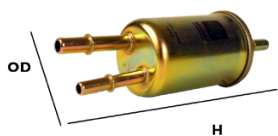

**H** = 180 mm  
**OD** = 57 mm  
**IN** = 9.5 mm  
**OUT** = 9.5 mm

CROSS REFERENCES		BRAND	MODEL	ENGINE	KW
FORD	2L2Z9155AB	FORD	EXPEDITION		
FORD	4L5Z9155AA	FORD	EXPLORER		
MAZDA	1F7013470A	FORD	EXPLORER SPORT TRAC		
FRAM	G9343	FORD	FOCUS		
INTERFIL	FGI207A	FORD	FREESTAR		
		FORD	RANGER		
		MAZDA	B-2300		
		MAZDA	B-3000		
		MAZDA	B-4000		

### MF-1051



**H** = 151 mm  
**OD** = 61 mm  
**IN** = 8 mm  
**OUT** = 8 mm

CROSS REFERENCES		BRAND	MODEL	ENGINE	KW
VW GROUP	6Q0201511	AUDI	A3		
VW GROUP	6Q0201511A	SEAT	CORDOBA		
FRAM	G9791	SEAT	IBIZA		
INTERFIL	FGI245				

### MF-1083

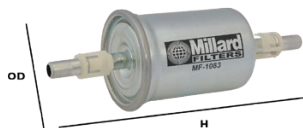

**H** = 176 mm  
**OD** = 58 mm  
**IN** = 9.5 mm  
**OUT** = 9.5 mm

CROSS REFERENCES		BRAND	MODEL	ENGINE	KW
FORD	2C5Z9155AA	FORD	EDGE		
FORD	2C5Z9155BC	FORD	EXPEDITION		
FRAM	G10166	FORD	EXPLORER		
		FORD	EXPLORER SPORT TRAC		
		FORD	F SERIES		
		FORD	F-450		
		FORD	F-550		
		FORD	LOBO		
		FORD	MUSTANG		
		FORD	THUNDERBIRD		

### MF-1582



**H** = 79 mm  
**OD** = 55 mm  
**IN** = 9.5 mm  
**OUT** = 8 mm

CROSS REFERENCES		BRAND	MODEL	ENGINE	KW
CHRYSLER	4897244AA	DODGE	NEON		
CHRYSLER	5278097	DODGE	STRATUS		
CHRYSLER	5278097AB				
GONHER	GG195				
INTERFIL	FGI138A				

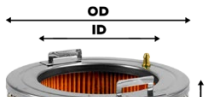
<b>MF-1680</b>	CROSS REFERENCES	BRAND	MODEL	ENGINE	KW		
	CHRYSLER	4864307	DODGE	DURANGO			
	INTERFIL	FGI53A	DODGE	RAM			
			DODGE	RAM 4000			

**H** = 44 mm  
**OD** = 127 mm  
**ID** = 83 mm

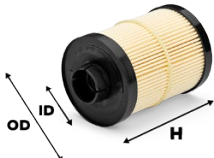
<b>MF-2000</b>	CROSS REFERENCES	BRAND	MODEL	ENGINE	KW		
	FIAT	71746975	FIAT	DUCATO			
	FIAT	77363600					
	FORD	1596790					
	FORD	9S519176AA					
	GM	93181377					
	GM	93193621					
	GM	96816473					
	FRAM	C10026					
	FRAM	C10026A					
INTERFIL	FGI280						

**H** = 100 mm  
**OD** = 68 mm  
**ID** = 12 mm

<b>MF-25248</b>	CROSS REFERENCES	BRAND	MODEL	ENGINE	KW		
	HYUNDAI	31911-05000	DODGE	ATOS			
	INTERFIL	FGI242					

**H** = 142 mm  
**OD** = 71 mm  
**IN** = M14x1.5  
**OUT** = 8 mm

<b>MF-283</b>	CROSS REFERENCES	BRAND	MODEL	ENGINE	KW		
	CHRYSLER	52100283AC	JEEP	CHEROKEE			
	INTERFIL	FGI214	JEEP	GRAND CHEROKEE			
			JEEP	RUBICON			

**H** = 170 mm  
**OD** = 54 mm  
**IN** = 8 mm  
**OUT** = 9.5 mm

### MF-29341



**H** = 178 mm  
**OD** = 95 mm  
**TH** = 7/8"-14

CROSS REFERENCES		BRAND	MODEL	ENGINE	KW
FRAM	P1121	CHEVROLET	KODIAK		
FRAM	P3380				
FRAM	P8451				

### MF-29882



**H** = 177 mm  
**OD** = 84 mm  
**TH** = 3/4"-16  
**DRAIN** = M36 x 1.5-6H

CROSS REFERENCES		BRAND	MODEL	ENGINE	KW
NISSAN	16403-06J60	NISSAN	D22 (FRONTIER)		
NISSAN	16405-01TOA	NISSAN	NP300		
NISSAN	16405-01T70	NISSAN	PICK-UP		
NISSAN	16405-V5710	NISSAN	URVAN		
FRAM	P5162				

### MF-3521

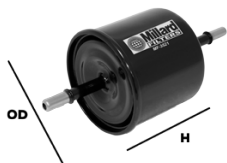

**H** = 174 mm  
**OD** = 82 mm  
**IN** = 8 mm  
**OUT** = 8 mm

CROSS REFERENCES		BRAND	MODEL	ENGINE	KW
FORD	98FU9155AA	FORD	CLUB WAGON		
FORD	FOTE9155AA	FORD	COURIER		
FORD	F2TA9A335BB	FORD	E SERIES (VANS)		
GM	25313817	FORD	ESCAPE		
GM	89028775	FORD	ESCAPE HYBRID		
MAZDA	ZZL013470	FORD	ESCORT		
MAZDA	ZZL013470	FORD	EXCURSION		
FRAM	G3850	FORD	EXPEDITION		
GONHER	GG1872	FORD	EXPLORER		
INTERFIL	FGI18	FORD	F SERIES		

### MF-3526



**H** = 146 mm  
**OD** = 79 mm  
**IN** = 8 mm  
**OUT** = 8 mm

CROSS REFERENCES		BRAND	MODEL	ENGINE	KW
FORD	7235007	FORD	FIESTA HATCHBACK		
FORD	92FB9155AA	FORD	IKON		
FORD	92FB9155BA				
GM	25067131				
MAZDA	1E0320490				
MAZDA	1E0420490				
MAZDA	1E0513490				
FRAM	G7099				
GONHER	GG82				
INTERFIL	FGI132				

### MF-3541



**H** = 120 mm  
**OD** = 71 mm  
**IN** = M14x1.5  
**OUT** = M12x1.25

CROSS REFERENCES		BRAND	MODEL	ENGINE	KW
HYUNDAI	31910-28300	mitsubishi	GALANT		
HYUNDAI	31910-28300AT	mitsubishi	MONTERO SPORT		
TOYOTA	23300-11150	TOYOTA	SOLARA		
TOYOTA	23300-11160				
TOYOTA	23300-11190				
TOYOTA	23300-16330				
FRAM	G6462				
FRAM	G7194				
INTERFIL	FGI40				
INTERFIL	FGI49				

### MF-3744



**H** = 151 mm  
**OD** = 84 mm  
**IN** = M14x1.5  
**OUT** = M12x1.5

CROSS REFERENCES		BRAND	MODEL	ENGINE	KW
FIAT	82425329	SEAT	TOLEDO		
FORD	82GB9155AA				
GM	25067058				
VW GROUP	443133511				
VW GROUP	811133511				
FRAM	G3744				
FRAM	G3745				
FRAM	G6398				
INTERFIL	FGI104				
INTERFIL	FGI95				

### MF-3747



**H** = 128 mm  
**OD** = 80 mm  
**IN** = M14x1.5  
**OUT** = M12x1.5

CROSS REFERENCES		BRAND	MODEL	ENGINE	KW
FIAT	71736110	AUDI	A4		
GM	25055428	AUDI	A6		
VW GROUP	431 133 511D	AUDI	A8		
VW GROUP	441 201 511B	AUDI	ALLROAD		
VW GROUP	441 201 511C	AUDI	QUATTRO		
VW GROUP	441 204 511C	AUDI	S4		
VW GROUP	8A0 133 511	AUDI	S6		
FRAM	G3747	AUDI	S8		
GONHER	GG246	VOLKSWAGEN	GOLF		
INTERFIL	FGI86	VOLKSWAGEN	PASSAT		

### MF-4132



**H** = 100 mm  
**OD** = 64 mm  
**IN** = M14x1.5  
**OUT** = M12x1.25

CROSS REFERENCES		BRAND	MODEL	ENGINE	KW
GM	25313811	mitsubishi	MIRAGE		
mitsubishi	MR204132				
TOYOTA	23300-74260				
TOYOTA	23300-79495				
FRAM	G8075				
GONHER	GG164				
INTERFIL	FGI151				



<b>MF-41570</b>	CROSS REFERENCES		BRAND	MODEL	ENGINE	KW			
-----------------	------------------	--	-------	-------	--------	----	--	--	--

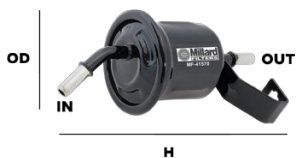

**H** = 154 mm  
**OD** = 65 mm  
**IN** = 8 mm  
**OUT** = 8 mm

TOYOTA	23300-75140	TOYOTA	HILUX						
--------	-------------	--------	-------	--	--	--	--	--	--

<b>MF-4777</b>	CROSS REFERENCES		BRAND	MODEL	ENGINE	KW			
----------------	------------------	--	-------	-------	--------	----	--	--	--

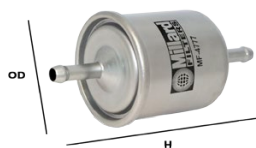

**H** = 124 mm  
**OD** = 59 mm  
**IN** = 8 mm  
**OUT** = 8 mm

FORD	YL4J9155AA	NISSAN	240SX						
GM	25121600	NISSAN	FRONTIER						
NISSAN	16400-9F928	NISSAN	MAXIMA						
NISSAN	16400-D0300	NISSAN	PATHFINDER						
FRAM	G4777	NISSAN	QUEST						
GONHER	GG63	NISSAN	URVAN						
INTERFIL	FGI1027	NISSAN	X-TERRA						
INTERFIL	FGI27								
INTERFIL	FGI27A								

<b>MF-481</b>	CROSS REFERENCES		BRAND	MODEL	ENGINE	KW			
---------------	------------------	--	-------	-------	--------	----	--	--	--



**H** = 110 mm  
**OD** = 59 mm  
**IN** = M16x1.5  
**OUT** = M16x1.5

GM	25055046	CHEVROLET							
GM	25055052								
GM	26055129								
GM	89028786								
GM	93429346								
FRAM	G3727								
FRAM	G3727DP								
GONHER	GG46								
INTERFIL	FGI19								
INTERFIL	FGI1919								

<b>MF-4886</b>	CROSS REFERENCES		BRAND	MODEL	ENGINE	KW			
----------------	------------------	--	-------	-------	--------	----	--	--	--



**H** = 138 mm  
**OD** = 96 mm  
**TH** = M20x1.5  
**DRAIN** = M36 x 1.5

FORD	5025102	DODGE	H100						
GM	93156634	DODGE	H100 VAN						
HYUNDAI	31970-44000	MITSUBISHI	L200						
KIA	OK467-23570								
MAZDA	145623570A								
MITSUBISHI	MB220900								
FRAM	P4886								
FRAM	PS10396								
FRAM	PS4886								
INTERFIL	FGI100								

<b>MF-4922</b>	CROSS REFERENCES		BRAND	MODEL	ENGINE	KW
<p><b>H</b> = 138 mm  <b>OD</b> = 93 mm  <b>TH</b> = 3/4"-16  <b>DRAIN</b> = M36 x 1.5-6H</p>	FORD	XM349150AA	FORD	RANGER		
	FORD	XM349159EA	MAZDA	B-2300		
	MAZDA	R2N513ZA5A	MAZDA	B-2500		
	NISSAN	16403-2SA00	MAZDA	B-3000		
	TOYOTA	23303-64010	MAZDA	B-4000		
	TOYOTA	23390-24480				
	VW GROUP	J23 303 64010				
	FRAM	P4922				
	FRAM	PS4922				
	INTERFIL	FGI101				

<b>MF-5030</b>	CROSS REFERENCES		BRAND	MODEL	ENGINE	KW
<p><b>H</b> = 165 mm  <b>OD</b> = 81 mm  <b>IN</b> = 8 mm  <b>OUT</b> = 8 mm</p>	FIAT	77110590	AUDI	A3		
	FORD	95VW6714AA	AUDI	A4		
	GM	25055495	AUDI	A6		
	NISSAN	16400-70J00	AUDI	ALLROAD		
	VW GROUP	1H0 201 511A	AUDI	QUATTRO		
	FRAM	G3829	SEAT	ALHAMBRA		
	FRAM	G5773	VOLKSWAGEN	CABRIO		
	GONHER	GC251	VOLKSWAGEN	EUROVAN		
	INTERFIL	FGI28	VOLKSWAGEN	PASSAT		
	INTERFIL	FGI28A	VOLKSWAGEN	SHARAN		

<b>MF-5138</b>	CROSS REFERENCES		BRAND	MODEL	ENGINE	KW
<p><b>H</b> = 139 mm  <b>OD</b> = 95 mm  <b>TH</b> = 3/4"-16  <b>DRAIN</b> = M36 x 1.5-6H</p>	FORD	YL4J9155BA	NISSAN	L200		
	NISSAN	16103-G9900	NISSAN	D22 (FRONTIER)		
	NISSAN	16400-VB201	NISSAN	NP300		
	NISSAN	16400-VC100	NISSAN	PICK-UP		
	NISSAN	16403-59EOA	NISSAN	URVAN		
	NISSAN	16403-G2400				
	NISSAN	16403-G9900				
	NISSAN	16403-G990A				
	FRAM	P5138				
	FRAM	P5226				

<b>MF-52021</b>	CROSS REFERENCES		BRAND	MODEL	ENGINE	KW
<p><b>H</b> = 141 mm  <b>OD</b> = 83 mm  <b>ID1</b> = 38 mm  <b>ID2</b> = 38 mm</p>	VW GROUP	1K0 127 177	AUDI	A3		
	VW GROUP	1K0 127 177A	AUDI	TT		
	VW GROUP	1K0 127 434	AUDI	TT-RS		
	VW GROUP	1K0 127 434A	AUDI	TTS		
	FRAM	C9766	VOLKSWAGEN	BORA		
	FRAM	C9766ECO	VOLKSWAGEN	CC		
	GONHER	G434	VOLKSWAGEN	GOLF		
	INTERFIL	FGI300D	VOLKSWAGEN	JETTA		
			VOLKSWAGEN	PASSAT		
			VOLKSWAGEN	TIGUAN		

<b>MF-5237</b>	<b>CROSS REFERENCES</b>		<b>BRAND</b>	<b>MODEL</b>	<b>ENGINE</b>	<b>KW</b>		
 <p><b>H</b> = 121 mm <b>OD</b> = 64 mm <b>IN</b> = 8 mm <b>OUT</b> = 8 mm</p>	GM	25175557	NISSAN	ALMERA				
	GM	89028779	NISSAN	ALTIMA				
	NISSAN	16400-10Y00	NISSAN	LUCINO				
	NISSAN	16400-72L00	NISSAN	PICK-UP				
	NISSAN	16400-72L10	NISSAN	SENTRA				
	FRAM	G5237	NISSAN	TIIDA				
	GONHER	GG137	NISSAN	TSURU				
	INTERFIL	FGI112						
	INTERFIL	FGI37						
	INTERFIL	FGI37A						

<b>MF-5738</b>	<b>CROSS REFERENCES</b>		<b>BRAND</b>	<b>MODEL</b>	<b>ENGINE</b>	<b>KW</b>		
 <p><b>H</b> = 178 mm <b>OD</b> = 82 mm <b>IN</b> = 9.5 mm <b>OUT</b> = 9.5 mm</p>	VW GROUP	337 133 511A	VOLKSWAGEN	CROSSFOX				
	VW GROUP	377 133 511A	VOLKSWAGEN	LUPO				
	VW GROUP	5X0 201 511	VOLKSWAGEN	POINTER				
	FRAM	G5738	VOLKSWAGEN	POINTER PICK-UP				
	GONHER	GG252						
	INTERFIL	FGI136						
	INTERFIL	FGI136A						

<b>MF-578</b>	<b>CROSS REFERENCES</b>		<b>BRAND</b>	<b>MODEL</b>	<b>ENGINE</b>	<b>KW</b>		
 <p><b>H</b> = 134 mm <b>OD</b> = 59 mm <b>IN</b> = 9.5 mm <b>OUT</b> = M16x1.5</p>	GM	25121293	CHEVROLET	CUTLASS				
	GM	25121449	CHEVROLET	EXPRESS VAN				
	GM	89028788	CHEVROLET	G SERIES				
	FRAM	G7315	CHEVROLET	IMPALA				
	GONHER	GG66	CHEVROLET	KODIAK C4500				
	INTERFIL	FGI26	CHEVROLET	KODIAK C5500				
	INTERFIL	FGI26A	CHEVROLET	LUMINA				
			CHEVROLET	MALIBU				
			CHEVROLET	MONTECARLO				
			CHEVROLET	S10				

<b>MF-580</b>	<b>CROSS REFERENCES</b>		<b>BRAND</b>	<b>MODEL</b>	<b>ENGINE</b>	<b>KW</b>		
 <p><b>H</b> = 171 mm <b>OD</b> = 59 mm <b>IN</b> = 9.5 mm <b>OUT</b> = 9.5 mm</p>	GM	25121466	CHEVROLET	COLORADO				
	GM	25121468	CHEVROLET	EXPRESS VAN				
	GM	89028790	CHEVROLET	G SERIES				
	FRAM	G7333						
	INTERFIL	FGI115						
	INTERFIL	FGI115A						

<b>MF-5857</b>	CROSS REFERENCES		BRAND	MODEL	ENGINE	KW			
 <p> <b>H</b> = 139 mm  <b>OD</b> = 60 mm  <b>IN</b> = 8 mm  <b>OUT</b> = 8 mm         </p>	FIAT	9622617880	NISSAN	APRIO					
	GM	91159804	NISSAN	PLATINA					
	GM	91559804	VOLKSWAGEN	GOL					
	NISSAN	16400-00QAA	VOLKSWAGEN	SAVEIRO					
	NISSAN	16400-JD51A							
	FRAM	G10230							
	FRAM	G5857							
	GONHER	GC291							
	GONHER	GC312							
	INTERFIL	FGI062							

<b>MF-5870</b>	CROSS REFERENCES		BRAND	MODEL	ENGINE	KW			
 <p> <b>H</b> = 168 mm  <b>OD</b> = 80 mm  <b>IN</b> = 8 mm  <b>OUT</b> = 8 mm         </p>	VW GROUP	1JO 201 511A	AUDI						
	VW GROUP	1JO 201 511A	SEAT						
	FRAM	G5870	VOLKSWAGEN						
	GONHER	GG102							
	INTERFIL	FGI105							
	INTERFIL	FGI105A							

<b>MF-5982</b>	CROSS REFERENCES		BRAND	MODEL	ENGINE	KW			
 <p> <b>H</b> = 134 mm  <b>OD</b> = 70 mm  <b>IN</b> = 8 mm  <b>OUT</b> = 8 mm         </p>	GM	30020673	CHEVROLET	TRACKER					
	FRAM	G5982							
	INTERFIL	FGI194							
	INTERFIL	FGI261							

<b>MF-618</b>	CROSS REFERENCES		BRAND	MODEL	ENGINE	KW			
 <p> <b>H</b> = 163 mm  <b>OD</b> = 59 mm  <b>IN</b> = 8 mm  <b>OUT</b> = 8 mm         </p>	FIAT	46403932	CHEVROLET						
	GM	25121074	FIAT						
	VW GROUP	6X0 201 511	VOLKSWAGEN						
	VW GROUP	6X0 201 511B							
	FRAM	G5540							
	FRAM	G5978							
	FRAM	G5995							
	GONHER	GG64							
	INTERFIL	FGI1012							
	INTERFIL	FGI12							

### MF-619



**H** = 163 mm  
**OD** = 60 mm  
**IN** = 8 mm  
**OUT** = 8 mm

CROSS REFERENCES		BRAND	MODEL	ENGINE	KW		
GM	96335719	CHEVROLET	AVEO (MEXICO)				
INTERFIL	FGI227	CHEVROLET	MATIZ				
		CHEVROLET	OPTRA				

### MF-6397

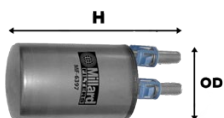

**H** = 118 mm  
**OD** = 55 mm  
**IN** = 9.5 mm  
**OUT** = 9.5 mm

CROSS REFERENCES		BRAND	MODEL	ENGINE	KW		
GM	15015509	CHEVROLET	BLAZER				
GM	88983068	CHEVROLET	SSR				
FRAM	G9344	CHEVROLET	TRAIL BLAZER				
INTERFIL	FGI206A						

### MF-6400



**H** = 137 mm  
**OD** = 60 mm  
**IN** = 8 mm  
**OUT** = 8 mm

CROSS REFERENCES		BRAND	MODEL	ENGINE	KW		
FIAT	71711048	AUDI	RS6				
FORD	5010912						
FORD	A780X9155AA						
GM	90169150						
VW GROUP	6N0201211						
FRAM	G6400						
FRAM	G7393						
FRAM	G9716						
INTERFIL	FGI0168						
INTERFIL	FGI141						

### MF-645A



**H** = 138 mm  
**OD** = 55 mm  
**IN** = M16x1.5  
**OUT** = 9.5 mm

CROSS REFERENCES		BRAND	MODEL	ENGINE	KW		
GM	25168251	CHEVROLET	AVALANCHE				
GM	25168594	CHEVROLET	BLAZER				
GM	89028789	CHEVROLET	S10				
FRAM	G8219	CHEVROLET	SILVERADO				
INTERFIL	FGI137	CHEVROLET	SUBURBAN				
INTERFIL	FGI137A	CHEVROLET	TAHOE				

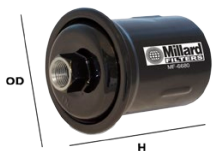
<b>MF-6680</b>	CROSS REFERENCES	BRAND	MODEL	ENGINE	KW
 <p><b>H</b> = 109 mm <b>OD</b> = 71 mm <b>IN</b> = M14x1.5 <b>OUT</b> = M14x1.5</p>	GM	25175534	DODGE	VAN 1000	
	HYUNDAI	31911-34000	HYUNDAI	SONATA	
	HYUNDAI	31911-34000AT	HYUNDAI	XG300	
	TOYOTA	23300-34000	KIA	MAGENTIS (CANADA)	
	TOYOTA	23300-50020	KIA	OPTIMA	
	TOYOTA	23300-65010	TOYOTA	4RUNNER	
	FRAM	G6680	TOYOTA	TUNDRA	
	FRAM	G6825			
	GONHER	GG187			
	INTERFIL	FGI50			

<b>MF-6826</b>	CROSS REFERENCES	BRAND	MODEL	ENGINE	KW
 <p><b>H</b> = 94 mm <b>OD</b> = 85 mm <b>IN</b> = M14x1.5 <b>OUT</b> = M12x1.25</p>	GM	25176275	HONDA	ACCORD	
	HONDA	16010SM4315			
	HONDA	16010SM4506			
	HONDA	16010SM4931			
	HONDA	16010SM4932			
	FRAM	G5659			
	FRAM	G6826			
	GONHER	GG161			
	GONHER	GG184			
	INTERFIL	FGI45			

<b>MF-7196</b>	CROSS REFERENCES	BRAND	MODEL	ENGINE	KW
 <p><b>H</b> = 125 mm <b>OD</b> = 71 mm <b>IN</b> = M12x1.25 <b>OUT</b> = M12x1.25</p>	FRAM	G7196	MITSUBISHI	3000	
	INTERFIL	FGI220	TOYOTA	4RUNNER	
	INTERFIL	FGI90			

<b>MF-73138</b>	CROSS REFERENCES	BRAND	MODEL	ENGINE	KW
 <p><b>H</b> = 128 mm <b>OD</b> = 91 mm <b>IN</b> = 10 mm <b>OUT</b> = 8 mm</p>	CHRYSLER	05117492AA	JEEP	GRAND CHEROKEE	
	CHRYSLER	05175429AB			
	FIAT	K05117492AA			
	FIAT	K05175429AB			
	FRAM	P10148			
	INTERFIL	FGI278D			

<b>MF-7404</b>	CROSS REFERENCES		BRAND	MODEL	ENGINE	KW		
 <p> <b>H</b> = 128 mm  <b>OD</b> = 82 mm  <b>IN</b> = 8 mm  <b>OUT</b> = 8 mm                 </p>	FORD	F3XY9155A	NISSAN	QUEST				
	GM	25176294						
	GM	25176295						
	MAZDA	FS5620490A						
	NISSAN	16400-0B000						
	NISSAN	16400-N8601						
	FRAM	G4194						
	FRAM	G7404						
	GONHER	GG94						
	INTERFIL	FGI47						

<b>MF-74058</b>	CROSS REFERENCES		BRAND	MODEL	ENGINE	KW		
 <p> <b>H</b> = 90 mm  <b>OD</b> = 53 mm  <b>IN</b> = 9.5 mm  <b>OUT</b> = 8 mm                 </p>	CHRYSLER	52100402AE	JEEP	LIBERTY				
	CHRYSLER	52100402AF						
	FRAM	G8897						
	INTERFIL	FGI235						

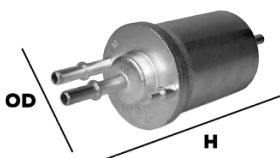
<b>MF-74120</b>	CROSS REFERENCES		BRAND	MODEL	ENGINE	KW		
 <p> <b>H</b> = 164 mm  <b>OD</b> = 61 mm  <b>IN</b> = 8 mm  <b>OUT</b> = 8 mm                 </p>	VW GROUP	1K0 201 051K	AUDI					
	VW GROUP	6Q0 201 051	SEAT					
	VW GROUP	6Q0 201 051B	VOLKSWAGEN					
	VW GROUP	6Q0 201 051H						
	VW GROUP	6Q0 201 051J						
	VW GROUP	6Q0 201 512						
	FRAM	G10146						
	FRAM	G10147						
	GONHER	GG107						
	INTERFIL	FGI325						

<b>MF-75110</b>	CROSS REFERENCES		BRAND	MODEL	ENGINE	KW		
 <p> <b>H</b> = 118 mm  <b>OD</b> = 66 mm  <b>IN</b> = M14x1.5  <b>OUT</b> = 8 mm                 </p>	TOYOTA	23300-74300	TOYOTA	HILUX				
	TOYOTA	23300-74310						
	TOYOTA	23300-75010						
	TOYOTA	23300-75110						
	TOYOTA	23300-79255						
	INTERFIL	FGI160						

<b>MF-7599</b>	CROSS REFERENCES	BRAND	MODEL	ENGINE	KW	
 <p><b>H</b> = 114 mm  <b>OD</b> = 75 mm  <b>IN</b> = M12x1.25  <b>OUT</b> = M14x1.5</p>	GM	25176324	HONDA	ACCORD		
	HONDA	16010S01A30	HONDA	CR-V		
	HONDA	16010S01A31	HONDA	ODYSSEY		
	HONDA	16010S01A32	HONDA	PRELUDE		
	HONDA	16010ST5931				
	HONDA	16010ST5933				
	HONDA	16010ST5E01				
	FRAM	G7599				
	GONHER	GG160				
	INTERFIL	FGI52				

<b>MF-800</b>	CROSS REFERENCES	BRAND	MODEL	ENGINE	KW	
 <p><b>H</b> = 138 mm  <b>OD</b> = 82 mm  <b>IN</b> = 8 mm  <b>OUT</b> = 8 mm</p>	FORD	E35E9155CZA	FORD	ESCAPE		
	FORD	E3EE9155C2C	FORD	ESCAPE HYBRID		
	FORD	E83C9B072AA	MAZDA	TRIBUTE		
	GM	25055302	MAZDA	TRIBUTE HYBRID		
	MAZDA	ZZMO13470				
	VW GROUP	811 133 511A				
	FRAM	G3802				
	FRAM	G3802A				
	GONHER	GG47				
	INTERFIL	FGI11				

<b>MF-9000</b>	CROSS REFERENCES	BRAND	MODEL	ENGINE	KW	
 <p><b>H</b> = 110 mm  <b>OD</b> = 70 mm  <b>IN</b> = M14x1.5  <b>OUT</b> = M12x1.5</p>	GM	25313807	HYUNDAI	ELANTRA		
	HYUNDAI	31911-29000	HYUNDAI	TIBURON		
	FRAM	G8160				

<b>MF-90122</b>	CROSS REFERENCES	BRAND	MODEL	ENGINE	KW	
 <p><b>H</b> = 122 mm  <b>OD</b> = 65 mm  <b>IN</b> = 8 mm  <b>OUT</b> = 8 mm</p>	HYUNDAI	31911-25000	DODGE	VERNA		
	HYUNDAI	31940-00000				
	HYUNDAI	31940-25000				
	FRAM	G11140				
	INTERFIL	FGI222				



## MF-9145



**H** = 120 mm

**OD** = 71 mm

**IN** = M14x1.5

**OUT** = M12x1.25

CROSS REFERENCES		BRAND	MODEL	ENGINE	KW
GM	25121757	CHEVROLET	PRIZM		
GM	94847597				
MAZDA	FE6513480				
TOYOTA	2330019145				
TOYOTA	2330079105				
FRAM	G6674				
FRAM	G7612				
GONHER	GG213				
INTERFIL	FG184				

## MF-986

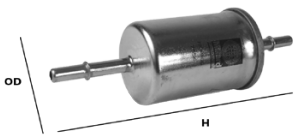

**H** = 180 mm

**OD** = 56 mm

**IN** = 8 mm

**OUT** = 8 mm

CROSS REFERENCES		BRAND	MODEL	ENGINE	KW
FORD	2M5Z9155CA	CHEVROLET			
FORD	5L1Z9155AA	FORD			
FORD	F89E9155AA	MAZDA			
FORD	F89Z9155A				
FORD	XF5Z9155BA				
MAZDA	ZZP013470				
FRAM	G8018				
GONHER	GC986				
INTERFIL	FG1018				
INTERFIL	FG1133				





# FILTROS DE ACEITE

---

El aceite reduce el desgaste, refrigera los componentes y protege el motor contra la corrosión. La tecnología Millard® cuida el motor de los agentes contaminantes resultantes de la combustión, polvo y partículas abrasivas que pueden crear desgaste en el motor, al mismo tiempo que mantiene la viscosidad correcta cumpliendo con los niveles exigidos por el fabricante original.

## ML-10060

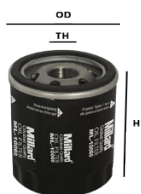

**H** = 86 mm  
**OD** = 76 mm  
**TH** = M22x1.5  
**BY PASS** = Y

CROSS REFERENCES		BRAND	MODEL	ENGINE	KW	
FIAT	9808867880	CHEVROLET				
FORD	AA5Z6714A	CHRYSLER				
FORD	BK2Q6714AA	DODGE				
GM	89017524	FIAT				
FRAM	PH10060	FORD				
GONHER	GP405	HONDA				
GONHER	GP406	JEEP				
INTERFIL	OF10060	MAZDA				
INTERFIL	OF10575	MITSUBISHI				
INTERFIL	OF2Q67	VOLKSWAGEN				

## ML-12027

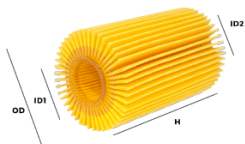

**H** = 117 mm  
**OD** = 70 mm  
**ID1** = 28 mm  
**ID2** = 28 mm

CROSS REFERENCES		BRAND	MODEL	ENGINE	KW	
TOYOTA	04152-YZZA4	TOYOTA	LAND CRUISER			
TOYOTA	41523-8020	TOYOTA	SEQUOIA			
TOYOTA	41525-1010	TOYOTA	TUNDRA			
FRAM	CH10295					
INTERFIL	OF10295					

## ML-13



**H** = 132 mm  
**OD** = 93 mm  
**TH** = 13/16"-16

CROSS REFERENCES		BRAND	MODEL	ENGINE	KW	
FORD	1498027	CHEVROLET	400 SS			
FORD	5000188	CHEVROLET	CHEYENNE			
GM	5578052	CHEVROLET	EXPRESS VAN			
GM	6435679	CHEVROLET	G SERIES			
FRAM	PH13	CHEVROLET	SILVERADO			
FRAM	PH14	CHEVROLET	SONORA			
FRAM	PH25	CHEVROLET	TAHOE			
GONHER	GPI3					
INTERFIL	OF13					
INTERFIL	OF5					

## ML-14120

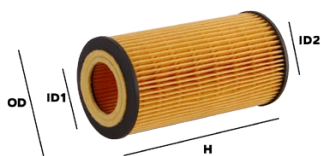

**H** = 125 mm  
**OD** = 64 mm  
**ID1** = 30 mm  
**ID2** = 30 mm

CROSS REFERENCES		BRAND	MODEL	ENGINE	KW	
FORD	6G9N6744BA	AUDI				
VW GROUP	06D 115 466	SEAT				
VW GROUP	06D 115 562	VOLKSWAGEN				
FRAM	CH9496					
FRAM	CH9496ECO					
FRAM	CH9911					
FRAM	CH9954					
GONHER	G313					
INTERFIL	OF5562					
INTERFIL	OF9954					

## ML-16



**H** = 97 mm  
**OD** = 95 mm  
**TH** = 3/4"-16  
**BY PASS** = Y

CROSS REFERENCES		BRAND	MODEL	ENGINE	KW
CHRYSLER	2650396	AUDI	A4		
FIAT	60507080	AUDI	A6		
FORD	OHM6716BA	AUDI	ALLROAD		
GM	7961367	AUDI	QUATTRO		
NISSAN	15208-BN300	AUDI	S4		
TOYOTA	15601-25010	NISSAN	CABSTAR		
VW GROUP	021 115 351A	NISSAN	NV350 URVAN		
FRAM	PH16	VOLKSWAGEN	PASSAT		
INTERFIL	OF1520				
INTERFIL	OF16				

## ML-19626

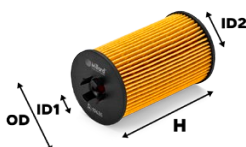

**H** = 105 mm  
**OD** = 57 mm  
**ID1** = 22 mm  
**ID2** = 10 mm

CROSS REFERENCES		BRAND	MODEL	ENGINE	KW
CHEVROLET	55353324	CHEVROLET	ASTRA		
FIAT	71744410	CHEVROLET	AVEO (USA)		
GM	55353324	CHEVROLET	CRUZE		
GM	55594651	CHEVROLET	SONIC		
GM	93185674	CHEVROLET	TRAX		
FRAM	CH10246				
FRAM	CH10246ECO				
INTERFIL	OF10246				

## ML-2

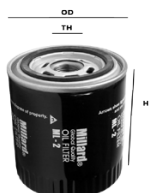

**H** = 106 mm  
**OD** = 93 mm  
**TH** = M22x1.5  
**BY PASS** = Y

CROSS REFERENCES		BRAND	MODEL	ENGINE	KW
FORD	3W7E6714AA	CHRYSLER			
FORD	F1AE6714BC	DODGE			
FORD	XW4E6714BA	FORD			
FORD	XW4E6714DA	JEEP			
MAZDA	AJ0414302	MAZDA			
MAZDA	AJ0414302B	MITSUBISHI			
FRAM	PH2				
GONHER	GP68				
INTERFIL	OF2				
INTERFIL	OF6714				

## ML-20004



**H** = 100 mm  
**OD** = 77 mm  
**TH** = 3/4"-16  
**BY PASS** = Y

CROSS REFERENCES		BRAND	MODEL	ENGINE	KW
FIAT	59030255	TOYOTA	4RUNNER		
MAZDA	1E0514302	TOYOTA	FJ CRUISER		
NISSAN	AY100-TY015	TOYOTA	HIACE		
TOYOTA	90915-03005	TOYOTA	HIGHLANDER		
TOYOTA	90915-YZZD3	TOYOTA	HIGHLANDER HYBRID		
VW GROUP	J90 915 200 01	TOYOTA	HILUX		
FRAM	PH4985	TOYOTA	LAND CRUISER		
		TOYOTA	SIENNA		
		TOYOTA	TACOMA		
		TOYOTA	TUNDRA		

## ML-2849



**H** = 121 mm  
**OD** = 82 mm  
**TH** = M20x1.5  
**BY PASS** = Y

CROSS REFERENCES		BRAND	MODEL	ENGINE	KW	
FRAM	PH2849A	FIAT	PALIO ADVENTURE			
GONHER	GP24	FIAT	PALIO SEDAN			
		FIAT	STILO SCHUMACHER			

## ML-321

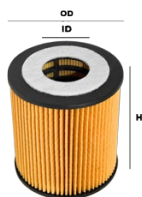

**H** = 73 mm  
**OD** = 65 mm  
**ID1** = 27 mm  
**ID2** = 27 mm

CROSS REFERENCES		BRAND	MODEL	ENGINE	KW	
FORD	1S7J6744AC	FORD	ESCAPE			
MAZDA	L32114302	FORD	ESCAPE HYBRID			
MAZDA	L321143029A	FORD	FUSION			
MAZDA	LF0114302	MAZDA	CX-7			
MAZDA	LF01143029A	MAZDA	MAZDA 3, 5, 6			
VW GROUP	03P 115 562	MAZDA	MAZDASPEED			
FRAM	CH9382	MAZDA	MIATA			
FRAM	CH9382ECO	MAZDA	MX-5			
FRAM	CH9641	MAZDA	TRIBUTE			
INTERFIL	OF9641	MAZDA	TRIBUTE HYBRID			

## ML-3387



**H** = 87 mm  
**OD** = 79 mm  
**TH** = M18x1.5

CROSS REFERENCES		BRAND	MODEL	ENGINE	KW	
FORD	5000277	CHEVROLET				
FORD	5002453	FIAT				
FORD	A760X6714JA					
GM	92142003					
TOYOTA	15611U316071					
TOYOTA	156153172071					
FRAM	PH3387					
FRAM	PH3387A					
GONHER	GP46					
INTERFIL	OF3387					

## ML-3593



**H** = 86 mm  
**OD** = 72 mm  
**TH** = M20x1.5  
**BY PASS** = Y

CROSS REFERENCES		BRAND	MODEL	ENGINE	KW	
FIAT	46751179	CHEVROLET				
FORD	KL0714302B	CHRYSLER				
GM	90485456	DODGE				
HONDA	15400PLC003	FIAT				
HYUNDAI	S2630-035A00	HONDA				
NISSAN	15208-65F0A	HYUNDAI				
FRAM	PH3807	KIA				
GONHER	GP320	MITSUBISHI				
INTERFIL	OF2500	NISSAN				
INTERFIL	OF7317					

## ML-3600



**H** = 121 mm  
**OD** = 76 mm  
**TH** = 3/4"-16  
**BY PASS** = Y

CROSS REFERENCES		BRAND	MODEL	ENGINE	KW	
CHRYSLER	04781452AB	CHRYSLER				
FIAT	K04781452AB	DODGE				
FORD	1S7Z6731DA	FORD				
NISSAN	15208-13210	JEEP				
VW GROUP	701 155 61	MAZDA				
FRAM	PH2991	MITSUBISHI				
FRAM	PH5803	TOYOTA				
GONHER	GP3600					
INTERFIL	OF3600					
INTERFIL	OF8316					

## ML-3614



**H** = 87 mm  
**OD** = 78 mm  
**TH** = 3/4"-16  
**BY PASS** = Y

CROSS REFERENCES		BRAND	MODEL	ENGINE	KW	
FIAT	K04105409AB	AUDI				
FORD	77BM6714C1A	CHEVROLET	TRACKER			
GM	93156186	CHRYSLER				
NISSAN	31725-L1000	DODGE				
TOYOTA	15601-13010	FORD				
VW GROUP	047 115 561B	JEEP				
FRAM	PH3614	MAZDA				
GONHER	GP58	MITSUBISHI				
INTERFIL	OF3614	TOYOTA				
INTERFIL	OF9566	VOLKSWAGEN				

## ML-3675



**H** = 115 mm  
**OD** = 78 mm  
**TH** = 13/16"-16

CROSS REFERENCES		BRAND	MODEL	ENGINE	KW	
GM	25014377	CHEVROLET				
GM	25014748					
GM	92068246					
GM	D92068246					
FRAM	PH3429					
FRAM	PH3675					
FRAM	PH9837					
INTERFIL	OF3675					

## ML-3682



**H** = 100 mm  
**OD** = 83 mm  
**TH** = 3/4"-16

CROSS REFERENCES		BRAND	MODEL	ENGINE	KW	
FIAT	43944630	NISSAN	QUEST			
FIAT	60810709					
FORD	YL4J6714AA					
GM	93156668					
NISSAN	15208-13201					
FRAM	PH2985					
FRAM	PH3682					
GONHER	GP3682					
GONHER	GP37					
INTERFIL	OF3682					

## ML-3976



**H** = 172 mm  
**OD** = 93 mm  
**TH** = 1"-16

CROSS REFERENCES		BRAND	MODEL	ENGINE	KW	
HYUNDAI	39086-15	DODGE	DURANGO			
FRAM	PH3900	DODGE	RAM			
FRAM	PH3976	DODGE	RAM 4000			
FRAM	PH3976A					
INTERFIL	OF3976					

## ML-42040



**H** = 124 mm  
**OD** = 96 mm  
**TH** = M26x1.5  
**BY PASS** = Y

CROSS REFERENCES		BRAND	MODEL	ENGINE	KW	
GM	97329911	DODGE	H100			
HYUNDAI	26300-42030	DODGE	H100 VAN			
HYUNDAI	26300-42040					
HYUNDAI	26300-42060					
HYUNDAI	26330-4X000					
KIA	26310-4A000					
KIA	26330-4X000					
FRAM	PH10127					
FRAM	PH10684					
INTERFIL	OF4240					

## ML-44155

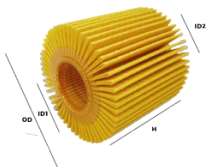

**H** = 67 mm  
**OD** = 69 mm  
**ID1** = 28 mm  
**ID2** = 28 mm

CROSS REFERENCES		BRAND	MODEL	ENGINE	KW	
TOYOTA	04152-YZZA1	TOYOTA	AVALON			
TOYOTA	04152-YZZA8	TOYOTA	AVALON HYBRID			
TOYOTA	15600-01010	TOYOTA	CAMRY			
TOYOTA	41523-1050	TOYOTA	CAMRY HYBRID			
TOYOTA	41523-1090	TOYOTA	HIGHLANDER			
TOYOTA	41523-1090	TOYOTA	HIGHLANDER HYBRID			
TOYOTA	41523-1110	TOYOTA	RAV 4			
FRAM	CH9972	TOYOTA	RAV 4 HYBRID			
INTERFIL	OF9972	TOYOTA	TACOMA			
		TOYOTA	VENZA			

## ML-4847



**H** = 143 mm  
**OD** = 110 mm  
**TH** = 3/4"-16  
**BY PASS** = Y

CROSS REFERENCES		BRAND	MODEL	ENGINE	KW	
FIAT	71713782	CHEVROLET	CITY EXPRESS			
FIAT	71753740					
FIAT	98432651					
FORD	5025089					
GM	25067093					
GM	9110665					
FRAM	PH4847					
FRAM	PH4847A					
GONHER	GP9					
INTERFIL	OF43					

## ML-49



**H** = 261 mm  
**OD** = 109 mm  
**TH** = 1 1/8"-16  
**BY PASS** = Y

CROSS REFERENCES		BRAND	MODEL	ENGINE	KW	
FORD	5011417	CHEVROLET	KODIAK			
FORD	5011502					
GM	6439392					
NISSAN	15208Z9003					
FRAM	PH49A					
FRAM	PH5394					

## ML-4952

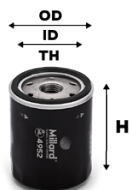

**H** = 94 mm  
**OD** = 78 mm  
**TH** = 13/16"-16  
**BY PASS** = Y

CROSS REFERENCES		BRAND	MODEL	ENGINE	KW	
FORD	5007165	CHEVROLET				
FORD	5020120					
GM	25010251					
GM	88984215					
GM	93156863					
GM	9975449					
FRAM	PH3506					
FRAM	PH4952					
FRAM	PH8830					
INTERFIL	OF3506					

## ML-4967



**H** = 72 mm  
**OD** = 68 mm  
**TH** = 3/4"-16  
**BY PASS** = Y

CROSS REFERENCES		BRAND	MODEL	ENGINE	KW	
GM	93156670	CHEVROLET	MATIZ			
GM	94840078	CHEVROLET	PRIZM			
TOYOTA	89220-2003	TOYOTA	AVANZA			
TOYOTA	89220-2005	TOYOTA	CELICA			
TOYOTA	90080-91045	TOYOTA	COROLLA			
TOYOTA	90080-91058	TOYOTA	MATRIX			
TOYOTA	90915-03001	TOYOTA	MATRIX HYBRID			
FRAM	PH4967	TOYOTA	MR2 SPYDER			
INTERFIL	OF2951	TOYOTA	PRIUS HYBRID			
INTERFIL	OF4967	TOYOTA	YARIS			

## ML-5166



**H** = 86 mm  
**OD** = 68 mm  
**TH** = 3/4"-16

CROSS REFERENCES		BRAND	MODEL	ENGINE	KW	
NISSAN	15208-53J00	CHEVROLET	TRACKER			
NISSAN	15208-70J00	NISSAN	MICRA			
NISSAN	15208-BX00A	TOYOTA	4RUNNER			
TOYOTA	90915-03004	TOYOTA	CAMRY			
TOYOTA	90915-10002	TOYOTA	CAMRY HYBRID			
FRAM	PH4386	TOYOTA	CELICA			
FRAM	PH5166	TOYOTA	COROLLA			
FRAM	PH9908	TOYOTA	HIGHLANDER			
INTERFIL	OF4386	TOYOTA	MATRIX			
INTERFIL	OF966	TOYOTA	RAV 4			



## ML-52149

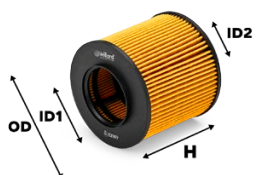

**H** = 73 mm  
**OD** = 66 mm  
**ID1** = 9 mm  
**ID2** = 33 mm

CROSS REFERENCES		BRAND	MODEL	ENGINE	KW
VW GROUP	03C115562	AUDI	A3		
VW GROUP	03C115577A	SEAT	IBIZA		
FRAM	CH9706	SEAT	IBIZA DSG		
FRAM	CH9706ECO	SEAT	LEON		
GONHER	G562				
INTERFIL	OF3C11				

## ML-5548



**H** = 92 mm  
**OD** = 78 mm  
**TH** = 3/4"-16  
**BY PASS** = Y

CROSS REFERENCES		BRAND	MODEL	ENGINE	KW
VW GROUP	030 115 561A	SEAT	ALTEA		
VW GROUP	030 115 561AB	SEAT	CORDOBA		
VW GROUP	030 115 561AD	SEAT	LEON		
VW GROUP	030 115 561AN	VOLKSWAGEN	CROSSFOX		
VW GROUP	030 115 561T	VOLKSWAGEN	GOL		
FRAM	PH5548	VOLKSWAGEN	LUPO		
FRAM	PH5975	VOLKSWAGEN	POLO		
FRAM	PH8993	VOLKSWAGEN	SAVEIRO		
GONHER	GP428	VOLKSWAGEN	SPORT VAN		
INTERFIL	OF5548D				

## ML-5552



**H** = 121 mm  
**OD** = 78 mm  
**TH** = 3/4"-16  
**BY PASS** = Y

CROSS REFERENCES		BRAND	MODEL	ENGINE	KW
CHRYSLER	05003558AB	AUDI			
FIAT	46795125	FORD			
FORD	YN2G6714838	JEEP			
GM	90542344	MAZDA			
NISSAN	15208-V4000	SEAT			
VW GROUP	034 115 561A	VOLKSWAGEN			
FRAM	PH5552				
GONHER	GP28				
INTERFIL	OF2870				
INTERFIL	OF2870D				

## ML-5566



**H** = 87 mm  
**OD** = 78 mm  
**TH** = M20x1.5  
**BY PASS** = Y

CROSS REFERENCES		BRAND	MODEL	ENGINE	KW
CHEVROLET	96818899	HYUNDAI	IX35		
FIAT	9456000927				
FORD	4M5Q6714CA				
GM	93156562				
HYUNDAI	26300-21010				
NISSAN	15208-6F901				
TOYOTA	SU001-00453				
FRAM	PH5566				
GONHER	GP3985				
INTERFIL	OF11T0				

## ML-5796



**H** = 53 mm  
**OD** = 78 mm  
**TH** = M20x1.5  
**BY PASS** = Y

CROSS REFERENCES		BRAND	MODEL	ENGINE	KW
FIAT	46796687	NISSAN	APRIO		
FIAT	73500506	NISSAN	PLATINA		
GM	93181255				
GM	93198441				
MAZDA	AM1514302				
NISSAN	15208-00Q0F				
FRAM	PH5796				
FRAM	PH57961				
INTERFIL	OF4858				
INTERFIL	OF927				

## ML-5934

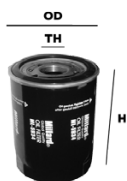

**H** = 166 mm  
**OD** = 122 mm  
**TH** = 1 1/2"-12  
**BY PASS** = Y

CROSS REFERENCES		BRAND	MODEL	ENGINE	KW
FRAM	PH5934	CHEVROLET	EXPRESS VAN		
GONHER	GP3980	CHEVROLET	S10		
INTERFIL	OF3980	CHEVROLET	SILVERADO		
		CHEVROLET	SUBURBAN		
		CHEVROLET	TAHOE		

## ML-6355



**H** = 138 mm  
**OD** = 104 mm  
**TH** = M26x1.5  
**BY PASS** = Y

CROSS REFERENCES		BRAND	MODEL	ENGINE	KW
HYUNDAI	26300-42000	MITSUBISHI	L200		
KIA	OVS01-14302				
MAZDA	VSY114302A				
MITSUBISHI	MD069782				
MITSUBISHI	MD069783				
NISSAN	15208-HA300				
TOYOTA	15601-78010				
FRAM	PH6355				
FRAM	PH8936				
GONHER	GP321				

## ML-64846



**H** = 140 mm  
**OD** = 78 mm  
**TH** = M27x1.5  
**BY PASS** = Y

CROSS REFERENCES		BRAND	MODEL	ENGINE	KW
VW GROUP	06H 115 403	AUDI			
VW GROUP	06H 115 561	SEAT			
VW GROUP	06J 115 403	VOLKSWAGEN			
VW GROUP	06J 115 403C				
VW GROUP	06J 115 403J				
VW GROUP	06J 115 403M				
VW GROUP	06J 115 403Q				
VW GROUP	06J 115 561B				
GONHER	GP407				
INTERFIL	OF5403				

## ML-6607



**H** = 67 mm  
**OD** = 70 mm  
**TH** = M20x1.5  
**BY PASS** = Y

CROSS REFERENCES		BRAND	MODEL	ENGINE	KW	
FORD	E9GZ6731A	CHEVROLET				
HONDA	15400PFB004	DODGE				
HYUNDAI	26300-02500	HONDA				
KIA	26300-02750	KIA				
MAZDA	8FG1238029A	MAZDA				
NISSAN	15208-65F00	NISSAN				
TOYOTA	15208-65F01	NISSAN				
FRAM	PH6607					
GONHER	GP91					
INTERFIL	OF6607					

## ML-8



**H** = 132 mm  
**OD** = 95 mm  
**TH** = 3/4"-16  
**BY PASS** = Y

CROSS REFERENCES		BRAND	MODEL	ENGINE	KW	
CHRYSLER	2458807	FORD	CLUB WAGON			
FIAT	4354828	FORD	EXPEDITION			
FORD	D1NN6714C	FORD	RANGER			
NISSAN	1520865601					
VW GROUP	068115561B					
FRAM	PH2806					
FRAM	PH8					
GONHER	GPI					
GONHER	GP228					
INTERFIL	OF8994					

## ML-88227



**H** = 140 mm  
**OD** = 95 mm  
**TH** = 3/4"-16  
**BY PASS** = Y

CROSS REFERENCES		BRAND	MODEL	ENGINE	KW	
CHRYSLER	1739617	AUDI	A4			
FORD	2720E4601A	AUDI	CABRIOLET			
GM	93156247	AUDI	QUATTRO			
HONDA	15461551305	VOLKSWAGEN	EUROVAN			
MAZDA	WL8414302	VOLKSWAGEN	GOLF			
NISSAN	15208-65001	VOLKSWAGEN	JETTA			
TOYOTA	15208-65002	VOLKSWAGEN	PASSAT			
VW GROUP	028 115 561E					
FRAM	PH8					
INTERFIL	OF2815					

## ML-9018

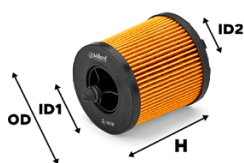

**H** = 89 mm  
**OD** = 64 mm  
**ID1** = 35 mm  
**ID2** = 30 mm

CROSS REFERENCES		BRAND	MODEL	ENGINE	KW	
FIAT	71752468	CHEVROLET	ASTRA			
FIAT	71769199	CHEVROLET	CAPTIVA			
GM	12605566	CHEVROLET	CAVALIER			
GM	21018801	CHEVROLET	HHR			
GM	22685727	CHEVROLET	IMPALA HYBRID			
GM	93175493	CHEVROLET	MALIBU			
FRAM	CH9018	CHEVROLET	MALIBU HYBRID			
FRAM	CH9018ECO	CHEVROLET	S10			
FRAM	PH9536	CHEVROLET	VECTRA			
INTERFIL	OF9018	CHEVROLET	ZAFIRA			

## ML-9090

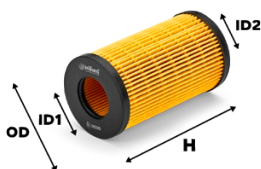

**H** = 115 mm

**OD** = 65 mm

**ID1** = 31 mm

**ID2** = 31 mm

CROSS REFERENCES		BRAND	MODEL	ENGINE	KW
CHRYSLER	05080244AA	CHRYSLER	CROSSFIRE		
FIAT	K05183748AA				
FIAT	K5183748AA				
FIAT	K71775180				
GM	90544191				
FRAM	CH8481				
FRAM	CH9011				
FRAM	CH9301				
INTERFIL	OF8481				
INTERFIL	OF9301				

## ML-92095



**H** = 72 mm

**OD** = 68 mm

**TH** = M18x1.5

**BY PASS** = Y

CROSS REFERENCES		BRAND	MODEL	ENGINE	KW
CHEVROLET	24103565	CHEVROLET	SPARK		
CHEVROLET	J96827723				
GM	24103565				
GM	25181616				
GM	9025229				
GM	96475855				
GM	96985730				
INTERFIL	OF2518				

## ML-9432

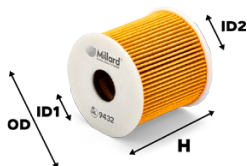

**H** = 74 mm

**OD** = 77 mm

**ID1** = 24 mm

**ID2** = 24 mm

CROSS REFERENCES		BRAND	MODEL	ENGINE	KW
NISSAN	15208-5M300	NISSAN	D22 (FRONTIER)		
NISSAN	15208-AD200	NISSAN	NP300		
NISSAN	15208-AD20A	NISSAN	PICK-UP		
NISSAN	15208-AD300				
NISSAN	15208-BN31A				
NISSAN	AY110-NS001				
FRAM	CH9432				
FRAM	CH9432ECO				
INTERFIL	OF200				

## ML-9463

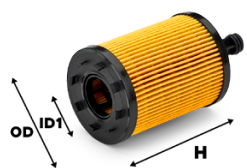

**H** = 143 mm

**OD** = 72 mm

**ID1** = 29 mm

**ID2** = 24 mm

CROSS REFERENCES		BRAND	MODEL	ENGINE	KW
CHRYSLER	68001297AA	AUDI			
FIAT	K68001297AA	SEAT			
FORD	YM216744AA	VOLKSWAGEN			
VW GROUP	045 115 466A				
VW GROUP	071 115 562A				
FRAM	CH9463				
FRAM	CH9463AECO				
FRAM	CH9463ECO				
GONHER	G466				
INTERFIL	OF9461				

## ML-9540

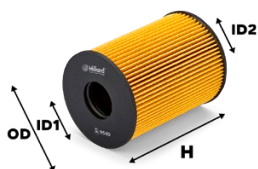

**H** = 103 mm

**OD** = 78 mm

**ID1** = 29 mm

**ID2** = 29 mm

CROSS REFERENCES		BRAND	MODEL	ENGINE	KW	
GM	93180258	NISSAN	URVAN			
NISSAN	15208-2W200					
NISSAN	15209-00QAC					
NISSAN	15209-2W200					
NISSAN	15209-MA70A					
NISSAN	AY110-NS002					
FRAM	CH9540					
FRAM	CH9540ECO					
INTERFIL	OF2092					

## ML-96796

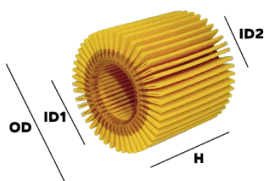

**H** = 57 mm

**OD** = 60 mm

**ID1** = 28 mm

**ID2** = 28 mm

CROSS REFERENCES		BRAND	MODEL	ENGINE	KW	
TOYOTA	04152-B1010	TOYOTA	COROLLA			
TOYOTA	41523-7010	TOYOTA	MATRIX			
TOYOTA	41524-0060	TOYOTA	MATRIX HYBRID			
FRAM	CH11252ECO	TOYOTA	PRIUS HYBRID			
INTERFIL	OF10358					

## ML-9814

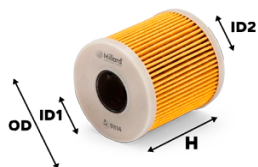

**H** = 69 mm

**OD** = 66 mm

**ID1** = 25 mm

**ID2** = 25 mm

CROSS REFERENCES		BRAND	MODEL	ENGINE	KW	
FIAT	9467521180	FORD	TRANSIT			
FIAT	CH10717ECO					
FORD	3M5Q6744AA					
FORD	6C1Q6744BA					
TOYOTA	SU001-A0178					
FRAM	CH9814					
FRAM	CH9814ECO					
FRAM	CH99743AECO					
INTERFIL	OF11Z1					
INTERFIL	OF6C67					

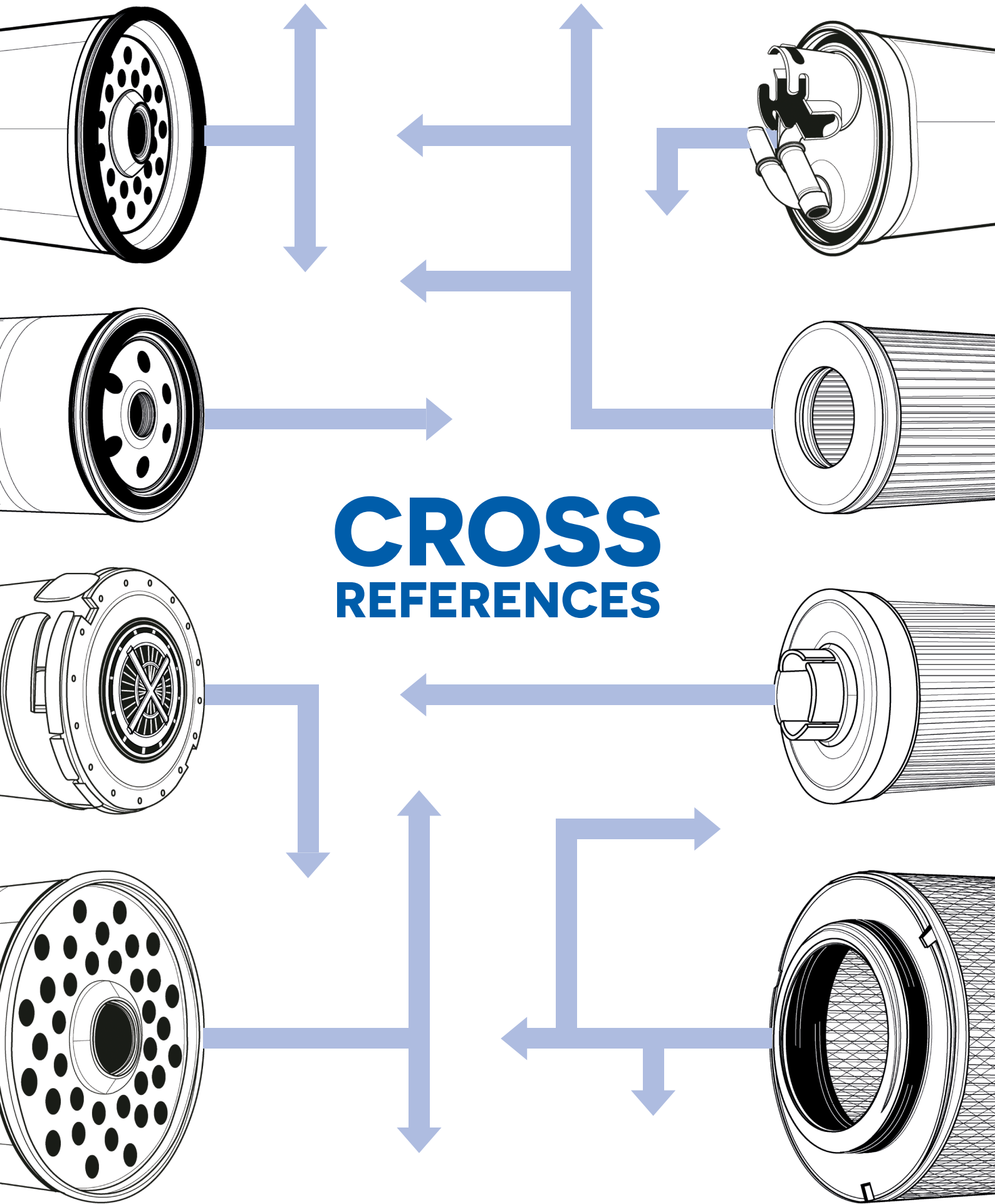

# CROSS REFERENCES

CROSS	MARCA	MILLARD
021115351A	VW GROUP	ML-16
028115561E	VW GROUP	ML-88227
028115561E	VW GROUP	ML-8
028115561G	VW GROUP	ML-8
030115561A	VW GROUP	ML-5548
030115561AA	VW GROUP	ML-5548
030115561AB	VW GROUP	ML-5548
030115561AD	VW GROUP	ML-5548
030115561AN	VW GROUP	ML-5548
030115561AP	VW GROUP	ML-5548
030115561B	VW GROUP	ML-5548
030115561C	VW GROUP	ML-16
030115561D	VW GROUP	ML-5552
030115561E	VW GROUP	ML-5548
030115561F	VW GROUP	ML-5548
030115561K	VW GROUP	ML-5548
030115561L	VW GROUP	ML-5548
030115561P	VW GROUP	ML-5548
030115561T	VW GROUP	ML-5548
032129620B	VW GROUP	MK-9015
034115561A	VW GROUP	ML-5552
036129620D	VW GROUP	MK-9015
037115561A	VW GROUP	ML-5552
037115561B	VW GROUP	ML-5552
03C115562	VW GROUP	ML-52149
03C115577A	VW GROUP	ML-52149
03P115562	VW GROUP	ML-321
04105409AB	CHRYSLER	ML-3614
04152B1010	TOYOTA	ML-96796
04152YZZA1	TOYOTA	ML-44155
04152YZZA4	TOYOTA	ML-12027
04152YZZA8	TOYOTA	ML-44155
045115389C	VW GROUP	ML-9463
045115466A	VW GROUP	ML-9463
045115466B	VW GROUP	ML-9463
045115466C	VW GROUP	ML-9463
047115561B	VW GROUP	ML-3614
047115561F	VW GROUP	ML-3614
047115561G	VW GROUP	ML-3614
047198561F	VW GROUP	ML-3614
04781452AA	CHRYSLER	ML-3600
04781452AB	CHRYSLER	ML-3600
04781452BB	CHRYSLER	ML-3600
04891694AA	CHRYSLER	MK-10118

CROSS	MARCA	MILLARD
04891694AA	DODGE	MK-10118
05003558AA	CHRYSLER	ML-5552
05003558AB	CHRYSLER	ML-5552
05018777AA	CHRYSLER	MK-18777
05018777AB	CHRYSLER	MK-18777
05080244AA	CHRYSLER	ML-9090
05080244AB	CHRYSLER	ML-9090
05086301AA	CHRYSLER	ML-9090
05102905AA	CHRYSLER	ML-9090
05102905AB	CHRYSLER	ML-9090
05117492AA	CHRYSLER	MF-73138
05175429AB	CHRYSLER	MF-73138
05183748AA	CHRYSLER	ML-9090
05189933AA	CHRYSLER	MK-16246
0520S	KS KOLBENSCHMIDT	ML-8
056115561A	VW GROUP	ML-5552
056115561B	VW GROUP	ML-5552
056115561C	VW GROUP	ML-5552
056115561G	VW GROUP	ML-5552
0570S	KS KOLBENSCHMIDT	ML-8
059115661A	VW GROUP	ML-5552
059133843A	VW GROUP	MK-5107
068115561A	VW GROUP	ML-88227
068115561A	VW GROUP	ML-8
068115561B	VW GROUP	ML-88227
068115561B	VW GROUP	ML-8
068115561C	VW GROUP	ML-88227
068115561C	VW GROUP	ML-8
068115561E	VW GROUP	ML-8
068115561F	VW GROUP	ML-88227
068115568B	VW GROUP	ML-88227
068115568B	VW GROUP	ML-8
06A115561	VW GROUP	ML-5552
06A115561B	VW GROUP	ML-5552
06A115561D	VW GROUP	ML-5552
06A115561E	VW GROUP	ML-5552
06C133843	VW GROUP	MK-25045
06D115466	VW GROUP	ML-14120
06D115562	VW GROUP	ML-14120
06D198405	VW GROUP	ML-14120
06H115403	VW GROUP	ML-64846
06H115561	VW GROUP	ML-64846
06J115403	VW GROUP	ML-64846
06J115403C	VW GROUP	ML-64846

CROSS	MARCA	MILLARD
06J115403J	VW GROUP	ML-64846
06J115403M	VW GROUP	ML-64846
06J115403Q	VW GROUP	ML-64846
06J115561B	VW GROUP	ML-64846
071115562A	VW GROUP	ML-9463
071115562B	VW GROUP	ML-9463
071115562C	VW GROUP	ML-9463
078115561D	VW GROUP	ML-8
078115561E	VW GROUP	ML-88227
078115561E	VW GROUP	ML-8
078115561H	VW GROUP	ML-8
078115561J	VW GROUP	ML-8
078115561K	VW GROUP	ML-5552
081323802A	MAZDA	ML-6607
081323802B	MAZDA	ML-6607
08292SCAE11	HONDA	MC-35422
08R79S5A600	HONDA	MC-35422
08R79S5AD00	HONDA	MC-35422
09AE6714AA	FOMOCO	ML-8
0B63114302	KIA	ML-3593
0B63114302	MAZDA	ML-6607
0FE3R14302	KIA	ML-3593
0FE3R14302	MAZDA	ML-3593
0HM6716BA	FORD	ML-16
OK2A513Z40A	KIA	MK-8548
OK41023802A	KIA	ML-6607
OK46723570	KIA	MF-4886
OK55114302	KIA	ML-42040
1001110	ASHIKA	ML-8
1001150003	MEYLE	ML-8
1001150005	MEYLE	ML-8
1002206	ASHIKA	ML-8
1002984	INTERCEPTOR	ML-8
100327	VAICO	ML-8
100327	VIACO	ML-8
1004051	FORD	MC-12021
1004509	FORD	MK-5682
101447	TOPRAN	ML-8
101519	TOPRAN	ML-8
1016238S01	NISSAN	ML-88227
1016239S01	NISSAN	ML-88227
1016268S01	NISSAN	ML-88227
1016269S01	NISSAN	ML-88227
1022150	FORD	MF-3526

CROSS	MARCA	MILLARD
1024245	FORD	MK-5107
1026285	FORD	ML-3614
1034065	MASSEY FERGUSON	ML-8
1037678	FORD	ML-5552
1043147	FORD	ML-3600
1047169	FORD	ML-3600
104891695AA	CHRYSLER	MK-10118
105000603000	ALFA ROMEO	ML-8
105234A	WHITE	ML-8
105548	MANITOU	ML-8
1058022	FORD	MK-5929
106000603000	ALFA ROMEO	ML-8
1062253	FORD	MC-67836C
1066071	FORD	ML-3600
1070523	FORD	ML-3614
1071746	FORD	ML-3600
1072246	FORD	MK-5929
1072434	FORD	ML-3614
1074	WORLD OF FILTERS	ML-8
1089	WORLD OF FILTERS	ML-8
1089896	FORD	MK-9896
1097077	FORD	ML-3600
109E9601A	FORD	MK-253
10R1328	MINNEAPOLIS	ML-8
1104020050	VW GROUP	ML-3614
1105094100	VW GROUP	ML-3614
1109F3	PEUGEOT	ML-8
1109Q7	CITROËN	ML-8
1112653	FORD	MF-4777
1118184	FORD	ML-9463
1119421	FORD	ML-5552
111AP	V T E	ML-8
1120167	FORD	MK-82139
1121106	FORD	MC-67836C
1121840125	MITSUBISHI	ML-9090
1121840425	MITSUBISHI	ML-9090
1129147	FORD	MK-5357
1139654	FORD	MC-67836C
11405640	FORD	ML-16
1140778	FORD	MK-15920
11425472	FORD	ML-16
1143	WORLD OF FILTERS	ML-8
1143677	FORD	ML-3614
11436936	FORD	ML-16

CROSS	MARCA	MILLARD
11464497	FORD	ML-16
11464498	FORD	ML-16
114932108	HANOMAG HENSCHEL	ML-8
1150100381	TOYOTA	ML-88227
1150100381	TOYOTA	ML-8
115094100	VW GROUP	ML-3614
11525472	FORD	ML-16
11525802	FORD	ML-16
11542957	FORD	ML-16
1173	WORLD OF FILTERS	ML-8
119003206101	ALFA ROMEO	ML-8
1191	NAPA	ML-8
1196	WORLD OF FILTERS	ML-8
119N	AGIP PETROLI	ML-8
1204459	FORD	MC-16462
1210134012800	FAHR (DEUTZ-FAHR)	ML-8
1213439	FORD	ML-88227
1213439	FORD (EUROPE)	ML-8
1213456	FORD	MF-4922
1216907	FORD	MK-82139
1218846	FORD	ML-3614
1220193	ONAN	ML-8
122150	FORD	MF-3526
12272453	DEUTZ	ML-8
1228022	TALBOT	ML-8
122P193	ONAN	ML-8
1230A105	MITSUBISHI	ML-3593
1232496	FORD	MK-5056
1238	WORLD OF FILTERS	ML-8
1250507	FORD	ML-3614
1250679	FORD	ML-9463
1257492	VOLVO	ML-8
12574927	VOLVO	ML-8
12579143	GM	ML-9018
12582255	GM	ML-3593
12605565	GM	ML-9018
12605566	GM	ML-9018
1303476	FORD	ML-9814
131129620	VW GROUP	MK-5301
132012	ISUZU	ML-8
132578	ALLIS CHALMERS	ML-8
13270886	GM	MK-9391
13270887	GM	MK-9391
13271041	GM	MK-5970

CROSS	MARCA	MILLARD
13271042	GM	MK-5970
13271043	GM	MK-9684
13272717	GM	MK-25175
13272719	GM	MK-14641
13272720	GM	MK-25175
132811110	FRAD	ML-8
1328126	VOLVO	ML-8
1339125	FORD	ML-5566
1353271	FORD	MC-12021
1354823	FIAT	ML-88227
1354823	FIAT	ML-8
1354828	FIAT	ML-88227
1354828	FIAT	ML-8
1371199	FORD	ML-14120
1373069	FORD	ML-9814
1373667	FORD	MK-73667
1382861	FORD	MC-67836C
1409070036	CASE	ML-8
1409070036	STEYR MOTORS	ML-8
1409070036	STEYR-DAIMLER-PUCH	ML-8
14105540	JUNGHEINRICH	ML-8
141055400	EATON	ML-8
1421704	FORD	ML-14120
1427824	FORD	ML-9814
1452	NAPA	ML-8
1452329	FORD	MC-67836C
145623570	MAZDA	MF-4886
145623570A	MAZDA	MF-4886
145623570A9A	MAZDA	MF-4886
1457512	FORD	ML-3614
145801	STILL	ML-8
1462805	FORD	ML-3614
1470819	FRISCH	ML-8
1473773	FORD	ML-16
1480568	FORD	MK-5929
1482151	FORD	ML-16
1485678	FORD	MF-5030
1486710	FORD	MK-5056
1498014	FORD	ML-3614
1498018	FORD	ML-16
1498020	FORD	ML-16
1498021	FORD	ML-16
1498022	FORD	ML-16
1498024	FORD	ML-16



CROSS	MARCA	MILLARD
1498027	FORD	ML-13
1498028	FORD	ML-88227
1498028	FOMOCO	ML-8
1498028	FORD (EUROPE)	ML-8
14API	FORD	ML-16
1500A023	MITSUBISHI	MK-41437
1500A086	MITSUBISHI	MK-41437
1500A098	MITSUBISHI	MK-51943
15015509	GM	MF-6397
15036141	GM	MK-9345
1508831	FORD	ML-16
1515160	FORD	ML-16
15153904	GM	MK-40048
1516725	FORD	MK-26934
1516739	FORD	MK-5929
1520565FO0	TOYOTA	ML-3593
1520660	FORD	ML-3614
1520800QOD	NISSAN	ML-5796
1520800QOF	NISSAN	ML-5796
1520800QOG	NISSAN	ML-5796
1520800QAB	NISSAN	ML-5796
1520800QAC	NISSAN	ML-5796
1520800QAF	NISSAN	ML-5796
1520813201	NISSAN	ML-3682
1520813210	NISSAN	ML-3600
1520813210	NISSAN	ML-3682
1520813211	NISSAN	ML-3682
1520813212	NISSAN	ML-3682
152081HCOA	NISSAN	ML-3593
152082W200	NISSAN	ML-9540
1520831000	NISSAN	ML-3593
1520831U00	NISSAN	ML-3593
1520831U01	NISSAN	ML-3593
1520832255	TOYOTA	ML-88227
1520832255	TOYOTA	ML-8
152083J400	NISSAN	ML-6607
152083J400XX	NISSAN	ML-6607
1520843G00	NISSAN	ML-88227
1520843GOA	NISSAN	ML-88227
1520853J00	NISSAN	ML-5166
1520853J01	NISSAN	ML-5166
1520853J100	NISSAN	ML-5166
1520855Y00	NISSAN	ML-3682
152085M300	NISSAN	ML-9432

CROSS	MARCA	MILLARD
1520860400	NISSAN	ML-3682
1520860U00	NISSAN	ML-3682
1520865001	NISSAN	ML-88227
1520865002	NISSAN	ML-88227
1520865002	TOYOTA	ML-88227
1520865002	TOYOTA	ML-8
1520865005	NISSAN	ML-8
1520865010	NISSAN	ML-88227
1520865011	NISSAN	ML-88227
1520865011	NISSAN	ML-8
1520865012	NISSAN	ML-88227
1520865014	NISSAN	ML-88227
1520865016	NISSAN	ML-88227
1520865210	NISSAN	ML-88227
1520865601	NISSAN	ML-88227
1520865601	NISSAN	ML-8
1520865FO0	NISSAN	ML-6607
1520865FO1	NISSAN	ML-6607
1520865FO1	TOYOTA	ML-6607
1520865FOA	NISSAN	ML-3593
1520865FOB	NISSAN	ML-3593
1520865FOC	NISSAN	ML-3593
1520865FOD	NISSAN	ML-3593
1520865F10	NISSAN	ML-6607
152086F901	NISSAN	ML-5566
152086F905	NISSAN	ML-5566
1520870J00	NISSAN	ML-5166
1520870J01	NISSAN	ML-5166
1520870J0A	NISSAN	ML-5166
1520871J00	NISSAN	ML-3682
1520871J0A	NISSAN	ML-3682
152087B000	NISSAN	ML-3593
152087F400	NISSAN	ML-88227
152087F40A	NISSAN	ML-88227
1520880W00	NISSAN	ML-16
152089	NISSAN	ML-3593
152089C600	NISSAN	ML-16
152089F600	NISSAN	ML-6607
152089F60A	NISSAN	ML-3593
152089X70A	NISSAN	ML-88227
152089X800	NISSAN	ML-88227
15208AD200	NISSAN	ML-9432
15208AD20A	NISSAN	ML-9432
15208AD300	NISSAN	ML-9432

CROSS	MARCA	MILLARD
15208AW300	NISSAN	ML-5796
15208BN300	NISSAN	ML-16
15208BN30A	NISSAN	ML-16
15208BN31A	NISSAN	ML-9432
15208BN700	NISSAN	ML-5796
15208BX00A	NISSAN	ML-5166
15208D9705	NISSAN	ML-16
15208G3100	NISSAN	ML-3682
15208G9903	NISSAN	ML-88227
15208H1010	NISSAN	ML-3682
15208H1011	NISSAN	ML-3682
15208H8901	NISSAN	ML-3682
15208H8903	NISSAN	ML-3682
15208H8904	NISSAN	ML-3682
15208H8905	NISSAN	ML-3682
15208H8910	NISSAN	ML-3682
15208H8911	NISSAN	ML-3682
15208H8912	NISSAN	ML-3682
15208H8916	NISSAN	ML-3682
15208H8917	NISSAN	ML-3682
15208H8920	NISSAN	ML-3682
15208H8923	NISSAN	ML-3682
15208H8990	NISSAN	ML-3682
15208HA000	NISSAN	ML-3682
15208HA300	NISSAN	ML-6355
15208Q9100	NISSAN	ML-3682
15208U3401	NISSAN	ML-88227
15208V4000	NISSAN	ML-5552
15208V4960	NISSAN	ML-88227
15208V4960	NISSAN	ML-8
15208W1103	NISSAN	ML-16
15208W1106	NISSAN	ML-16
15208W1111	NISSAN	ML-16
15208W1113	NISSAN	ML-16
15208W1116	NISSAN	ML-16
15208W1120	NISSAN	ML-88227
15208W1123	NISSAN	ML-88227
15208W1123	NISSAN	ML-8
15208W1193	NISSAN	ML-8
15208W3401	NISSAN	ML-88227
15208W3403	NISSAN	ML-88227
15208Y9701	NISSAN	ML-8
15208Z9003	NISSAN	ML-49
1520900QAC	NISSAN	ML-9540

CROSS	MARCA	MILLARD
152092W200	NISSAN	ML-9540
15209MA70A	NISSAN	ML-9540
15209T9005	NISSAN	ML-88227
1523494	FORD	ML-88227
152849	MEAT & DORIA	ML-8
153229	HOFFER	ML-8
153229	MEAT & DORIA	ML-8
1536304	FORD	ML-3614
15400MCJ000	HONDA	ML-6607
15400MCJ003	HONDA	ML-6607
15400MCJ505	HONDA	ML-6607
15400MFJD01	HONDA	ML-6607
15400MM5013	HONDA	ML-6607
15400MM9003	HONDA	ML-6607
15400MM9013	HONDA	ML-6607
15400MM9405	HONDA	ML-6607
15400MT7003	HONDA	ML-6607
15400POH305	HONDA	ML-6607
15400POH305	HONDA	ML-3593
15400POH305PE	HONDA	ML-6607
15400PCX004	HONDA	ML-6607
15400PFB004	HONDA	ML-6607
15400PFB007	HONDA	ML-6607
15400PFB014	HONDA	ML-6607
15400PJ7005	HONDA	ML-6607
15400PJ7015	HONDA	ML-6607
15400PLC003	HONDA	ML-3593
15400PLC004	HONDA	ML-3593
15400PLMA00	HONDA	ML-6607
15400PLMA01	HONDA	ML-3593
15400PLMA01PE	HONDA	ML-6607
15400PLMA02	HONDA	ML-3593
15400PM3405	HONDA	ML-6607
15400PMET01	HONDA	ML-3593
15400RBAF01	HONDA	ML-3593
15400RTA003	HONDA	ML-3593
15400RTA004	HONDA	ML-3593
15400ZIJ004	HONDA	ML-6607
15400ZW4003	HONDA	ML-6607
1540232430	KUBOTA	ML-8
1541281002	SAURER	ML-8
15461551305	HONDA	ML-88227
15461551305	HONDA	ML-8
15461551315	HONDA	ML-88227

CROSS	MARCA	MILLARD
15461551315	HONDA	ML-8
1540S	HONDA	ML-88227
1540S	HONDA	ML-8
1553370	FORD	ML-3614
1555370	FORD	ML-3614
1555451	FORD	ML-16
1556297	FORD	ML-16
155955	DITCH WITCH	ML-8
1559937	FORD	ML-3614
1560001010	TOYOTA	ML-44155
1560013011	TOYOTA	ML-4967
1560013050	TOYOTA	ML-4967
1560013051	TOYOTA	ML-3614
1560016020	TOYOTA	ML-4967
1560020560	TOYOTA	ML-88227
1560020560	TOYOTA	ML-8
1560020571	TOYOTA	ML-88227
1560020571	TOYOTA	ML-8
1560025010	TOYOTA	ML-16
156002501083	TOYOTA	ML-16
1560040010	TOYOTA	ML-88227
1560040010	TOYOTA	ML-8
1560041010	TOYOTA	ML-88227
1560041010	AUTOX	ML-8
1560041010	DAIHATSU	ML-8
1560041010	MANITOU	ML-8
1560041010	TOYOTA	ML-8
1560041020	TOYOTA	ML-88227
1560041020	TOYOTA	ML-8
1560041040	TOYOTA	ML-88227
1560041040	TOYOTA	ML-8
1560044010	TOYOTA	ML-88227
1560044010	TOYOTA	ML-8
1560050010	TOYOTA	ML-88227
1560050010	TOYOTA	ML-8
156007600371	TOYOTA	ML-88227
156007600371	TOYOTA	ML-8
1560087202	DAIHATSU	ML-8
1560087320	DAIHATSU	ML-8
1560096001	TOYOTA	ML-16
1560101010	TOYOTA	ML-4967
1560113010	TOYOTA	ML-3614
1560113011	TOYOTA	ML-3614
1560113051	TOYOTA	ML-3614

CROSS	MARCA	MILLARD
1560120550	TOYOTA	ML-88227
1560120550	TOYOTA	ML-8
156012055071	TOYOTA	ML-88227
156012055071	TOYOTA	ML-8
1560120560	TOYOTA	ML-88227
1560120560	TOYOTA	ML-8
1560125010	TOYOTA	ML-16
1560130010	TOYOTA	ML-88227
1560130010	TOYOTA	ML-8
1560141010	TOYOTA	ML-88227
1560141010	TOYOTA	ML-8
1560144010	TOYOTA	ML-88227
1560144010	TOYOTA	ML-8
1560144010000	DAIHATSU	ML-8
156014401083	TOYOTA	ML-88227
1560144011	TOYOTA	ML-88227
1560144011	DAIHATSU	ML-8
1560144011	TOYOTA	ML-8
1560176003	TOYOTA	ML-88227
1560176003	TOYOTA	ML-8
156017600371	TOYOTA	ML-88227
156017600371	TOYOTA	ML-8
1560176009	TOYOTA	ML-3614
156017600971	TOYOTA	ML-3614
1560178001	TOYOTA	ML-16
156017800171	TOYOTA	ML-16
1560178010	TOYOTA	ML-6355
156017810171	TOYOTA	ML-88227
156017810171	TOYOTA	ML-8
1560196001	TOYOTA	ML-16
1560196006	TOYOTA	ML-16
1560196101	TOYOTA	ML-88227
1560196101	TOYOTA	ML-8
1560A41010	HINO	ML-8
1560B41010000	DAIHATSU	ML-8
15611U316071	TOYOTA	ML-3387
156153172071	TOYOTA	ML-3387
1564767	FORD	ML-16
1565204	FORD	ML-88227
1565486	FORD	ML-16
1579565	FORD	MK-5107
1579605	FORD	MK-5107
158	AGIP PETROLI	ML-8
1581167	FORD	MK-82139

CROSS	MARCA	MILLARD
1585195	FORD	MC-67836C
1585216	FORD	MC-16462
159045A	WHITE	ML-8
159045AS	WHITE	ML-8
15942429	GM	MK-76855
1596790	FORD	MF-2000
16010S01A30	HONDA	MF-7599
16010S01A31	HONDA	MF-7599
16010S01A32	HONDA	MF-7599
16010SM4315	HONDA	MF-6826
16010SM4506	HONDA	MF-6826
16010SM4931	HONDA	MF-6826
16010SM4932	HONDA	MF-6826
16010SM4951	HONDA	MF-6826
16010SM4952	HONDA	MF-6826
16010SM4A30	HONDA	MF-6826
16010SM4K50	HONDA	MF-6826
16010SM4K51	HONDA	MF-6826
16010SM4K52	HONDA	MF-6826
16010ST5931	HONDA	MF-7599
16010ST5932	HONDA	MF-7599
16010ST5933	HONDA	MF-7599
16010ST5E01	HONDA	MF-7599
16010ST5E02	HONDA	MF-7599
16103C9900	NISSAN	MF-5138
1614735	FORD	ML-88227
1614735	FORD (EUROPE)	ML-8
16196227	ATLAS COPCO	ML-8
1619622700	ATLAS COPCO	ML-8
1621210M1	MASSEY FERGUSON	ML-8
1621224M1	EICHER	ML-8
1621224M1	MASSEY FERGUSON	ML-8
162709	CLARK	ML-8
1640000QAA	NISSAN	MF-5857
164000B000	NISSAN	MF-7404
164000W000	NISSAN	MF-4777
164000W005	NISSAN	MF-4777
164000W010	NISSAN	MF-4777
164000W01A	NISSAN	MF-4777
1640010Y00	NISSAN	MF-5237
1640041B00	NISSAN	MF-4777
1640041B05	NISSAN	MF-4777
1640041B1A	NISSAN	MF-4777
1640070J00	NISSAN	MF-5030

CROSS	MARCA	MILLARD
1640072L00	NISSAN	MF-5237
1640072L05	NISSAN	MF-5237
1640072L10	NISSAN	MF-5237
164009F910	NISSAN	MF-4777
164009F928	NISSAN	MF-4777
164009F928KE	NISSAN	MF-4777
16400D0300	NISSAN	MF-4777
16400D0300	NISSAN	MF-4777
16400F5100	NISSAN	MF-4777
16400F5700	NISSAN	MF-4777
16400C9601	NISSAN	MF-4777
16400J7525	NISSAN	MF-5030
16400JD51A	NISSAN	MF-5857
16400N8601	NISSAN	MF-7404
16400CW005	NISSAN	MF-4777
16400V2700	NISSAN	MF-4777
16400V2705	NISSAN	MF-4777
16400VB201	NISSAN	MF-5138
16400VC100	NISSAN	MF-5138
1640306J60	NISSAN	MF-29882
164032SA00	NISSAN	MF-4922
164034U105	NISSAN	MF-5138
1640359	NISSAN	MF-5138
1640359	NISSAN	MF-5138
1640359E0A	NISSAN	MF-5138
16403G2400	NISSAN	MF-5138
16403G9900	NISSAN	MF-5138
16403G990A	NISSAN	MF-5138
1640501T0A	NISSAN	MF-29882
1640501T70	NISSAN	MF-29882
16405050	NISSAN	MF-5138
16405050	NISSAN	MF-5138
1640559	NISSAN	MF-5138
1640559	NISSAN	MF-5138
16405V5710	NISSAN	MF-29882
1641158	FORD	ML-16
16414310	MAZDA	ML-16
16414310	MAZDA	ML-16
164830	WAUKESHA	ML-8
165002J201	NISSAN	MK-43080
1650041020	TOYOTA	ML-88227
1650041020	TOYOTA	ML-8
1651083011	TOYOTA	ML-3614
1654600QAA	NISSAN	MK-8964

CROSS	MARCA	MILLARD
1654600QAU	NISSAN	MK-8964
1654602N00	NISSAN	MK-253
1654602N01	NISSAN	MK-253
165460U800	NISSAN	MK-5468
165460U80A	NISSAN	MK-5468
165460Z000	NISSAN	MK-43080
1654617B00	NISSAN	MK-6900
165461HC2A	NISSAN	MK-6900
1654630P00	NISSAN	MK-6900
165463J400	NISSAN	MK-43080
165463J410	NISSAN	MK-6900
165463J41A	NISSAN	MK-6900
165464100	NISSAN	MK-5468
1654641B00	NISSAN	MK-5468
165466J400	NISSAN	MK-43080
1654670J00	NISSAN	MK-43080
1654670J10	NISSAN	MK-43080
1654670Y10	NISSAN	MK-43080
1654673C00	NISSAN	MK-6900
1654673C01	NISSAN	MK-6900
1654673C10	NISSAN	MK-6900
1654673C11	NISSAN	MK-6900
1654674S00	NISSAN	MK-43080
1654676015	NISSAN	MK-3660
165467S000	NISSAN	MK-7440
165467S015	NISSAN	MK-7440
1654686G00	NISSAN	MK-6850
1654695001	NISSAN	MK-95021
165469S000	NISSAN	MK-95021
165469S001	NISSAN	MK-95021
165469S00B	NISSAN	MK-95021
16546AA020	NISSAN	MK-43080
16546AA030	NISSAN	MK-6900
16546AA050	NISSAN	MK-43080
16546AX60	NISSAN	MK-5468
16546AX600	NISSAN	MK-5468
16546AX60A	NISSAN	MK-5468
16546E6810	NISSAN	MK-95021
16546ED000	NISSAN	MK-35681
16546ED500	NISSAN	MK-35681
16546HC000	NISSAN	MK-8970
16546JG30A	NISSAN	MK-6900
16546T9300	NISSAN	MK-5070
16546V0100	NISSAN	MK-43080

CROSS	MARCA	MILLARD
16546V0110	NISSAN	MK-43080
16546V0192	NISSAN	MK-43080
16546VK500	NISSAN	MK-95021
16546VK501	NISSAN	MK-95021
16546W2900	NISSAN	MK-43080
1663050	FORD	ML-3600
1663051	FORD	ML-3600
16655	WESTERBEKE	ML-8
1669779	FORD	MF-5030
1672948	FORD	MC-67836C
168106536	CHRIS-CRAFT	ML-8
168444	WAUKESHA	ML-8
16900SM3A32	HONDA	MF-6826
16900SM4931	HONDA	MF-6826
16900SM4A31	HONDA	MF-6826
16900SM4A32	HONDA	MF-6826
16900SM4A33	HONDA	MF-6826
169741	HYSTER	ML-8
1699522	FORD	ML-3593
17131	CHRIS-CRAFT	ML-8
1714387	FORD	ML-3614
171549	MANITOU	ML-8
171550	MANITOU	ML-8
1717510	FORD	ML-9814
1719859	BOLENS (FMC)	ML-8
17200PT2000	HONDA	MK-6807
17220POA000	HONDA	MK-7420
17220POAA00	HONDA	MK-7420
17220P2A000	HONDA	MK-6900
17220P2A003	HONDA	MK-6900
17220P2A005	HONDA	MK-6900
17220P2A505	HONDA	MK-6900
17220P2CY01	HONDA	MK-6900
17220P2FA01	HONDA	MK-6900
17220P2FY00	HONDA	MK-7764
17220P2J003	HONDA	MK-7764
17220P2M505	HONDA	MK-7764
17220P2MY00	HONDA	MK-7764
17220P2NA01	HONDA	MK-7764
17220P2NE01	HONDA	MK-7764
17220P2PA00	HONDA	MK-7764
17220P45G00	HONDA	MK-6807
17220PLC000	HONDA	MK-8911
17220PM2Y00	HONDA	MK-7764

CROSS	MARCA	MILLARD
17220PM4003	HONDA	MK-7764
17220PMRA00	HONDA	MK-8911
17220POA000	HONDA	MK-7420
17220POAA00	HONDA	MK-7420
17220POCY00	HONDA	MK-7420
17220PT0003	HONDA	MK-6807
17220PT2000	HONDA	MK-6807
17220PT2305	HONDA	MK-6807
17220PWA000	HONDA	MK-72373
17220PWA003	HONDA	MK-72373
17220PWAY00	HONDA	MK-72373
17220PWC000	HONDA	MK-72373
17220PW-C505HE	HONDA	MK-72373
17220PY2000	HONDA	MK-6807
17220RB0000	HONDA	MK-94973
17220RNAA00	HONDA	MK-80146
17220RNDM00	HONDA	MK-80146
1727561	FORD	ML-9814
1729416	FORD	MK-73667
1729854	FORD	MK-15920
1729860	FORD	MK-26934
1739617	CHRYSLER	ML-88227
1739617	CHRYSLER	ML-8
173961789	TALBOT	ML-8
1739618	CHRYSLER	ML-88227
1739618	CHRYSLER	ML-8
1739619	CHRYSLER	ML-88227
1739619	CHRYSLER	ML-8
1770028160	TOYOTA	MK-20040
1770A053	MITSUBISHI	MF-4922
1770A055	MITSUBISHI	MF-4922
1780101H10	TOYOTA	MK-20040
1780102030	TOYOTA	MK-5466
1780103010	TOYOTA	MK-7351
1780108010	TOYOTA	MK-64676
178010C010	TOYOTA	MK-0C010
178010C01000	TOYOTA	MK-0C010
178010C020	TOYOTA	MK-0C010
178010C030	TOYOTA	MK-0C010
178010D010	TOYOTA	MK-9482
178010D011	TOYOTA	MK-9482
178010D020	TOYOTA	MK-9482
178010D060	TOYOTA	MK-21050
178010H010	TOYOTA	MK-20040

CROSS	MARCA	MILLARD
178010H020	TOYOTA	MK-20040
178010H050	TOYOTA	MK-20040
178010M020	TOYOTA	MK-21050
178010P010	TOYOTA	MK-9683
178010W010	TOYOTA	MK-8067
178010Y010	TOYOTA	MK-9115
1780115060	TOYOTA	MK-6544
178011506083	TOYOTA	MK-6544
1780115070	TOYOTA	MK-5466
1780120040	TOYOTA	MK-20040
1780121030	TOYOTA	MK-9115
1780121050	TOYOTA	MK-21050
1780122020	TOYOTA	MK-9482
1780131090	TOYOTA	MK-9683
17801-31120	TOYOTA	MK-83293
1780135020	TOYOTA	MK-64676
178013502083	TOYOTA	MK-64676
1780137010	TOYOTA	MK-4939
1780141050	TOYOTA	MK-4939
1780141090	TOYOTA	MK-4939
178014109083	TOYOTA	MK-4939
1780154100	TOYOTA	MK-52391
178015410083	TOYOTA	MK-52391
17801541008T	TOYOTA	MK-52391
1780154110	TOYOTA	MK-52391
1780155020	TOYOTA	MK-64676
1780164030	TOYOTA	MK-52391
1780170020	TOYOTA	MK-4939
178017002083	TOYOTA	MK-4939
1780174060	TOYOTA	MK-7351
1780175010	TOYOTA	MK-52391
17801-AD010	TOYOTA	MK-83293
1794446	FORD	ML-88227
1794446	FORD (EUROPE)	ML-8
1794466	FORD	ML-88227
1794466	FORD (EUROPE)	ML-8
18010081006	KOSHIMO	ML-8
1803059	FORD	MK-26934
1810699	FORD	MK-26934
1812551	FORD	ML-10060
1827183	FORD	ML-88227
1827183	FORD (EUROPE)	ML-8
1829195	FORD	ML-88227
1829195	FORD (EUROPE)	ML-8

CROSS	MARCA	MILLARD
1834108	BENATI	ML-8
1836805	FORD	MK-26934
1851658	CHRYSLER	ML-88227
1851658	CHRYSLER	ML-8
1909139	FIAT	MK-253
191129620	VW GROUP	MK-5301
1930213	FIAT	ML-4847
1930328	FIAT-AGRI	ML-8
1930328	IVECO	ML-8
1930329	FIAT-AGRI	ML-8
1930329	IVECO	ML-8
1930766	FIAT-ALLIS	ML-8
195852	HYSTER	ML-8
1959757C1	CASE	ML-8
1960297	FORD	MF-4777
1961451	FORD	ML-3682
1986452001	BOSCH	ML-8
1986452002	BOSCH	ML-8
1E0013Z40	MAZDA	MK-5682
1E0061J6X	MAZDA	MC-12021
1E0061J6XB	MAZDA	MC-12021
1E0061J6XC	MAZDA	MC-12021
1E0061J6XD	MAZDA	MC-12021
1E0314302	MAZDA	ML-3614
1E0320490	MAZDA	MF-3526
1E0414302	MAZDA	ML-3614
1E0420490	MAZDA	MF-3526
1E0513490	MAZDA	MF-3526
1E0514302	MAZDA	ML-20004
1E0814302	MAZDA	ML-3614
1E0814302A	MAZDA	ML-3614
1E1314302	MAZDA	ML-3614
1E1314302A	MAZDA	ML-3614
1F0129620	VW GROUP	MK-35495
1F7013470A	MAZDA	MF-1036
1F0129620	VW GROUP	MK-35495
1H0129620	VW GROUP	MK-7431
1H0201511	VW GROUP	MF-5030
1H0201511A	VW GROUP	MF-5030
1H0819638	VW GROUP	MC-5663
1H0819638A	VW GROUP	MC-5663
1H0819638B	VW GROUP	MC-5663
1H0819644	VW GROUP	MC-5663
1H0819644A	VW GROUP	MC-5663

CROSS	MARCA	MILLARD
1H0819644B	VW GROUP	MC-5663
1H0819698	VW GROUP	MC-5663
1HMI29620	VW GROUP	MK-7431
1H0201511	VW GROUP	MF-5030
1H0819644	VW GROUP	MC-5663
1J0129620	VW GROUP	MK-5827
1J0129620A	VW GROUP	MK-5827
1J0201511A	VW GROUP	MF-5870
1JM115561BZ	VW GROUP	ML-5552
1J0129620	VW GROUP	MK-5827
1J0201511A	VW GROUP	MF-5870
1K0127177	VW GROUP	MF-52021
1K0127177A	VW GROUP	MF-52021
1K0127434	VW GROUP	MF-52021
1K0127434A	VW GROUP	MF-52021
1K0129607C	VW GROUP	MK-35495
1K0129620	VW GROUP	MK-69754
1K0129620C	VW GROUP	MK-35495
1K0129620D	VW GROUP	MK-69754
1K0129620E	VW GROUP	MK-69754
1K0129620F	VW GROUP	MK-69754
1K0129620G	VW GROUP	MK-69754
1K0201051	VW GROUP	MF-74120
1K0201051K	VW GROUP	MF-74120
1L0129601C	VW GROUP	MK-5377
1L0129601D	VW GROUP	MK-5377
1L0129607M	VW GROUP	MK-5377
1L0129607N	VW GROUP	MK-5377
1L0129607Q	VW GROUP	MK-5377
1L0129620	VW GROUP	MK-5377
1L0129620A	VW GROUP	MK-5377
1L0129620C	VW GROUP	MK-5377
1L2Z9601AA	FORD	MK-9332
1L0129601C	VW GROUP	MK-5377
1L0129601D	VW GROUP	MK-5377
1L0129607M	VW GROUP	MK-5377
1L0129607N	VW GROUP	MK-5377
1L0129620	VW GROUP	MK-5377
1L0129620A	VW GROUP	MK-5377
1L0129620C	VW GROUP	MK-5377
1N0114302	MAZDA	ML-16
1S719601A1B	FORD	MK-82139
1S719601AA	FORD	MK-82139
1S719601AB	FORD	MK-82139

CROSS	MARCA	MILLARD
1S7G6714CA	FORD	ML-3614
1S7G6714DA	FORD	ML-3614
1S7J6744AC	FORD	ML-321
1S7Z6731DA	FORD	ML-3600
201	TOYO FILTER	ML-8
2014	CROSLAND	ML-8
201950001	VW GROUP	ML-3614
2029	CROSLAND	ML-8
20301K1360	KOMATSU	ML-8
2049	CROSLAND	ML-8
2090736	STEYR-DAIM- LER-PUCH	ML-8
21000872	GM	ML-3614
21018801	GM	ML-9018
21515	NAPA	ML-8
21844001	MERCEDES BENZ	ML-8
2205517	CHRYSLER	ML-88227
2205517	CHRYSLER	ML-8
22106	JAPAN LINE	ML-8
2220425	FIAT	ML-88227
2220425	LANCIA	ML-8
22214300	MAZDA	ML-6607
22214300	MAZDA	ML-3593
22548	FEBI BILSTEIN	ML-8
22665803	ZETTELMEYER	ML-8
22685727	GM	ML-9018
230578	ALLIS CHALMERS	ML-8
2305781	ALLIS CHALMERS	ML-8
2305781	STILL	ML-8
2310200	U.F.I.	ML-8
2310202	U.F.I.	ML-8
2310203	U.F.I.	ML-8
2310204	U.F.I.	ML-8
2316400	U.F.I.	ML-8
2316403	U.F.I.	ML-8
2318100	U.F.I.	ML-8
232241	ALLIS CHALMERS	ML-8
2324100	U.F.I.	ML-8
232421	ALLIS CHALMERS	ML-8
2324211	ALLIS CHALMERS	ML-8
232578	ALLIS CHALMERS	ML-8
2325784	ALLIS CHALMERS	ML-8
2329700	U.F.I.	ML-8
2330011150	TOYOTA	MF-3541
2330011160	TOYOTA	MF-3541

CROSS	MARCA	MILLARD
233001190	TOYOTA	MF-3541
2330016290	TOYOTA	MF-3541
2330016330	TOYOTA	MF-3541
2330019025	TOYOTA	MF-3541
2330019145	TOYOTA	MF-9145
2330019205	TOYOTA	MF-3541
2330019235	TOYOTA	MF-3541
2330019245	TOYOTA	MF-3541
2330019255	TOYOTA	MF-3541
2330019265	TOYOTA	MF-3541
2330019375	TOYOTA	MF-3541
2330019385	TOYOTA	MF-3541
2330019415	TOYOTA	MF-3541
2330019465	TOYOTA	MF-3541
2330019475	TOYOTA	MF-3541
2330019535	TOYOTA	MF-3541
2330020020	TOYOTA	MF-3541
2330022040	TOYOTA	MF-3541
2330029045	TOYOTA	MF-3541
2330029055	TOYOTA	MF-3541
2330034000	TOYOTA	MF-6680
2330050020	TOYOTA	MF-6680
2330050040	TOYOTA	MF-6680
2330050050	TOYOTA	MF-6680
2330061010	TOYOTA	MF-6680
2330061020	TOYOTA	MF-6680
2330062010	TOYOTA	MF-6680
2330062020	TOYOTA	MF-6680
2330062030	TOYOTA	MF-6680
2330065010	TOYOTA	MF-6680
2330065020	TOYOTA	MF-6680
2330074040	TOYOTA	MF-3541
2330074050	TOYOTA	MF-3541
2330074260	TOYOTA	MF-4132
2330074290	TOYOTA	MF-3541
2330074300	TOYOTA	MF-75110
2330074310	TOYOTA	MF-75110
2330075010	TOYOTA	MF-75110
2330075110	TOYOTA	MF-75110
2330075140	TOYOTA	MF-41570
2330079105	TOYOTA	MF-9145
2330079175	TOYOTA	MF-3541
2330079185	TOYOTA	MF-3541
2330079235	TOYOTA	MF-3541

CROSS	MARCA	MILLARD
2330079255	TOYOTA	MF-75110
2330079335	TOYOTA	MF-3541
2330079495	TOYOTA	MF-4132
2330079545	TOYOTA	MF-3541
2330087733	TOYOTA	MF-3541
2330087735	TOYOTA	MF-3541
2330087742	TOYOTA	MF-3541
2330364010	TOYOTA	MF-4922
2330364020	TOYOTA	MF-4922
2330364021	TOYOTA	MF-4922
233037600271M	TOYOTA	MF-4922
2330376021	TOYOTA	MF-4922
2334729	CLARK	ML-8
2339024480	TOYOTA	MF-4922
2339030180	TOYOTA	MF-4922
2339064480	TOYOTA	MF-4922
23390YZZAB	TOYOTA	MF-4922
2346540	U.F.I.	ML-8
234900	ALLIS CHALMERS	ML-8
2349008	ALLIS CHALMERS	ML-8
235781	ALLIS CHALMERS	ML-8
237000	ALLIS CHALMERS	ML-8
2370005	ALLIS CHALMERS	ML-8
2370007	ALLIS CHALMERS	ML-8
239330	SAVARA	ML-8
239330A	SAVARA	ML-8
24103565	CHEVROLET	ML-92095
24103565	GM	ML-92095
24151017	MAN	ML-8
24151017	RENAULT	ML-8
2415101718	RENAULT	ML-8
24151018	RENAULT	ML-8
24151018	RENAULT TRUCKS	ML-8
244191300	SAME	ML-8
2441913001	SLH	ML-8
244191301	SLH	ML-8
24419130101	SAME	ML-8
244191501	HUERLIMANN	ML-8
244191501	LAMBORGHINI	ML-8
244191501	SAME	ML-8
244427M1	MASSEY FERGUSON	ML-8
24443113	GM	MK-5970
24460713	GM	ML-9018
245151017	MAN	ML-8

CROSS	MARCA	MILLARD
24515217	MAN	ML-8
2458807	CHRYSLER	ML-88227
2458807	CHRYSLER	ML-8
2458957	CHRYSLER	ML-88227
2458957	CHRYSLER	ML-8
2471400	CHRYSLER	ML-88227
2471400	DODGE	ML-88227
24746008	HYUNDAI	MK-253
25010251	GM	ML-4952
25013454	GM	ML-13
25014377	GM	ML-3675
25014748	GM	ML-3675
25055046	GM	MF-481
25055052	GM	MF-481
25055128	GM	MF-481
25055129	GM	MF-481
25055302	GM	MF-800
25055428	GM	MF-3747
25055480	GM	MF-481
25055495	GM	MF-5030
25062055	GM	MK-5107
25062071	GM	MK-5107
25062072	GM	MK-5107
25062209	GM	MK-5929
25062212	GM	MK-43080
25062220	GM	MK-43080
25062221	GM	MK-5107
25062227	GM	MK-9015
25062272	GM	MK-9015
25062320	GM	MK-43080
25062406	GM	MK-5107
25062416	GM	MK-5107
25062418	GM	MK-9015
25067018	GM	ML-88227
25067018	GM	ML-8
25067058	GM	MF-3744
25067059	GM	MF-5030
25067071	GM	MF-3747
25067093	GM	ML-4847
25067131	GM	MF-3526
25095333	GM	MK-3916
25096932	GM	MK-6479
25098463	GM	MK-7421
25098845	GM	MK-3916

CROSS	MARCA	MILLARD
25099149	GM	MK-7597
251178	ALLIS CHALMERS	ML-8
251201511A	VW GROUP	MF-5030
251201511H	VW GROUP	MF-5030
25121074	GM	MF-618
25121130	GM	MF-481
25121255	GM	MF-481
25121293	GM	MF-578
25121353	GM	MF-618
25121449	GM	MF-578
25121466	GM	MF-580
25121468	GM	MF-580
25121600	GM	MF-4777
25121741	GM	MF-481
25121757	GM	MF-9145
25121792	GM	MF-481
25121914	GM	MF-481
25121915	GM	MF-481
25126113	GM	MF-618
2513810	ALLIS CHALMERS	ML-8
25160729	GM	MF-618
25161333	GM	MF-618
25165627	GM	MK-7597
25166562	GM	MF-618
25168081	GM	MK-8038
25168251	GM	MF-645A
25168594	GM	MF-645A
25171109	GM	MF-481
25171792	GM	MF-481
25171972	GM	MF-481
25175325	GM	MK-7617
25175534	GM	MF-6680
25175557	GM	MF-5237
25175574	GM	MF-6680
25176275	GM	MF-6826
25176294	GM	MF-7404
25176295	GM	MF-7404
25176324	GM	MF-7599
25181616	GM	ML-92095
25311970	GM	MK-8069
25313357	GM	MF-618
25313359	GM	MF-618
25313807	GM	MF-9000
25313811	GM	MF-4132

CROSS	MARCA	MILLARD
25313817	GM	MF-3521
2532744	CHRYSLER	ML-88227
2532744	CHRYSLER	ML-8
25329183	GM	MF-618
2536186	CHRYSLER	ML-88227
2536186	CHRYSLER	ML-8
2555929	CHRYSLER	ML-88227
2555929	CHRYSLER	ML-8
25750701	GM	MK-5377
25914300	MAZDA	ML-3593
259264	HYSTER	ML-8
26055129	GM	MF-481
261155612	VW GROUP	ML-5552
261155613	VW GROUP	ML-5552
261155613	VW GROUP	ML-5552
261627R91	IHC / CASE IH	ML-8
261627R92	IHC / CASE IH	ML-8
261906R92	IHC / CASE IH	ML-8
262034R91	IHC / CASE IH	ML-8
262146R91	IHC / CASE IH	ML-8
262146R92	IHC / CASE IH	ML-8
262146R94	IHC / CASE IH	ML-8
2630002500	HYUNDAI	ML-6607
2630002500	KIA	ML-6607
2630002501	HYUNDAI	ML-6607
2630002501	KIA	ML-6607
2630002502	HYUNDAI	ML-6607
2630002502	KIA	ML-6607
2630002750	HYUNDAI	ML-3593
2630002750	KIA	ML-6607
2630002751	HYUNDAI	ML-3593
2630021010	HYUNDAI	ML-5566
2630021010	MITSUBISHI	ML-5566
2630029000	HYUNDAI	ML-5566
263002Y500	HYUNDAI	ML-6607
263002Y500	KIA	ML-6607
2630035502	KIA	ML-6607
2630035503	KIA	ML-3593
2630042000	HYUNDAI	ML-6355
2630042010	HYUNDAI	ML-6355
2630042020	HYUNDAI	ML-6355
2630042030	HYUNDAI	ML-42040
2630042040	HYUNDAI	ML-42040
2630042060	HYUNDAI	ML-42040

CROSS	MARCA	MILLARD
263104A000	HYUNDAI	ML-42040
263104A000	KIA	ML-42040
263104A010	HYUNDAI	ML-42040
263104A010	KIA	ML-42040
2631145001	HYUNDAI	ML-6355
263304X000	HYUNDAI	ML-42040
263304X000	KIA	ML-42040
264030	SAVARA	ML-8
2647019	CHRYSLER	ML-88227
2647019	CHRYSLER	ML-8
2650396	CHRYSLER	ML-16
26540347	MASSEY FERGUSON	ML-8
26540347	PERKINS	ML-8
2654342	MASSEY FERGUSON	ML-8
2654343	PERKINS	ML-8
26543436	MASSEY FERGUSON	ML-8
2654347	MASSEY FERGUSON	ML-8
2654347	PERKINS	ML-8
2654400	MASSEY FERGUSON	ML-8
2654401	MASSEY FERGUSON	ML-8
2654401	PERKINS	ML-8
2654403	KOMATSU	ML-8
2654412	PERKINS	ML-8
2700218	HYMAC	ML-8
27088234	WHITE	ML-8
27133843	VW GROUP	MK-3660
27133843	VW GROUP	MK-3660
2720E4601A	FORD	ML-88227
2720E4601A	FORD	ML-8
2720E6714A	FORD	ML-16
2724E6714A	FORD	ML-16
2724E6714B	FORD	ML-16
2724E6714C	FORD	ML-16
272E6714A	FORD	ML-88227
272E6714A	FORD	ML-8
2754360M1	MANITOU	ML-8
27701006374	RENAULT TRUCKS	ML-8
279009130104	FORD	MK-5682
2806201	CHRYSLER	ML-88227
2806201	CHRYSLER	ML-8
281111C000	HYUNDAI	MK-24086
2811302750	HYUNDAI	MK-29058
2811308000	HYUNDAI	MK-8000
2811308000	KIA	MK-8000

CROSS	MARCA	MILLARD
281130X000	HYUNDAI	MK-38183
281130X500	HYUNDAI	MK-38183
2811314000	KIA	MK-26123
281131C000	HYUNDAI	MK-24086
281131G000	HYUNDAI	MK-26123
281131G000	KIA	MK-26123
281131G100	HYUNDAI	MK-26123
281131R100	HYUNDAI	MK-68338
281131V100	HYUNDAI	MK-68338
2811322600	HYUNDAI	MK-8970
281132D000	HYUNDAI	MK-9392
281132D001	HYUNDAI	MK-9392
281132D001	KIA	MK-9392
281132F000	HYUNDAI	MK-9392
281132F000	KIA	MK-9392
281132G000	KIA	MK-76429
2811332510	HYUNDAI	MK-6362
2811344000	HYUNDAI	MK-253
281134H000	HYUNDAI	MK-25252
281130X000	HYUNDAI	MK-38183
281130X500	HYUNDAI	MK-38183
28115351	VW GROUP	ML-5552
28115351	VW GROUP	ML-5552
28115351	VW GROUP	ML-5552
2813044000	HYUNDAI	MK-253
2813045000	HYUNDAI	MK-253
28482801	FIAT	MF-5030
2862642	MASSEY FERGUSON	ML-8
291155615	VW GROUP	ML-3614
2951957	CHRYSLER	ML-88227
2951957	CHRYSLER	ML-8
297865	HYSTER	ML-8
2C5Z9155AA	FORD	MF-1083
2C5Z9155BC	FORD	MF-1083
2D0201051	VW GROUP	MF-5030
2E0129620B	VW GROUP	MK-93235
2E0129620D	VW GROUP	MK-93235
2H0127401	VW GROUP	MK-93235
2L2Z9155AB	FORD	MF-1036
2M5Z9155CA	FORD	MF-986
2NIU9601CB	FORD	MK-7020
2S619601CA	FORD	MK-15920
2S619601CA	MAZDA	MK-15920
2S6H16N619AA	FORD	MC-16462

CROSS	MARCA	MILLARD
30020673	GM	MF-5982
30115561AB	VW GROUP	ML-5548
30302	EICHER	ML-8
30302	MASSEY FERGUSON	ML-8
3051335111	VW GROUP	MF-5030
30758012	MONARK	ML-8
30758061	MONARK-DIESEL	ML-8
30758063	MONARK-DIESEL	ML-8
30758898	MONARK	ML-8
30758898	MONARK-DIESEL	ML-8
30A4000100	MITSUBISHI	ML-3593
30A4000101	MITSUBISHI	ML-3593
30A4000102	MITSUBISHI	ML-3593
30A4000201	MITSUBISHI	ML-6607
313658	CATERPILLAR	ML-8
313658	TOWMOTOR	ML-8
3141914	RENAULT	ML-8
3141914	RENAULT TRUCKS	ML-8
314361	CATERPILLAR	ML-8
314361	TOWMOTOR	ML-8
314914	RENAULT	ML-8
3153230	AMC FILTERS	ML-8
3170100	FALCOS	ML-8
31725L1000	NISSAN	ML-3614
3191028300	HYUNDAI	MF-3541
3191028300AT	HYUNDAI	MF-3541
3191105000	HYUNDAI	MF-25248
3191125000	HYUNDAI	MF-90122
3191129000	HYUNDAI	MF-9000
3191134000	HYUNDAI	MF-6680
3191134000AT	HYUNDAI	MF-6680
3194000000	HYUNDAI	MF-90122
3194025000	HYUNDAI	MF-90122
3194544001	HYUNDAI	MF-4886
3197044000	HYUNDAI	MF-4886
3197344000	HYUNDAI	MF-4886
3197344001	HYUNDAI	MF-4886
3197344100	HYUNDAI	MF-4886
319734F000	HYUNDAI	MF-4886
32414300	MAZDA	ML-6607
32414300	MAZDA	ML-3593
326701262071	TOYOTA	ML-3614
329060	CATERPILLAR	ML-8
329060	TOWMOTOR	ML-8

CROSS	MARCA	MILLARD
3321582	FORD	MF-3521
337133511A	VW GROUP	MF-5738
339	CROSLAND	ML-8
3396825	FORD	ML-3593
3448991	OPEL	ML-8
3448992	OPEL	ML-8
3500S	KS KOLBENSCHMIDT	ML-8
35115561	VW GROUP	ML-5552
3521840	FORD	ML-3593
35303692	INGERSOLL-RAND	ML-8
35366681	INGERSOLL-RAND	ML-8
3549957	CHRYSLER	ML-16
3563591	RENAULT TRUCKS	ML-8
35A5533	MINNEAPOLIS	ML-8
3618544	BENATI	ML-8
36198620	VW GROUP	MK-9015
36198620	VW GROUP	MK-9015
364464	CATERPILLAR	ML-8
364464	TOWMOTOR	ML-8
3652059	FORD	ML-3600
3652061	FORD	ML-2
369256	MASSEY FERGUSON	ML-8
37023802	MAZDA	ML-6607
37023802	MAZDA	ML-3593
37023803	MAZDA	ML-6607
37023803	MAZDA	ML-3593
37064000	ALFA ROMEO	ML-8
370640000	ALFA ROMEO	ML-8
3707442	FORD	ML-88227
3707442	FORD (EUROPE)	ML-8
37115561	VW GROUP	ML-5552
3732020	FORD	MF-800
3752039250	SENNEBOGEN	ML-8
377133511A	VW GROUP	MF-5738
3803268	FORD	ML-3593
388227	IHC / CASE IH	ML-8
388227R1	IHC / CASE IH	ML-8
388227R91	IHC / CASE IH	ML-8
3885284	FORD	MK-5682
3891893	FORD	ML-3593
3897991	VW GROUP	ML-16
3897991	VW GROUP	ML-16
3897992	VW GROUP	ML-16
3897992	VW GROUP	ML-16



CROSS	MARCA	MILLARD
3904728	FORD	ML-2
3908615	HYUNDAI	ML-3976
3917694	FORD	ML-88227
3917694	FORD (EUROPE)	ML-8
3936569	VW GROUP	ML-16
3936569	VW GROUP	ML-16
3936608	VW GROUP	ML-3614
3936870	VW GROUP	ML-16
3936870	VW GROUP	ML-16
3938626	VW GROUP	ML-16
3945577	VW GROUP	ML-5552
3947506	FORD	ML-88227
395267	VW GROUP	MF-5030
3963373	VW GROUP	ML-3614
3963373	VW GROUP	ML-3614
3964918	FORD	MF-986
3967423	VW GROUP	ML-16
3969209	VW GROUP	ML-5552
3C0129620	VW GROUP	MK-35495
3C0129620A	VW GROUP	MK-69754
3C0129620	VW GROUP	MK-35495
3M216744AA	FORD	ML-9463
3M519601AA	FORD	MK-5056
3M5Q6744AA	FORD	ML-9814
3W7E6714AA	FORD	ML-2
40065300	HATZ	ML-8
40065300989	HATZ	ML-8
4014	TEHO FILTER	ML-8
401503037071	TOYOTA	ML-16
40210	INGERSOLL-RAND	ML-8
4024213	FORD	MF-4922
405416136	CASE	ML-8
4056773	FORD	MK-8997
4060718	STEYR-DAIMLER-PUCH	ML-8
4060757	STEYR-DAIMLER-PUCH	ML-8
4089	TEHO FILTER	ML-8
409070036	STEYR-DAIMLER-PUCH	ML-8
4090736	STEYR-DAIMLER-PUCH	ML-8
410077732	MAZDA	MC-12021
410351032	INGERSOLL-RAND	ML-8
410423	BECK/ARNLEY	ML-8
4105409	CHRYSLER	ML-3614
410647	BECK/ARNLEY	ML-8
41170000	CARELLO	ML-8

CROSS	MARCA	MILLARD
41171000	CARELLO	ML-8
4119015	FIAT	ML-88227
4119015	FIAT	ML-8
4121392	FIAT	ML-88227
4121392	FIAT	ML-8
4126435	FIAT	ML-16
4134473	FAUN	ML-8
4137784	FORD	ML-2
41385000	CARELLO	ML-8
41416000	CARELLO	ML-8
415203002	TOYOTA	ML-3614
415203002	TOYOTA	ML-3614
415231050	TOYOTA	ML-44155
415231090	TOYOTA	ML-44155
415231090	TOYOTA	ML-44155
415231110	TOYOTA	ML-44155
415237010	TOYOTA	ML-96796
415238020	TOYOTA	ML-12027
415240060	TOYOTA	ML-96796
415251010	TOYOTA	ML-12027
415264010	TOYOTA	ML-3614
4158728	FIAT	ML-16
4160703	FIAT	ML-16
41702000	CARELLO	ML-8
4170601	FIAT	ML-88227
4170601	FIAT	ML-8
418038	BECK/ARNLEY	ML-8
418039	BECK/ARNLEY	ML-8
418156	BECK/ARNLEY	ML-8
418719	VOLVO	ML-8
4199523	FIAT	ML-16
4212109	FIAT	ML-3614
4213583	CHRYSLER	MK-3660
4213583	GM	MK-3660
4228326	FIAT	ML-3614
423476010	TOYOTA	MF-4922
423476010	TOYOTA	MF-4922
4241042	CHRYSLER	MK-3660
42511834	DAIHATSU	ML-8
4278859	FIAT-HITACHI	ML-8
4286050	FIAT	ML-16
4286051	FIAT	ML-16
4286052	FIAT	ML-16
4294841	FIAT	ML-3593

CROSS	MARCA	MILLARD
430143	VOLVO	ML-8
4301438	VOLVO	ML-8
431010	DONIT	ML-8
431026	DONIT	ML-8
431087	DONIT	ML-8
431133511D	VW GROUP	MF-3747
4312114	VW GROUP	MF-6400
4312114	VW GROUP	MF-6400
4316238	FIAT	ML-16
4323062	FIAT	ML-16
4335580	FIAT	ML-16
4335880	FIAT	ML-16
4339509	FIAT	ML-3614
4342800	CHRYSLER	MK-3660
4343591	FIAT	ML-16
4343597	FIAT	ML-16
43465	LEROI	ML-8
4354828	FIAT	ML-88227
4354828	FIAT	ML-8
4356500	FIAT	ML-3614
4363484	FIAT	ML-3614
4363485	FIAT	ML-16
4371581	FIAT	ML-3614
4382101	FIAT	ML-3682
439	CROSLAND	ML-8
4394463	FIAT	ML-3682
43944630	FIAT	ML-3682
4403318	FORD	MF-4922
441043121196	VW GROUP	MF-6400
44107019	VW GROUP	ML-3614
441201511B	VW GROUP	MF-3747
441201511C	VW GROUP	MF-3747
441204511C	VW GROUP	MF-3747
443133511	VW GROUP	MF-3744
4434790	FIAT	ML-3682
4434791	FIAT	ML-3614
4434792	FIAT	ML-3682
4435104	FIAT	MF-5030
4435144	FIAT	MF-6400
4442554	FIAT	MF-5030
4442559	FIAT	MF-5030
4449040	VW GROUP	ML-16
4449040	VW GROUP	ML-16
4454116	FORD	ML-3600

CROSS	MARCA	MILLARD
4469396	FIAT	ML-3614
4469397	FIAT	ML-3614
4469398	FIAT	ML-3614
4469399	FIAT	ML-3614
4469400	FIAT	ML-3614
447133511	VW GROUP	MF-3744
4504651	VOLVO	ML-8
4506839	FIAT	ML-88227
4506839	FIAT	ML-8
451103063	BOSCH	ML-8
451103185	BOSCH	ML-8
451103253	BOSCH	ML-8
451103256	BOSCH	ML-8
451103313	BOSCH	ML-8
451103346	BOSCH	ML-8
451103357	BOSCH	ML-8
451103906	BOSCH	ML-8
451104001	BOSCH	ML-8
451104003	BOSCH	ML-8
451104063	BOSCH	ML-8
451104065	BOSCH	ML-8
451104511	BOSCH	ML-8
45115466	VW GROUP	ML-9463
45115466	VW GROUP	ML-9463
4511629	ALLIS CHALMERS	ML-8
45116290	ALLIS CHALMERS	ML-8
45116292	ALLIS CHALMERS	ML-8
45118466	VW GROUP	ML-9463
45118466	VW GROUP	ML-9463
451203005	BOSCH	ML-8
451203007	BOSCH	ML-8
451203008	BOSCH	ML-8
451203012	BOSCH	ML-8
451203059	BOSCH	ML-8
451203061	BOSCH	ML-8
451203088	BOSCH	ML-8
451203153	BOSCH	ML-8
451203176	BOSCH	ML-8
45170000	ALFA ROMEO	ML-8
451700000	ALFA ROMEO	ML-8
4523873	FIAT	ML-88227
4523873	FIAT	ML-8
453	MAZDA	MK-4939
4628534	FORD	ML-2

CROSS	MARCA	MILLARD
4630787	ALLIS CHALMERS	ML-8
46402457	FIAT	ML-5566
46403932	FIAT	MF-618
46403933	FIAT	MF-618
46423474	FIAT	ML-5566
46441236	FIAT	MF-618
46468378	FIAT	ML-5566
46474249	FIAT	MF-618
46519728	FIAT	ML-5566
46523087	FIAT	MF-618
46544828	FIAT	ML-5566
46751179	FIAT	ML-3593
46769601	FIAT	MF-618
46795125	FIAT	ML-5552
46796687	FIAT	ML-5796
46805828	FIAT	ML-3614
46805830	FIAT	ML-3682
46805832	FIAT	ML-5566
4720364	CHRYSLER	ML-5552
4778838	CHRYSLER	ML-5552
4781452AA	CHRYSLER	ML-3600
4787410	FIAT	ML-4847
4804651	VOLVO	ML-8
4861041	CHRYSLER	MK-3660
4864307	CHRYSLER	MF-1680
4891097AA	CHRYSLER	MK-8805
4891694AA	CHRYSLER	MK-10118
4891695AA	DODGE	MK-10118
4897244AA	CHRYSLER	MF-1582
489914300	MAZDA	ML-6607
489OS	FIAT	ML-3593
4910810	ALLIS CHALMERS	ML-8
49133843	VW GROUP	MK-3660
49133843	VW GROUP	MK-3660
494133	DAF	ML-8
498401	DAF	ML-8
4A0133511	VW GROUP	MF-3744
4L3Z9601BA	FORD	MK-9687
4L5Z9155AA	FORD	MF-1036
4M5Q6714CA	FORD	ML-5566
4R3Z9601AA	FORD	MK-9895
5000040870	RENAULT TRUCKS	ML-8
5000044059	RENAULT TRUCKS	ML-8
5000044064	RENAULT TRUCKS	ML-8

CROSS	MARCA	MILLARD
5000044487	RENAULT TRUCKS	ML-8
5000044499	RENAULT TRUCKS	ML-8
5000044959	RENAULT TRUCKS	ML-8
5000184	FORD	ML-5552
5000185	FORD	ML-16
5000187	FORD	ML-16
5000188	FORD	ML-13
5000189	FORD	ML-88227
5000189	FORD (EUROPE)	ML-8
5000277	FORD	ML-3387
50004480	FORD	ML-3614
5000480	FORD	ML-3614
5000513	FORD	ML-88227
5000513	FORD (EUROPE)	ML-8
5000686625	RENAULT TRUCKS	ML-8
5000860	FORD	ML-16
5000862	FORD	ML-88227
5000862	FORD (EUROPE)	ML-8
5001025	FORD	ML-88227
5001123	FORD	ML-88227
5001248	FORD	ML-16
50013350	KS KOLBENSCHMIDT	ML-8
50013514	KS KOLBENSCHMIDT	ML-8
5002230	FORD	ML-16
5002453	FORD	ML-3387
5002455	FORD	ML-3614
5002459	FORD	ML-3387
5002530	FORD	ML-3614
50032275	TARGA SERVICE	ML-8
5003329	FORD	ML-3614
5003331	FORD	ML-3614
5003460	FORD	ML-5552
5003461	FORD	ML-5552
5003559	FORD	ML-16
5003560	FORD	ML-16
5003561	FORD	ML-16
5003914	FORD	ML-3614
5003929	FORD	ML-3614
5003930	FORD	ML-3614
5003932	FORD	ML-16
5003967	FORD	ML-3614
5003968	FORD	ML-3614
5004552	FORD	ML-88227
5004747	FORD	ML-5552

CROSS	MARCA	MILLARD
5004775	FORD	ML-88227
5004776	FORD	ML-88227
5004776	FORD	ML-88227
5004776	FORD	ML-88227
5004776	FORD (EUROPE)	ML-8
5004926	FORD	ML-3614
5004928	FORD	ML-5552
5004929	FORD	ML-5552
5004930	FORD	ML-3614
5005097	FORD	ML-16
5005572	FORD	ML-3614
5005573	FORD	ML-3614
5005631	FORD	ML-88227
5005631	FORD (EUROPE)	ML-8
5005805	FORD	ML-16
5006224	FORD	MK-3660
5006227	FORD	ML-5796
5006946	FORD	ML-16
5006951	FORD	ML-5552
5007124	FORD	ML-5552
5007165	FORD	ML-4952
5007365	FORD	ML-5552
5007366	FORD	ML-5552
5008589	FORD	ML-3614
5008677	FORD	ML-16
5008718	FORD	ML-3614
5008720	FORD	ML-3614
5008721	FORD	ML-3614
5008722	FORD	ML-3614
5009063	FORD	MK-3660
5009087	FORD	ML-3614
5009088	FORD	ML-3614
5009231	FORD	ML-88227
5009231	FORD (EUROPE)	ML-8
5009232	FORD	ML-88227
5009285	FORD	ML-3387
5009419	FORD	ML-3387
5010292	FORD	ML-4967
5010665	FORD	ML-16
5010912	FORD	MF-6400
5011312	FORD	MK-253
5011417	FORD	ML-49
5011502	FORD	ML-49
5011546	FORD	MK-253

CROSS	MARCA	MILLARD
5011780	FORD	ML-3614
5011782	FORD	ML-3614
5011788	FORD	ML-5566
5011838	FORD	ML-88227
5011838	FORD (EUROPE)	ML-8
5011991	FORD	ML-5566
5011997	FORD	ML-3614
5012000	FORD	ML-3614
5012035	FORD	ML-16
5012040	FORD	ML-16
5012551	FORD	ML-3682
5012554	FORD	ML-88227
5012554	FORD (EUROPE)	ML-8
5012555	FORD	ML-3682
5012556	FORD	ML-5552
5012575	FORD	ML-3682
5012580	FORD	ML-88227
5012580	FORD (EUROPE)	ML-8
5012645	FORD	ML-4967
5012651	FORD	ML-5552
5013143	FORD	ML-3614
5013146	FORD	ML-16
5013147	FORD	ML-3387
5013148	FORD	ML-88227
5013319	FORD	ML-3614
5013388	FORD	ML-5796
5013389	FORD	ML-5796
5014055	FORD	ML-16
5014515	FORD	ML-16
5016714	FORD	ML-5796
5016715	FORD	ML-5796
5016785	FORD	ML-5796
5016786	FORD	ML-3387
5016955	FORD	ML-3682
5016956	FORD	ML-5796
5016957	FORD	ML-16
5016958	FORD	ML-3593
5016960	FORD	ML-88227
5016960	FORD (EUROPE)	ML-8
5016962	FORD	ML-88227
5017317	FORD	ML-5796
5017319	FORD	ML-5796
5017809	FORD	ML-3614
5017811	FORD	ML-3614

CROSS	MARCA	MILLARD
5017853	FORD	MK-5929
5018028	FORD	ML-5552
5018035	FORD	MF-5030
5018351	FORD	ML-88227
5018353	FORD	ML-3682
5018355	FORD	ML-16
5018777AA	CHRYSLER	MK-18777
5018777AB	CHRYSLER	MK-18777
5019408	FORD	MK-5107
5019424	FORD	ML-88227
5019425	FORD	ML-88227
5019918	FORD	ML-3682
5020120	FORD	ML-4952
5020405	FORD	MF-3744
5020406	FORD	MF-3744
5020700025	VW GROUP	ML-3614
5022736	FORD	MF-800
5022748	FORD	MK-5301
5022749	FORD	MK-5301
5022797	FORD	ML-88227
5022799	FORD	ML-3682
5024424	FORD	ML-16
5025071	FORD	MK-43080
5025078	FORD	MK-7421
5025082	FORD	MK-43080
5025089	FORD	ML-4847
5025091	FORD	ML-4847
5025092	FORD	ML-4967
5025101	FORD	MF-5138
5025102	FORD	MF-4886
5025104	FORD	MF-4922
5025106	FORD	MF-800
5025133	FORD	ML-88227
5025133	FORD (EUROPE)	ML-8
5025136	FORD	MK-5107
5029851	FORD	MK-3916
5042621	TALBOT	ML-8
507631	FIAT	ML-3593
5086301AA	CHRYSLER	ML-9090
5092555	FORD	ML-88227
5092557	FORD	ML-88227
5102905AA	CHRYSLER	ML-9090
5102905AB	CHRYSLER	ML-9090
510313	FIAT	ML-3614

CROSS	MARCA	MILLARD
510889	FIAT	ML-3614
51191	WIX	ML-8
5119662	FORD	MF-4922
5120700509	VW GROUP	ML-5552
5141522	GM	MK-253
51452	WIX	ML-8
51460	WIX	ML-8
5140S	KS KOLBEN-SCHMIDT	ML-8
515027	DEMAG	ML-8
51502700	DEMAG	ML-8
5151017	RENAULT TRUCKS	ML-8
515141300	YALE	ML-8
51515	WIX	ML-8
51525	WIX	ML-8
5162051	FORD	MK-8997
51773	WIX	ML-8
51775	WIX	ML-8
51806	WIX	ML-8
5189933AA	CHRYSLER	MK-16246
5191624	FORD	ML-88227
5198871	GM	MK-253
5198872	GM	MK-253
52100283AC	CHRYSLER	MF-283
52100402AE	CHRYSLER	MF-74058
52100402AF	CHRYSLER	MF-74058
521824	MACO-MEUDON	ML-8
5221272	TALBOT	ML-8
5221313	CHRYSLER	ML-88227
5221313	CHRYSLER	ML-8
5221313	TALBOT	ML-8
5223103	CITROËN	ML-8
5278097	CHRYSLER	MF-1582
5278097AB	CHRYSLER	MF-1582
5281090	CHRYSLER	ML-16
5281090	CHRYSLER	ML-3614
53004383	CHRYSLER	MK-3901
53007386	CHRYSLER	MK-7440
53007386AB	CHRYSLER	MK-7440
53030688	CHRYSLER	MK-7440
53032404AA	CHRYSLER	MK-9401
530388	FIAT	ML-3614
532	CROSLAND	ML-8
534372	FIAT	ML-3614
5366340325	SCHAEFF	ML-8

CROSS	MARCA	MILLARD
5406242	CITROËN	ML-8
5457752	CITROËN	ML-8
54577525	CITROËN	ML-8
5457752S	CITROËN	ML-8
54577752S	CITROËN	ML-8
5502094	LIEBHERR	ML-8
55183307	FIAT	MK-25270
55230822	FIAT	ML-3593
55256470	FIAT	ML-3593
55353324	CHEVROLET	ML-19626
55353324	GM	ML-19626
55355096	GM	MK-9391
5537	LUCAS (LUCAS-TRW)	ML-8
554329	LEYLAND	ML-8
555329	LEYLAND	ML-8
55556465	GM	MK-5970
55560202	GM	ML-3614
55594651	GM	ML-19626
5574459	GM	ML-88227
5574459	GM	ML-8
5575840	GM	ML-88227
5575840	GM	ML-8
5578052	GM	ML-13
5578085	GM	ML-13
5578108	GM	ML-13
5579970	GM	ML-88227
5579970	GM	ML-8
5570S	KS KOLBEN-SCHMIDT	ML-8
558000303	BOGE	ML-8
56115561	VW GROUP	ML-5552
561155611	VW GROUP	ML-5552
561155612	VW GROUP	ML-5552
57115561	VW GROUP	ML-5552
571958	LANCER BOSS	ML-8
5721190	CLAAS	ML-8
574184	AP LOCKHEED	ML-8
58133843	FORD	MK-5107
58133843	VW GROUP	MK-5107
58133843	VW GROUP	MK-5107
581473	PEGASO	ML-8
59030255	FIAT	ML-20004
59115561	VW GROUP	ML-5552
59133843	VW GROUP	MK-5107
59133843	VW GROUP	MK-5107

CROSS	MARCA	MILLARD
592602	FIAT	ML-88227
592602	FIAT	ML-8
5926021	FIAT	ML-88227
5926021	FIAT	ML-8
592765	FIAT	ML-88227
592765	FIAT	ML-8
5939831	FIAT	ML-3682
5939832	FIAT	ML-3614
5940898	VW GROUP	ML-16
5940898	VW GROUP	ML-16
5951685	FIAT	ML-16
5951865	FIAT	ML-3682
5951891	FIAT	ML-16
5964796	FIAT	ML-16
5984093	FIAT	MF-6400
59LK6714A	FOMOCO	ML-8
5C0129620	VW GROUP	MK-69754
5L1Z9155AA	FORD	MF-986
5X0201511	VW GROUP	MF-5738
5Z0129620A	VW GROUP	MK-9431
6000141020	RENAULT AGRI	ML-8
6002115214	KOMATSU	ML-8
6041176	FORD	ML-3614
60504569	FIAT	ML-3614
60506968	FIAT	MF-3747
60507080	FIAT	ML-16
60507213	FIAT	ML-88227
60523432	FIAT	MF-5030
60534120	FIAT	MF-6400
60541180002	KOMATSU	ML-8
605411880002	MWM	ML-8
605417880002	MWM	ML-8
60565	MERCURISER	ML-8
6057166	FORD	ML-3614
6057167	FORD	ML-3614
60574554	FIAT	ML-3614
60585533	FIAT	MF-3747
6061629	FORD	ML-88227
6061629	FORD (EUROPE)	ML-8
60621830	FIAT	ML-5566
60621890	FIAT	ML-5566
6063340	FORD	ML-16
6066094	FORD	ML-3614
6066095	FORD	ML-3614

CROSS	MARCA	MILLARD
6066096	FORD	ML-3614
60675978	FIAT	MF-618
60718204	ALFA ROMEO	ML-8
60800097	FIAT	MF-5030
60801979	FIAT	MF-3747
60810503	FIAT	MF-3747
60810709	FIAT	ML-3682
60810852	FIAT	ML-5566
60811822	FIAT	MF-618
60811904	FIAT	MF-618
60812738	FIAT	MF-618
60814435	FIAT	ML-5566
6100448	CHRYSLER	ML-88227
6100448	CHRYSLER	ML-8
6103279	FORD	MF-3744
61115561	VW GROUP	ML-88227
61142254	FIAT	ML-88227
61200	MAPCO	ML-8
6126291	FIAT	MF-5030
6141811	FORD	ML-3614
6160448	TALBOT	ML-8
6162293	FORD	MK-3916
61657203	FIAT	ML-88227
6180522	FORD	MK-5357
62703506	FIAT	ML-88227
62703506	FIAT	ML-8
62775369	FIAT	ML-88227
62775369	FIAT	ML-8
630	CROSLAND	ML-8
63234	MANITOU	ML-8
637	CROSLAND	ML-8
640	CROSLAND	ML-8
6424691	GM	MK-253
643	CROSLAND	ML-8
6435675	GM	ML-88227
6435675	GM	ML-8
6435679	GM	ML-13
6436749	GM	ML-88227
6436749	GM	ML-8
6437055	GM	ML-13
6437946	GM	ML-13
6438121	GM	ML-88227
6438121	GM	ML-8
6438162	GM	ML-3614

CROSS	MARCA	MILLARD
6438384	GM	ML-13
6439354	GM	ML-5796
6439392	GM	ML-49
6439681	GM	ML-88227
6439681	GM	ML-8
6439929	GM	ML-3387
6442	LUCAS (LUCAS-TRW)	ML-8
64511629	ALLIS CHALMERS	ML-8
6458B1	INGERSOLL- RAND	ML-8
650362	OPEL	ML-8
650372	OPEL	ML-8
650385	OPEL	ML-8
6536	CHRIS-CRAFT	ML-8
6553450	GM	MK-8732
6594603	FORD	MF-3526
6612598	VOLVO	ML-8
66125980	VOLVO	ML-8
6636968	FORD	ML-2
6688744	FORD	MF-3744
6780358166	VW GROUP	ML-88227
6780358166	VW GROUP	ML-8
68001297AA	CHRYSLER	ML-9463
68115561	VW GROUP	ML-88227
68115561	LINDE	ML-8
68115561	VW GROUP	ML-8
681155613	VW GROUP	ML-88227
681155613	VW GROUP	ML-8
68521824	SULLAIR	ML-8
690X6A692RA	FORD	ML-3614
692M6714AA	FORD	ML-16
6937011	FORD	ML-3600
694229	CATERPILLAR	ML-8
694229E	CATERPILLAR	ML-8
6C119601CB	FORD	MK-73667
6C1Q6744AA	FORD	ML-9814
6C1Q6744BA	FORD	ML-9814
6E5Z9601GA	FORD	MK-19158
6G9N6744BA	FORD	ML-14120
6G9Q6744AA	FORD	ML-9814
6K0129601E	VW GROUP	MK-5377
6K0129607K	VW GROUP	MK-5377
6K0129607M	VW GROUP	MK-5377
6K0129607R	VW GROUP	MK-5377
6K0129607T	VW GROUP	MK-5377

CROSS	MARCA	MILLARD
6K0129620B	VW GROUP	MK-8995
6K0129601E	VW GROUP	MK-5377
6K0129607M	VW GROUP	MK-5377
6K0129607R	VW GROUP	MK-5377
6K0129607T	VW GROUP	MK-5377
6L2Z9601AA	FORD	MK-1780
6M5G6744AA	FORD	ML-14120
6N020121I	VW GROUP	MF-6400
6N020151I	VW GROUP	MF-6400
6N0201511A	VW GROUP	MF-6400
6N020151I	VW GROUP	MF-6400
6N0201511A	VW GROUP	MF-6400
6Q0129620	VW GROUP	MK-9431
6Q0129620A	VW GROUP	MK-9431
6Q0129620B	VW GROUP	MK-9431
6Q01296620	VW GROUP	MK-9431
6Q020105I	VW GROUP	MF-74120
6Q0201051B	VW GROUP	MF-74120
6Q0201051H	VW GROUP	MF-74120
6Q0201051J	VW GROUP	MF-74120
6Q020151I	VW GROUP	MF-1051
6Q0201511A	VW GROUP	MF-1051
6Q0201511B	VW GROUP	MF-74120
6Q0201512	VW GROUP	MF-74120
6Q0819653	VW GROUP	MC-9323C
6Q0819653B	VW GROUP	MC-9323C
6Q0820367	VW GROUP	MC-9323C
6Q0820367A	VW GROUP	MC-9323C
6Q0820367B	VW GROUP	MC-9323C
6R0820367	VW GROUP	MC-9323C
6U0129620	VW GROUP	MK-5377
6U0201511D	VW GROUP	MF-6400
6V0201511D	VW GROUP	MF-6400
6X020151I	VW GROUP	MF-618
6X0201511B	VW GROUP	MF-618
6X0201511B	VW GROUP	MF-618
700003200I	KUBOTA	ML-8
70115561	VW GROUP	ML-3600
70115561	VW GROUP	ML-3600
70115562	VW GROUP	ML-9463
70237000	FIAT	ML-88227
70237000	ALLIS CHALMERS	ML-8
70237000	FIAT	ML-8
70243163	FIAT	MK-253

CROSS	MARCA	MILLARD
70248882	FIAT	MK-253
7032389	FIAT	ML-16
7072637	FORD	ML-88227
7075753	FIAT	ML-5566
70HM6714AA	FORD	ML-16
70HM6714BB	FORD	ML-16
71115562	VW GROUP	ML-9463
71115562	VW GROUP	ML-9463
71167808	FIAT	MK-253
7121071142	STEYR- DAIMLER-PUCH	ML-8
71711048	FIAT	MF-6400
71713782	FIAT	ML-4847
71718765	FIAT	ML-4847
71734217	FIAT	ML-4847
71736100	FIAT	MF-618
71736101	FIAT	MF-6400
71736102	FIAT	MF-6400
71736107	FIAT	MF-3747
71736110	FIAT	MF-3747
71736121	FIAT	MK-7421
71736151	FIAT	MK-5595
71736158	FIAT	ML-5566
71736159	FIAT	ML-5566
71736162	FIAT	ML-3614
71736163	FIAT	ML-4847
71736166	FIAT	ML-3614
71736170	FIAT	ML-16
71736171	FIAT	ML-88227
71739396	FIAT	ML-9018
71739633	FIAT	ML-4847
71739634	FIAT	ML-4847
7174020	FIAT	MF-3747
71744410	FIAT	ML-19626
71746975	FIAT	MF-2000
71752468	FIAT	ML-9018
71753740	FIAT	ML-4847
71753742	FIAT	ML-5796
71753841	FIAT	MF-2000
71765459	FIAT	ML-3593
71769199	FIAT	ML-9018
71775180	CHRYSLER	ML-9090
71881	UNITEC	ML-8
7212351	FORD	MF-5030
7235007	FORD	MF-3526

CROSS	MARCA	MILLARD
72370000	FIAT	ML-88227
72370000	ALLIS CHALMERS	ML-8
72370000	FIAT	ML-8
72G	GREYFRIARS	ML-8
7300943	FIAT	ML-16
7301916	FIAT	ML-4847
731094	VOLVO	ML-8
73194	VOLVO	ML-8
73500506	FIAT	ML-5796
73502069	FIAT	MK-25270
74115561	VW GROUP	ML-88227
74115561	VW GROUP	ML-88227
74434793	FIAT	ML-20004
74434794	FIAT	ML-20004
74434794	FIAT	ML-3614
74446335	FIAT	ML-20004
74511629	FIAT	ML-88227
74511629	FIAT	ML-8
74630787	FIAT	ML-88227
74630787	FIAT	ML-8
74700130	NISSAN	MF-5138
74907795	FIAT	MK-253
74910810	ALLIS CHALMERS	ML-8
74HM6714BA	FORD	ML-88227
74HM6714CA	FORD	ML-16
74HM6714CB	FORD	ML-16
75061409	TALBOT	ML-8
75061411	TALBOT	ML-8
75065049	TALBOT	ML-8
75065702	RENAULT TRUCKS	ML-8
75115561	VW GROUP	ML-88227
7524505	FIAT	ML-16
7558338	FIAT	MK-5595
75583381	FIAT	MK-5595
7567464	FIAT	MF-6400
7571543	FIAT	ML-5566
7571569	FIAT	ML-4847
7574020	FIAT	MF-3747
7581562	FIAT	ML-3682
75DU6714B1	FORD	ML-16
7604770	FIAT	ML-5566
76052849	HOFFER	ML-8
7612972	FIAT	MF-6400
761F9601AA	FORD	MK-253

CROSS	MARCA	MILLARD
7633139	FIAT	MK-7421
76331391	FIAT	MK-7421
76547883	FIAT	ML-3593
7680997	FIAT	MF-6400
7701002280	RENAULT TRUCKS	ML-8
7701006374	RENAULT TRUCKS	ML-8
7701022800	RENAULT TRUCKS	ML-8
7701029280	RENAULT	ML-8
7701415051	RENAULT	ML-8
77110590	FIAT	MF-5030
7719390	FIAT	MF-6400
7724167	FIAT	ML-3614
77281	GRAY	ML-8
77362340	FIAT	MF-2000
77363600	FIAT	MF-2000
77365864	FIAT	MF-2000
77365902	FIAT	MF-2000
7749305	FIAT	ML-16
77823802	MAZDA	ML-6607
77823802	MAZDA	ML-3593
77823802	MAZDA	ML-3593
7787063	FIAT	MF-6400
77BM6714C1A	FORD	ML-3614
77BM6714C2A	FORD	ML-3614
78115561	VW GROUP	ML-8
78TF9601BA	FORD	MK-5107
78TF9601BB	FORD	MK-5107
7910031245	FIAT	ML-5566
795097	VOLVO	ML-8
7950975	VOLVO	ML-8
7961367	GM	ML-16
7965051	GM	ML-3614
79756	GEHL	ML-8
7984225	GM	ML-16
7984229	GM	ML-16
7984235	GM	ML-16
7984256	GM	ML-3614
7984292	GM	ML-88227
7984303	GM	ML-88227
7984303	GM	ML-8
7984326	GM	ML-3682
7984366	GM	ML-16
7984460	GM	ML-88227
7984460	GM	ML-8

CROSS	MARCA	MILLARD
7984655	GM	ML-88227
7984717	GM	ML-88227
7984778	GM	ML-5552
7984844	GM	ML-88227
7984844	GM	ML-8
7988189	GM	ML-3614
7998968	GM	MK-253
7C3Z9601A	FORD	MK-95334
7T169601AA	FORD	MK-5929
7T169601AB	FORD	MK-5929
7T4Z9601A	FORD	MK-52045
7W2327	CATERPILLAR	ML-8
8004841	ORENSTEIN + KOPPEL	ML-8
8023398	KOEHRING	ML-8
80292S50A01	HONDA	MC-35422
80292S5A003	HONDA	MC-35422
80292S5DA01	HONDA	MC-35422
80292S6DG01	HONDA	MC-35422
80292S6M901	HONDA	MC-35422
80292SCAE11	HONDA	MC-35422
80292SCAG01	HONDA	MC-35422
811133511	VW GROUP	MF-3744
811133511A	VW GROUP	MF-800
811133511B	VW GROUP	MF-3744
811133511D	VW GROUP	MF-800
81113511	VW GROUP	MF-3744
811485	IMR / IMT	ML-8
81331180003	MAN	ML-8
817086	PEGASO	ML-8
817323802	MAZDA	ML-3593
8200033468	NISSAN	ML-5796
82220425	FIAT	ML-88227
82220425	FIAT	ML-8
8222045	FIAT	ML-88227
8222045	FIAT	ML-8
82232108	FIAT	ML-88227
82232108	FIAT	ML-8
82241613	FIAT	ML-88227
82241613	FIAT	ML-8
82255076	FIAT	ML-88227
82255076	FIAT	ML-8
82300672	FIAT	ML-88227
82300672	FIAT	ML-8
82342304	FIAT	MF-6400

CROSS	MARCA	MILLARD
82342881	FIAT	ML-16
82425329	FIAT	MF-3744
82GB9155AA	FORD	MF-3744
82GB9155BA	FORD	MF-3744
83064	HAKO	ML-8
834581	GM	MK-5496
8357790	VOLVO	ML-8
836064	MASSEY FERGUSON	ML-8
836064M91	MASSEY FERGUSON	ML-8
83984235	NEW HOLLAND	ML-8
857133511	VW GROUP	MF-3744
859129620	VW GROUP	MK-5301
85TF9600AA	FORD	MK-5107
85TF9600EA	FORD	MK-5107
860114932108	HANOMAG HENSCHEL	ML-8
86623802	MAZDA	ML-6607
86623802	MAZDA	ML-3593
86623802	MAZDA	ML-3593
8671002054	MOTRIO	ML-8
8671002058	MOTRIO	ML-8
870X6714UA	FORD	ML-16
870X9601CCA	FORD	MK-5107
870X9601RA	FORD	MK-5929
88055016002	MAN	ML-8
881304	MASSEY FERGUSON	ML-8
881304M91	MASSEY FERGUSON	ML-8
881446	MASSEY FERGUSON	ML-8
8890499	AMC FILTERS	ML-8
88983068	GM	MF-6397
88984215	GM	ML-4952
88CX9155BA	FORD	MF-3744
89001934	GM	MK-5970
89017524	GM	ML-10060
89028774	GM	MF-800
89028775	GM	MF-3521
89028776	GM	MF-4777
89028779	GM	MF-5237
89028781	GM	MF-5030
89028785	GM	MF-618
89028786	GM	MF-481
89028788	GM	MF-578
89028789	GM	MF-645A
89028790	GM	MF-580
890X9601JA	FORD	MK-5301

CROSS	MARCA	MILLARD
890X9601KA	FORD	MK-5301
89201808201	VW GROUP	ML-5552
89201808900	VW GROUP	ML-5552
892202003	TOYOTA	ML-4967
892202003	TOYOTA	ML-4967
892202005	TOYOTA	ML-4967
892202005	TOYOTA	ML-4967
892202011	TOYOTA	ML-3614
892202011	TOYOTA	ML-3614
893133511	VW GROUP	MF-3744
8953004383	CHRYSLER	MK-3901
897251943	GM	MK-51943
8994750	GM	MK-253
899839	CLARK	ML-8
89FF9601AA	FORD	MK-3916
8A0133511	VW GROUP	MF-3747
8D0133843	VW GROUP	MK-5107
8FG123802	MAZDA	ML-6607
8FG1238029A	MAZDA	ML-6607
8FG123803	MAZDA	ML-6607
8V219601A1A	FORD	MK-26934
8V219601AA	FORD	MK-26934
9000022105	BOSCH	ML-8
90027778	GM	ML-3614
9003569	FIAT	ML-88227
9004824	FIAT	ML-88227
900506401	EATON	ML-8
9006695	AVELING BARFORD	ML-8
9008091034	TOYOTA	ML-4967
9008091045	TOYOTA	ML-4967
9008091058	TOYOTA	ML-4967
900X6714	FORD	ML-4847
900X9601ALA	FORD	MK-7421
90110720302	PORSCHE	ML-8
90110720309	PORSCHE	ML-8
90169150	GM	MF-6400
90220955	GM	MK-5107
90220970	GM	MK-5107
9025229	GM	ML-92095
90284766	GM	MK-5107
9029	CROSLAND	ML-8
90322261	GM	MK-9015
90353562	GM	MF-618
903S	GREYFRIARS	ML-8

CROSS	MARCA	MILLARD
90411702	GM	MK-5496
90411703	GM	MK-5496
90411732	GM	MK-5496
90412779	GM	MK-5496
90412899	GM	MK-5496
90485456	GM	ML-3593
90485457	GM	ML-3593
90486292	GM	MF-618
90486296	GM	MK-5496
90486297	GM	MK-5496
90486298	GM	MK-5496
90486299	GM	MK-5496
90510934	GM	ML-3387
90510935	GM	ML-3387
90515TA001	TOYOTA	ML-4967
90531003	GM	MK-5970
90537280	GM	ML-9018
90541162	GM	ML-3593
90541163	GM	ML-3593
90542344	GM	ML-5552
90544191	GM	ML-9090
90570368	GM	ML-9090
9091503001	TOYOTA	ML-4967
9091503002	TOYOTA	ML-3614
9091503004	TOYOTA	ML-5166
9091503004	TOYOTA	ML-4967
9091503005	TOYOTA	ML-20004
9091510001	TOYOTA	ML-4967
9091510002	TOYOTA	ML-5166
9091510003	TOYOTA	ML-4967
9091510004	TOYOTA	ML-4967
9091520001	TOYOTA	ML-20004
9091520002	TOYOTA	ML-20004
9091520003	TOYOTA	ML-20004
9091520004	TOYOTA	ML-20004
9091533021	TOYOTA	ML-20004
9091540001	TOYOTA	ML-16
9091591058	TOYOTA	ML-4967
90915CA003	TOYOTA	ML-4967
90915TA001	TOYOTA	ML-4967
90915TA005	TOYOTA	ML-4967
90915TB001	TOYOTA	ML-20004
90915TB00100	TOYOTA	ML-3614
90915TD004	TOYOTA	ML-88227

CROSS	MARCA	MILLARD
90915YZZA3	TOYOTA	ML-4967
90915YZZB3	TOYOTA	ML-3614
90915YZZB6	TOYOTA	ML-20004
90915YZZC3	TOYOTA	ML-4967
90915YZZC5	TOYOTA	ML-4967
90915YZZC7	TOYOTA	ML-4967
90915YZZD1	TOYOTA	ML-3614
90915YZZD2	TOYOTA	ML-3614
90915YZZD3	TOYOTA	ML-3614
90915YZZD3	TOYOTA	ML-20004
90915YZZE1	TOYOTA	ML-4967
90915YZZF1	TOYOTA	ML-5166
90915YZZF2	TOYOTA	ML-4967
90915YZZG1	TOYOTA	ML-3614
90915YZZJ3	TOYOTA	ML-20004
90915YZZJ4	TOYOTA	ML-20004
910S	GREYFRIARS	ML-8
9110665	GM	ML-4847
9110718	GM	ML-5796
9111019	GM	ML-5796
91151707	GM	ML-3593
91151708	GM	ML-3593
91152027	GM	MK-5107
91152028	GM	MK-5107
91153945	GM	ML-5552
91155714	GM	MK-5970
91159804	GM	MF-5857
91159955	GM	MK-8964
9117321	GM	ML-9090
91174457	GM	MK-8069
9117557	GM	MK-5970
91181912	GM	MK-5970
9129747	GM	MK-9391
9146101500	MINI	MK-253
9146111500	MINI	MK-253
9153580780	FIAT	MF-5030
91559804	GM	MF-5857
91677369	INGERSOLL-RAND	ML-8
9177267	GM	MK-25270
918266R91	IHC / CASE IH	ML-8
918266R92	IHC / CASE IH	ML-8
918266R93	IHC / CASE IH	ML-8
9194405	GM	MK-9684
9194746	GM	ML-9018

CROSS	MARCA	MILLARD
9196120	GM	MK-9391
91FF9601AA	FORD	MK-5357
91FF9601AB	FORD	MK-5357
9201138	GM	MK-5970
9201158	GM	MK-5970
920203	IHC / CASE IH	ML-8
920203C1	IHC / CASE IH	ML-8
9202382	GM	MK-9684
92068246	GM	ML-3675
92128859	INGERSOLL-RAND	ML-8
92142003	GM	ML-3387
927787	WYLLIS	ML-8
92800311	SAVARA	ML-8
92801511	SAVARA	ML-8
92804117	SAVARA	ML-8
92805311	SAVARA	ML-8
92805317	SAVARA	ML-8
92822317	SAVARA	ML-8
92822383	SAVARA	ML-8
92823911	SAVARA	ML-8
92825017	SAVARA	ML-8
92FB9155AA	FORD	MF-3526
92FB9155AB	FORD	MF-3526
92FB9155BA	FORD	MF-3526
9313	CROSLAND	ML-8
93156186	GM	ML-3614
93156245	GM	ML-3387
93156246	GM	ML-3387
93156247	GM	ML-88227
93156247	GM	ML-8
93156290	GM	ML-5796
93156299	GM	ML-3614
93156300	GM	ML-3387
93156302	GM	ML-3614
93156304	GM	ML-88227
93156310	GM	ML-3387
93156351	GM	ML-3614
93156363	GM	ML-88227
93156363	GM	ML-8
93156390	GM	ML-88227
93156538	GM	ML-5566
93156540	GM	ML-5796
93156561	GM	ML-5566
93156562	GM	ML-5566



CROSS	MARCA	MILLARD
93156575	GM	ML-88227
93156575	GM	ML-8
93156634	GM	MF-4886
93156668	GM	ML-3682
93156669	GM	ML-16
93156670	GM	ML-4967
93156747	GM	ML-5552
93156769	GM	ML-3593
93156770	GM	ML-3682
93156863	GM	ML-4952
93156943	GM	MF-4886
93156952	GM	ML-88227
93156953	GM	ML-3614
93156954	GM	ML-3387
93156956	GM	ML-3593
93156958	GM	ML-3614
93161448	GM	MK-8964
93171212	GM	ML-9018
93172461	GM	MK-25270
93172463	GM	MK-25270
93175493	GM	ML-9018
93177663	GM	MK-25270
93178952	GM	ML-3387
93180258	GM	ML-9540
93181255	GM	ML-5796
93181377	GM	MF-2000
93182630	GM	ML-3593
93183040	GM	MK-7597
93183041	GM	MK-5496
93185674	GM	ML-19626
93186554	GM	ML-3614
93188944	GM	MK-9684
93188945	GM	MK-5970
93192883	GM	MK-9684
93192884	GM	MK-5970
93192885	GM	MK-5970
93193036	GM	MK-9391
93193621	GM	MF-2000
93198441	GM	ML-5796
93198598	GM	ML-5796
93428149	GM	MK-5496
93429345	GM	MF-618
93429346	GM	MF-481
9362	CROSLAND	ML-8

CROSS	MARCA	MILLARD
93891771	GM	ML-3682
93892090	GM	ML-5552
940S	GREYFRIARS	ML-8
94125784	GM	MF-4777
9414100288	GROVE	ML-8
94156052	GM	MK-5070
94177327	GM	MF-4886
94238757	GM	MF-4886
94244455	GM	MF-4886
94244456	GM	MF-4886
94248070	GM	MF-4886
94314263	GM	ML-3593
94316263	GM	ML-3593
94369299	GM	MF-4886
94376335	GM	MK-64676
94376353	GM	MK-64676
94455103	GM	ML-3593
94455838	GM	MK-43080
9450732008	BOSCH	ML-8
9451103610	BOSCH	ML-8
9456000927	FIAT	ML-5566
9456183480	FIAT	ML-5566
9456203480	FIAT	ML-5566
9456203580	FIAT	ML-5566
9457280530	BOSCH	ML-8
9457282340	BOSCH	ML-8
945928	CLARK	ML-8
946161	CLARK	ML-8
94630907	GM	ML-3387
9467521180	FIAT	ML-9814
9467558380	FIAT	ML-9814
946S	GREYFRIARS	ML-8
94840078	GM	ML-4967
94847597	GM	MF-9145
95509857	GM	ML-3387
95621989	GM	ML-3614
956550	DEMAG	ML-8
95655000	DEMAG	ML-8
9567205780	FIAT	ML-5566
95VW6714AA	FORD	MF-5030
96058042	GM	ML-3614
96068629	GM	MK-7617
96175493	GM	ML-9018
9622617880	FIAT	MF-5857

CROSS	MARCA	MILLARD
9623266380	FIAT	MF-5857
9623907180	FIAT	ML-5566
9624148680	FIAT	ML-5566
9628173380	FIAT	ML-5566
96335719	GM	MF-619
96395221	GM	ML-3387
96444649	GM	MF-618
96475855	GM	ML-92095
9647867780	FIAT	MF-5857
96536696	GM	MK-9902
965534460	GM	MK-8732
96553450	GM	MK-8732
96591485	GM	MK-91485
9662282580	FIAT	ML-9814
96628890	GM	MK-55267
96816473	GM	MF-2000
96818899	CHEVROLET	ML-5566
96827723	GM	MK-92369
96879797	GM	ML-3387
96950990	GM	MK-32823
96985730	GM	ML-92095
96FW16N619AB	FORD	MC-12021
96MF9601AA	FORD	MK-5682
96MF9601AB	FORD	MK-5682
96MM6714A1A	FORD	ML-3614
970350300	GM	MK-8067
97111423	GM	MK-8067
97251943	GM	MK-51943
97329911	GM	ML-42040
978M6714A2A	FORD	ML-3600
978M6714B2A	FORD	ML-3600
978M6714B4A	FORD	ML-3600
97AP	V T E	ML-8
97MM6714A1A	FORD	ML-3614
9808867880	FIAT	ML-10060
9830607	GUELDNER	ML-8
9830607	LINDE	ML-8
9830624	LINDE	ML-8
983067	BAUTZ	ML-8
9831079	FIAT	ML-88227
9831079	FIAT	ML-8
98432651	FIAT	ML-4847
986452001	BOSCH	ML-8
986452005	BOSCH	ML-8

CROSS	MARCA	MILLARD
98AX9601AA	FORD	MK-5929
98FU9155AA	FORD	MF-3521
990937	CHRYSLER	ML-88227
990937	CHRYSLER	ML-8
990937	CLARK	ML-8
990937	TALBOT	ML-8
9914251183400	DAIHATSU	ML-8
993021	MASSEY FERGUSON	ML-8
993029	MASSEY FERGUSON	ML-8
9957615	FIAT	MK-253
9974793	GM	MK-3660
9975120	GM	ML-16
9975138	GM	ML-3387
9975153	GM	ML-88227
9975161	GM	ML-16
9975184	GM	ML-5566
9975227	GM	ML-3614
9975233	GM	ML-5552
9975267	GM	ML-88227
9975267	GM	ML-8
9975449	GM	ML-4952
998439R91	GM	ML-88227
998439R91	GM	ML-8
9S516731AA	FORD	ML-3593
9S519176AA	FORD	MF-2000
9Y4449	CATERPILLAR	ML-8
9Y4458	CATERPILLAR	ML-8
9Y4479	CATERPILLAR	ML-8
A0001802209	MITSUBISHI	ML-9090
A1	PARTMO	ML-8
A1121840025	MITSUBISHI	ML-9090
A1121840325	MITSUBISHI	ML-9090
A146696	CASE	ML-8
A146696P	CASE	ML-8
A1SP	PARTMO	ML-8
A24372	CHRYSLER	MK-3901
A33487	CASE	ML-8
A37189	CASE	ML-8
A520843GOA	NISSAN	ML-88227
A5208H8903	NISSAN	ML-3682
A5208H8904	NISSAN	ML-3682
A5208H890C	NISSAN	ML-3682
A5208W1103	NISSAN	ML-16
A5208W1106	NISSAN	ML-16

CROSS	MARCA	MILLARD
A5208W3401	NISSAN	ML-88227
A5208W3403	NISSAN	ML-88227
A58758	CASE	ML-8
A640C59EMOSA	NISSAN	MF-5138
A640C59EMOSA	NISSAN	MF-5138
A640M41BMOSA	NISSAN	MF-4777
A640M41B-MOSA	NISSAN	MF-4777
A700X6714AA	FORD	ML-3614
A700X6714EA	FORD	ML-16
A700X6714GA	FORD	ML-16
A700X6714SA	FORD	ML-88227
A700X6714SA	FORD	ML-8
A710X6714CA	FOMOCO	ML-8
A710X6714DA	FORD	ML-16
A710X6714EA	FORD	ML-16
A720X6714ABA	FORD	ML-3387
A720X6714CA	FORD	ML-88227
A730X6714JA	FORD	ML-88227
A740X6714AA	FORD	ML-88227
A740X6714FA	FORD	ML-16
A760X6714JA	FORD	ML-3387
A760X6714KA	FORD	ML-3614
A770X6714MA	FORD	ML-16
A770X6714RA	FORD	ML-16
A770X6714UA	FORD	ML-16
A780X9155AA	FORD	MF-6400
A800X9601AA	FORD	MK-3660
A810X9601JA	FORD	MK-3660
A830X9601BRA	FORD	MK-253
A830X9601NA	FORD	MK-253
A92FX9601CA	FORD	MC-12021
AA5Z6714A	FORD	ML-10060
ABH2850	ALLOY	ML-8
ABU8542	MULTIPART	ML-8
ADT32101	BLUE PRINT	ML-8
AE28914	JOHN DEERE	ML-8
AFL1	MOTORCRAFT	ML-8
AJ0414302	MAZDA	ML-2
AJ0414302B	MAZDA	ML-2
AL1	AL-FILTERS	ML-8
AL1JA	AL-FILTERS	ML-8
AL2815	INSTALLER EDGE	ML-8
AL2951	INSTALLER EDGE	ML-8
AL483	AL-FILTERS	ML-8

CROSS	MARCA	MILLARD
AMO42095	POWERPART	ML-8
AMO42905	POWERPART	ML-8
AM1514302	MAZDA	ML-5796
AMN2007	LEYLAND	ML-8
AMO42905	PERKINS	ML-8
AOFI	ATLANTIC RICHFIELD	ML-8
API021	AP FILTERS	ML-8
API161	AP FILTERS	ML-8
AP3151A	AP FILTERS	ML-8
AP3192A	AP FILTERS	ML-8
AP3194A	AP FILTERS	ML-8
AP3252A	AP FILTERS	ML-8
AP3569	AP FILTERS	ML-8
AP3655	AP FILTERS	ML-8
AP84302A	AP FILTERS	ML-8
AS0113Z40	MAZDA	MK-5682
AS0113Z409A	MAZDA	MK-5682
AS516731AA	FORD	ML-3593
AW1	KNECHT	ML-8
AW144	KNECHT	ML-8
AW35	KNECHT	ML-8
AW56	KNECHT	ML-8
AW78	KNECHT	ML-8
AY100MT023	NISSAN	ML-3593
AY100MT024	NISSAN	ML-6355
AY100NS007	NISSAN	ML-88227
AY100NS007	NISSAN	ML-8
AY100TY014	NISSAN	ML-88227
AY100TY014	NISSAN	ML-8
AY100TY015	NISSAN	ML-20004
AY100TY017	NISSAN	ML-5552
AY100TY018	NISSAN	ML-88227
AY100TY018	NISSAN	ML-8
AY110NS001	NISSAN	ML-9432
AY110NS002	NISSAN	ML-9540
AY120NS001	NISSAN	MK-43080
AY120NS022	NISSAN	MK-6900
AZL028	COOPERS	ML-8
AZL030	COOPERS	ML-8
AZL109	COOPERS	ML-8
B1	BALDWIN	ML-8
B1	TECNOCAR	ML-8
B114	BALDWIN	ML-8
B2	BALDWIN	ML-8

CROSS	MARCA	MILLARD
B253	BALDWIN	ML-8
B297	BALDWIN	ML-8
B35914302	MAZDA	ML-6607
B59513240	MAZDA	MK-5595
B595132409A	MAZDA	MK-5595
B63014302	MAZDA	ML-6607
B63114302	KIA	ML-6607
B63114302	MAZDA	ML-6607
B65114302	MAZDA	ML-6607
B6Y014300	MAZDA	ML-6607
B6Y114302	MAZDA	ML-6607
B6Y1143029A	MAZDA	ML-6607
B6Y114302A	MAZDA	ML-6607
B6Y114302A9A	MAZDA	ML-6607
B6Y114302	MAZDA	ML-6607
B7156	BALDWIN	ML-8
B7A6714A	FORD	ML-88227
B7A6714A	FORD	ML-8
B7A6731A	FORD	ML-88227
B7A6731A	FORD	ML-8
B7A6731AB	FORD	ML-88227
B7A6731AB	FORD	ML-8
B7A6731B	FORD	ML-88227
B7A6731B	FORD	ML-8
B8A6731A	FORD	ML-88227
B8A6731A	FORD	ML-8
B9AE6714A2	FORD	ML-88227
B9AE6714A2	FORD	ML-8
B9AE6714A6	FORD	ML-88227
B9AE6714A6	FORD	ML-8
B9AE6714B	FORD	ML-88227
B9AE6714B	FORD	ML-8
B9LE6714A	FORD	ML-88227
B9LE6714A	FORD	ML-8
BA6591	FRAM	MK-6591
BA7756	FRAM	MK-7756
BATI5561A	VW GROUP	ML-5552
BBU2994	LEYLAND	ML-8
BBU2994	MULTIPART	ML-8
BC1001	P.B.R.	ML-8
BC1031	P.B.R.	ML-8
BC1037	P.B.R.	ML-8
BC1038	P.B.R.	ML-8
BC1087	P.B.R.	ML-8

CROSS	MARCA	MILLARD
BC1160	P.B.R.	ML-8
BC1166	P.B.R.	ML-8
BC1170	P.B.R.	ML-8
BC1189	P.B.R.	ML-8
BC1336	P.B.R.	ML-8
BCNN6714B	FORD	ML-88227
BCNN6714B	P.B.R.	ML-8
BFF6535	LEYLAND	ML-8
BK2Q6714AA	FORD	ML-10060
BK2Q6714BA	FORD	ML-10060
BLS1A	WB	ML-8
BT111	BALDWIN	ML-8
BT216	BALDWIN	ML-8
BT251	BALDWIN	ML-8
BT266	BALDWIN	ML-8
BT267	BALDWIN	ML-8
BT524	BALDWIN	ML-8
C012000013	TOYOTA	ML-88227
C012000013	TOYOTA	ML-8
C025	VIC	ML-8
COAE6714B	FORD	ML-88227
COAE6714B	FORD	ML-8
C10026	FRAM	MF-2000
C10026A	FRAM	MF-2000
C101	VIC	ML-8
C105	CHAMPION	ML-8
C105	VIC	ML-8
C110	UNION JAPAN	ML-8
C1121	SAKURA	ML-8
C150	CHAMPION	ML-8
C150	UNION JAPAN	ML-8
C153	CHAMPION	ML-8
C1803	SAKURA	ML-8
C1AZ6731	FORD	ML-88227
C1AZ6731	FORD	ML-8
C1AZ6731A	FORD	ML-88227
C1AZ6731A	FORD	ML-8
C1AZ6731AP	FORD	ML-88227
C1AZ6731AP	FORD	ML-8
C205	VIC	ML-8
C301302	FRAM	MK-5970
C3AE6714A	FORD	ML-88227
C3AE6714A	FORD	ML-8
C3AE6714B	FORD	ML-88227

CROSS	MARCA	MILLARD
C3AE6714B	FORD	ML-8
C47481P4	MANITOU	ML-8
C4AE6714A	FORD	ML-88227
C4AE6714A	FORD	ML-8
C4AZ6731A	FORD	ML-88227
C4AZ6731A	FORD	ML-8
C60113Z40	MAZDA	MK-15920
C60114302	MAZDA	ML-3600
C6TZ9600A	FORD	MK-253
C77NN6714B	FORD	ML-88227
C7NN6714B	FORD	ML-88227
C7NN6714B	FORD	ML-8
C8AF9614A	FORD	ML-88227
C8AF9614A	FORD	ML-8
C9766	FRAM	MF-52021
C9766ECO	FRAM	MF-52021
CA10057	FRAM	MK-69754
CA10070	FRAM	MK-5970
CA10086	FRAM	MK-8000
CA10088	FRAM	MK-26123
CA10092	FRAM	MK-19158
CA10097	FRAM	MK-25270
CA10112	FRAM	MK-0C010
CA10118	FRAM	MK-10118
CA10144	FRAM	MK-9391
CA10165	FRAM	MK-80146
CA10173	FRAM	MK-1780
CA10190	FRAM	MK-21050
CA10192	FRAM	MK-7764
CA10228	FRAM	MK-16246
CA10234	FRAM	MK-35681
CA10242	FRAM	MK-52045
CA10249	FRAM	MK-8964
CA10262	FRAM	MK-95334
CA10290	FRAM	MK-73667
CA10327	FRAM	MK-20040
CA10330	FRAM	MK-93235
CA10409	FRAM	MK-9431
CA10447	FRAM	MK-9074
CA10466	FRAM	MK-76855
CA10519	FRAM	MK-8732
CA10525	FRAM	MK-41437
CA10622	FRAM	MK-10118
CA10630	FRAM	MK-38183

CROSS	MARCA	MILLARD
CA10653	FRAM	MK-26934
CA107	WIPAC	ML-8
CA10767	FRAM	MK-91485
CA10880	FRAM	MK-14641
CA11071	FRAM	MK-92369
CA11097	FRAM	MK-5827
CA11222	FRAM	MK-32823
CA11655	FRAM	MK-8970
CA11711	FRAM	MK-43080
CA120	WIPAC	ML-8
CA124	FRAM	ML-88227
CA124	FRAM	ML-8
CA2719B	FRAM	MK-4939
CA3441	FRAM	MK-3660
CA3660	FRAM	MK-3660
CA3901	FRAM	MK-3901
CA3916	FRAM	MK-3916
CA3997	FRAM	MK-8970
CA4309	FRAM	MK-43080
CA4563	FRAM	MK-5595
CA4567	FRAM	MK-9015
CA4576	FRAM	MK-5929
CA4924	FRAM	MK-6900
CA4939	FRAM	MK-4939
CA5056	FRAM	MK-5056
CA5070	FRAM	MK-5070
CA5107	FRAM	MK-5107
CA5108	FRAM	MK-5107
CA5205	FRAM	MK-3916
CA5267	FRAM	MK-7421
CA5290	FRAM	MK-6362
CA530	FRAM	MK-5301
CA5301	FRAM	MK-5301
CA5345	FRAM	MK-52391
CA5357	FRAM	MK-5357
CA5370	FRAM	MK-7431
CA5377	FRAM	MK-5377
CA5378	FRAM	MK-5377
CA5384	FRAM	MK-3660
CA5397	FRAM	MK-9015
CA5431	FRAM	MK-6807
CA5436	FRAM	MK-5827
CA5466	FRAM	MK-5466
CA5468	FRAM	MK-5468

CROSS	MARCA	MILLARD
CA5496	FRAM	MK-5496
CA5506	FRAM	MK-7142
CA5595	FRAM	MK-5595
CA5619	FRAM	MK-6900
CA5663	FRAM	MC-5663
CA5682	FRAM	MK-5682
CA5739	FRAM	MK-3901
CA5751	FRAM	MK-3901
CA5780	FRAM	MK-3901
CA5825	FRAM	MK-43080
CA5827	FRAM	MK-5827
CA5891	FRAM	MK-59160
CA5904	FRAM	MK-5377
CA5929	FRAM	MK-5929
CA5970	FRAM	MK-5970
CA6362	FRAM	MK-6362
CA6479	FRAM	MK-6479
CA6541	FRAM	MK-5682
CA6544	FRAM	MK-6544
CA6545	FRAM	MK-5301
CA6546	FRAM	MK-4939
CA6690	FRAM	MK-64676
CA6807	FRAM	MK-6807
CA6850	FRAM	MK-6850
CA6900	FRAM	MK-6900
CA7142	FRAM	MK-7142
CA7344	FRAM	MK-7344
CA7351	FRAM	MK-7351
CA7417	FRAM	MK-8067
CA7420	FRAM	MK-7420
CA7421	FRAM	MK-7421
CA7431	FRAM	MK-7431
CA7440	FRAM	MK-7440
CA7597	FRAM	MK-7597
CA7617	FRAM	MK-7617
CA7756	FRAM	MK-7756
CA7764	FRAM	MK-7764
CA8004	FRAM	MK-8004
CA8010	FRAM	MK-5466
CA8014	FRAM	MK-5827
CA8038	FRAM	MK-8038
CA8039	FRAM	MK-8004
CA8040	FRAM	MK-6900
CA8041	FRAM	MK-6900

CROSS	MARCA	MILLARD
CA8067	FRAM	MK-8067
CA8069	FRAM	MK-8069
CA8080	FRAM	MK-5107
CA8141	FRAM	MK-8141
CA8208	FRAM	MK-8208
CA8243	FRAM	MK-8243
CA8548	FRAM	MK-8548
CA8602	FRAM	MK-5827
CA8715	FRAM	MK-5827
CA8736	FRAM	MK-9896
CA8772	FRAM	MK-253
CA8805	FRAM	MK-8805
CA8817	FRAM	MK-18777
CA8829	FRAM	MK-3901
CA8858	FRAM	MK-7440
CA8886	FRAM	MK-9015
CA8887	FRAM	MK-5107
CA8888	FRAM	MK-3901
CA8911	FRAM	MK-8911
CA8964	FRAM	MK-8964
CA8969	FRAM	MK-5929
CA8970	FRAM	MK-8970
CA8995	FRAM	MK-8995
CA8997	FRAM	MK-8997
CA9015	FRAM	MK-9015
CA9074	FRAM	MK-9074
CA9079	FRAM	MK-8067
CA9082	FRAM	MK-8970
CA9115	FRAM	MK-9115
CA9126	FRAM	MK-82139
CA9269	FRAM	MK-40048
CA9295	FRAM	MK-9115
CA9332	FRAM	MK-9332
CA9341	FRAM	MK-9431
CA9345	FRAM	MK-9345
CA9360	FRAM	MK-20040
CA9391	FRAM	MK-9391
CA9392	FRAM	MK-9392
CA9401	FRAM	MK-9401
CA9409	FRAM	MK-25045
CA9424	FRAM	MK-5827
CA9431	FRAM	MK-9431
CA9435	FRAM	MK-15920
CA9482	FRAM	MK-9482

CROSS	MARCA	MILLARD
CA9494	FRAM	MK-15920
CA9519	FRAM	MK-9015
CA9632	FRAM	MK-24086
CA9652	FRAM	MK-25270
CA9653	FRAM	MK-25270
CA9683	FRAM	MK-9683
CA9684	FRAM	MK-9684
CA9687	FRAM	MK-9687
CA9694	FRAM	MK-5056
CA9711	FRAM	MK-69754
CA9757	FRAM	MK-24086
CA9759	FRAM	MK-9896
CA9800	FRAM	MK-35495
CA9895	FRAM	MK-9895
CA9898	FRAM	MK-96431
CA9902	FRAM	MK-9902
CA9916	FRAM	MK-0C010
CA9945	FRAM	MK-72373
CAK253	FRAM	MK-253
CC1IAZ6731A	FORD	ML-88227
CC1IAZ6731A	FORD	ML-8
CC1A2671A	FORD	ML-88227
CC1A2671A	FORD	ML-8
CC1AZ6731A	FORD	ML-88227
CC1AZ6731A	FORD	ML-8
CD120002	MITSUBISHI	ML-6355
CD8	CARDOC	ML-8
CF5474	FRAM	MC-5663
CF5663	FRAM	MC-5663
CF5817	FRAM	MC-12021
CF8644	FRAM	MC-5663
CF8831	FRAM	MC-67836C
CF8893	FRAM	MC-5663
CF9118A	FRAM	MC-67836C
CF9323	FRAM	MC-9323C
CF9666	FRAM	MC-16462
CF9819	FRAM	MC-35422
CF98192	FRAM	MC-35422
CFA8831	FRAM	MC-67836C
CFA9404	FRAM	MC-9323C
CFI1H08	INTERFIL	MC-5663
CFI1H08CA	INTERFIL	MC-5663
CFI2S5A	INTERFIL	MC-35422
CFI2S5ACA	INTERFIL	MC-35422

CROSS	MARCA	MILLARD
CFI2S6H	INTERFIL	MC-16462
CFI2S6HCA	INTERFIL	MC-16462
CFI6Q08	INTERFIL	MC-9323C
CFI6Q08CA	INTERFIL	MC-9323C
CFI96FW	INTERFIL	MC-12021
CFI96FWCA	INTERFIL	MC-12021
CFIXS4H	INTERFIL	MC-67836C
CFIXS4HCA	INTERFIL	MC-67836C
CH0008	CHAMPION-VENEZUELA	ML-8
CH10066	FRAM	ML-9814
CH10066ECO	FRAM	ML-9814
CH10246	FRAM	ML-19626
CH10246ECO	FRAM	ML-19626
CH10295	FRAM	ML-12027
CH10717AECO	FRAM	ML-9814
CH10717ECO	FIAT	ML-9814
CH10717ECO	FRAM	ML-9814
CH11252ECO	FRAM	ML-96796
CH5993	FRAM	ML-9090
CH5993ECO	FRAM	ML-9090
CH8	CHAMPION-VENEZUELA	ML-8
CH8481	FRAM	ML-9090
CH8481ECO	FRAM	ML-9090
CH8607	FRAM	ML-9090
CH8902	FRAM	ML-9090
CH8902ECO	FRAM	ML-9090
CH9011	FRAM	ML-9090
CH9011ECO	FRAM	ML-9090
CH9018	FRAM	ML-9018
CH9018ECO	FRAM	ML-9018
CH9301	FRAM	ML-9090
CH9301ECO	FRAM	ML-9090
CH9382	FRAM	ML-321
CH9382ECO	FRAM	ML-321
CH9432	FRAM	ML-9432
CH9432ECO	FRAM	ML-9432
CH9461	FRAM	ML-9463
CH9461ECO	FRAM	ML-9463
CH9463	FRAM	ML-9463
CH9463AECO	FRAM	ML-9463
CH9463ECO	FRAM	ML-9463
CH9496	FRAM	ML-14120
CH9496ECO	FRAM	ML-14120
CH9540	FRAM	ML-9540

CROSS	MARCA	MILLARD
CH9540ECO	FRAM	ML-9540
CH9641	FRAM	ML-321
CH9706	FRAM	ML-52149
CH9706ECO	FRAM	ML-52149
CH9814	FRAM	ML-9814
CH9814ECO	FRAM	ML-9814
CH9911	FRAM	ML-14120
CH9911ECO	FRAM	ML-14120
CH9954	FRAM	ML-14120
CH9972	FRAM	ML-44155
CH9973	FRAM	ML-9814
CH9973AECO	FRAM	ML-9814
CH9973ECO	FRAM	ML-9814
CH99743AECO	FRAM	ML-9814
CIAZ6731A	FOMOCO	ML-8
CIAZ6731AP	FOMOCO	ML-8
CLH419	GIESSE	ML-8
CLH455	GIESSE	ML-8
COAE6714A	FORD	ML-88227
COAE6714A	FORD	ML-8
COAE6731A	FORD	ML-88227
COAE6731A	FORD	ML-8
COAE6731AP	FORD	ML-88227
COAE6731AP	FORD	ML-8
COLE6714A	FORD	ML-88227
COLE6714A	FORD	ML-8
CV320	SOPARIS	ML-8
CV368	SOPARIS	ML-8
CV401	SOPARIS	ML-8
CV405	SOPARIS	ML-8
CV472	SOPARIS	ML-8
CV507	SOPARIS	ML-8
CY0113Z40A	MAZDA	MK-52045
DONN6714B	FORD	ML-88227
DONN6714B	FORD	ML-8
D1NN6714C	FORD	ML-88227
D1NN6714C	FORD	ML-8
D22	KRALINATOR	ML-8
D29869	CASE	ML-8
D29891	CASE	ML-8
D29896	CASE	ML-8
D2NN6714A	FOMOCO	ML-8
D2NN6714C	FORD	ML-88227
D2NN6714C	FOMOCO	ML-8

CROSS	MARCA	MILLARD
D2NN6714C	FORD	ML-8
D3HZ6731B	FOMOCO	ML-8
D5NN6714A	FORD	ML-16
D8NN6714GA	FORD	ML-88227
D8NN6714GA	FORD	ML-8
D8NN6714LA	FORD	ML-88227
D8PJ6714AA	FORD	ML-88227
D8PJ6714AA	FORD	ML-8
D92068246	GM	ML-3675
D9AE6714AA	FORD	ML-88227
D9AE6714AA	FORD	ML-8
D9AZ6731A	FORD	ML-88227
D9AZ6731A	FORD	ML-8
D9NN6714AA	FOMOCO	ML-8
D9NN6714EA	FORD	ML-88227
D9NN6714EA	FORD	ML-8
DA111	DORMAN	ML-8
DFFO53011	MITSUBISHI	MF-3541
DGM0940	DIGOEMA FILTER	ML-8
DGMO1010	DIGOEMA FILTER	ML-8
DGMO940	DIGOEMA FILTER	ML-8
DL1A	DARUMA	ML-8
DO1819	CLEAN	ML-8
DO225	CLEAN	ML-8
DO225B	P.B.R.	ML-8
DO225C	CLEAN	ML-8
DO225D	CLEAN	ML-8
DO298	CLEAN	ML-8
DO896	CLEAN	ML-8
DONN6714A	FOMOCO	ML-8
DONN6714B	FORD	ML-88227
DONN6714B	FORD	ML-8
E1FZ6731A	FORD	ML-3600
E1FZ6731A	FORD	ML-5552
E1ZE6714AA	FORD	ML-88227
E1ZE6714AA	FORD	ML-8
E35E9155CZA	FORD	MF-800
E3EE9155C	FORD	MF-800
E3EE9155C2C	FORD	MF-800
E3EE9155CB	FORD	MF-800
E3EE9155CC	FORD	MF-800
E3FZ9155C	FORD	MF-800
E3SE9155CB	FORD	MF-800
E4FZ6731AB	FORD	ML-3600

CROSS	MARCA	MILLARD
E4FZ9601A	FORD	MK-3660
E5120700509	VW GROUP	ML-5552
E55E9155AA	FORD	MF-800
E5778M	TALBOT	ML-8
E5HN6714AA	FORD	ML-88227
E5HN6714AA	FORD	ML-8
E5SE9155A	FORD	MF-800
E5TE9601AB	FORD	MK-5056
E5TE9601ABM	FORD	MK-5056
E5TZ9601B	FORD	MK-5056
E5TZ9D695A	FORD	MK-6591
E70Z9155A	FORD	MF-800
E7DE9155AA	FORD	MF-800
E7DZ9155A	FORD	MF-800
E7RY9155A	FORD	MF-3744
E7TE9D695BA	FORD	MK-6591
E7TZ9D695A	FORD	MK-6591
E83C9B072AA	FORD	MF-800
E8NN6714BA	FORD	ML-88227
E99A9B072AA	FORD	MF-800
E99Z9B072	FORD	MF-800
E99Z9B072A	FORD	MF-800
E9AE6714B	FORD	ML-88227
E9AE6714B	FORD	ML-8
E9GZ6731A	FORD	ML-6607
E9TA9B072CA	FORD	MF-800
E9TZ9B072CA	FORD	MF-800
ECC6714A	FORD	ML-88227
ECC6714A	FORD	ML-8
ECOF1515	ECOFIL	ML-8
ECZ6714C	FORD	ML-88227
ECZ6714C	FORD	ML-8
EDC6714A	FORD	ML-88227
EDC6714A	FORD	ML-8
EDG6714A	FORD	ML-88227
EDG6714A	FORD	ML-8
EDG6714C	FORD	ML-88227
EDG6714C	FORD	ML-8
EDL966	LUCAS (LUCAS-TRW)	ML-8
EFL001	MOTORCRAFT	ML-8
EFL060	MOTORCRAFT	ML-8
EFL1	MOTORCRAFT	ML-8
EFL133	MOTORCRAFT	ML-8
EFL230	MOTORCRAFT	ML-8

CROSS	MARCA	MILLARD
EFL291	MOTORCRAFT	ML-8
EFL316	MOTORCRAFT	ML-8
EFL60	MOTORCRAFT	ML-8
EFL74	MOTORCRAFT	ML-8
EFL77	MOTORCRAFT	ML-8
EFL905	MOTORCRAFT	ML-8
EFL92	MOTORCRAFT	ML-8
EH16	TAMIX	ML-8
EK1513	ELOFIC	ML-8
ELH4037	MECAFILTER	ML-8
ELH4126	MECAFILTER	ML-8
ELH4141	MECAFILTER	ML-8
ELH4141	PERMATIC	ML-8
ELH4267	MECAFILTER	ML-8
ELH4269	MECAFILTER	ML-8
ELH4277	MECAFILTER	ML-8
ELH4280	MECAFILTER	ML-8
ELH4321	MECAFILTER	ML-8
ELHA4037	MECAFILTER	ML-8
EOF030	COMLINE	ML-8
EOF047	COMLINE	ML-8
ERC1444	LEYLAND	ML-8
ERR1168	ROVER	ML-8
ERR3340	ROVER	ML-8
FO02H234378F8	BOSCH	ML-8
F02Z9155A	FORD	MF-800
F02Z9601A1A	FORD	MK-5682
F0T29155B	FORD	MF-3521
F0TE9155AA	FORD	MF-3521
F0TZ9155B	FORD	MF-3521
F100A88	INTERFIL	MK-26123
F101A15	INTERFIL	MK-55267
F101A73	INTERFIL	MK-1780
F101A90	INTERFIL	MK-21050
F102A42	INTERFIL	MK-52045
F103A28	INTERFIL	MK-69754
F103A30	INTERFIL	MK-93235
F104A66	INTERFIL	MK-76855
F104A97	INTERFIL	MK-41437
F106A50	INTERFIL	MK-94973
F10A01	INTERFIL	MK-95021
F10A45	INTERFIL	MK-8805
F11A69	INTERFIL	MK-83293
F13A27	INTERFIL	MK-25175

CROSS	MARCA	MILLARD
F14A85	INTERFIL	MK-91485
F15A00	INTERFIL	MK-51943
F16A88	INTERFIL	MK-5929
F16A91	INTERFIL	MK-7764
F16A94	INTERFIL	MK-10118
F17A22	INTERFIL	MK-80146
F17A80	INTERFIL	MK-0C010
F17AH0	INTERFIL	MK-20040
F18A83	INTERFIL	MK-95334
F19A04	INTERFIL	MK-26934
F19A35	INTERFIL	MK-5970
FIAE6714BC	FORD	ML-2
F1KA01	INTERFIL	MK-69754
F20113Z00	FORD	MK-5682
F20113Z40	MAZDA	MK-5682
F20113Z409A	MAZDA	MK-5682
F20A10	INTERFIL	MK-72373
F20A82	INTERFIL	MK-5929
F21A03	INTERFIL	MK-9115
F238202310010	FENDT	ML-8
F24A04	INTERFIL	MK-9401
F24A61	INTERFIL	MK-25270
F24A96	INTERFIL	MK-5056
F26A75	INTERFIL	MK-9482
F27A50	INTERFIL	MK-29058
F28A00	INTERFIL	MK-68338
F28A13	INTERFIL	MK-25252
F2KA53	INTERFIL	MK-253
F2KA62	INTERFIL	MK-35495
F2TA9A335BB	FORD	MF-3521
F2Y014302A	MAZDA	ML-3593
F31A28	INTERFIL	MK-38183
F33A00	INTERFIL	MK-4939
F34A41	INTERFIL	MK-3660
F34A50	INTERFIL	MK-8732
F353A	INTERFIL	MK-6900
F36A12	INTERFIL	MK-9015
F36A60	INTERFIL	MK-3660
F381A	INTERFIL	MK-9074
F39A01	INTERFIL	MK-3901
F39A16	INTERFIL	MK-3916
F3XY9155A	FORD	MF-7404
F41A00	INTERFIL	MK-6900
F41A16	INTERFIL	MK-5377

CROSS	MARCA	MILLARD
F43A09	INTERFIL	MK-43080
F44AQW	INTERFIL	MK-20040
F44AW2	INTERFIL	MK-8970
F45A76	INTERFIL	MK-5929
F49A39	INTERFIL	MK-4939
F4UA9A335CE	FORD	MF-3521
F503	FIBA	ML-8
F50A58	INTERFIL	MK-5468
F50X9601A	FORD	MK-8004
F50X9601AB	FORD	MK-8004
F50Y9601A	FORD	MK-8004
F50Y9601AB	FORD	MK-8004
F50Z9601BA	FORD	MK-8004
F54A66	INTERFIL	MK-5466
F54A96	INTERFIL	MK-5496
F55A95	INTERFIL	MK-5595
F56A26	INTERFIL	MK-9391
F56A82	INTERFIL	MK-5682
F57A24	INTERFIL	MK-8964
F580A	INTERFIL	MK-5682
F583A	INTERFIL	MK-82139
F50X9601AB	FORD	MK-8004
F600L3750	CONTINENTAL ENG.	ML-8
F60A00	INTERFIL	MK-35681
F63A62	INTERFIL	MK-6362
F64A79	INTERFIL	MK-6479
F65A44	INTERFIL	MK-6544
F65A45	INTERFIL	MK-5301
F65A60	INTERFIL	MK-4939
F65A76	INTERFIL	MK-7142
F66A00	INTERFIL	MK-5468
F66A19	INTERFIL	MK-6900
F66A19A	INTERFIL	MK-6900
F66A90	INTERFIL	MK-64676
F67Z9601AA	FORD	MK-8141
F68A07	INTERFIL	MK-6807
F68A50	INTERFIL	MK-6850
F6CA11	INTERFIL	MK-73667
F6EA53	INTERFIL	MK-19158
F6QA01	INTERFIL	MK-9431
F6ZZ9601A	FORD	MK-8004
F71A42	INTERFIL	MK-7142
F73A44	INTERFIL	MK-7344
F73A51	INTERFIL	MK-7351

CROSS	MARCA	MILLARD
F74A17	INTERFIL	MK-8067
F74A20	INTERFIL	MK-7420
F74A21	INTERFIL	MK-7431
F74A27	INTERFIL	MK-8067
F74A31	INTERFIL	MK-7431
F74A40	INTERFIL	MK-7440
F75A01	INTERFIL	MK-52391
F75A97	INTERFIL	MK-7597
F76A17	INTERFIL	MK-7617
F76A51	INTERFIL	MK-5107
F77A64	INTERFIL	MK-7764
F77Z9601AA	FORD	MK-8243
F78A40	INTERFIL	MK-15920
F7NA15	INTERFIL	MK-9431
F80223802	MAZDA	ML-3593
F802238029A	MAZDA	ML-3593
F80A10	INTERFIL	MK-5466
F80A38	INTERFIL	MK-8038
F80A69	INTERFIL	MK-8069
F80A80	INTERFIL	MK-5107
F81A41	INTERFIL	MK-8141
F81A42	INTERFIL	MK-5357
F82A08	INTERFIL	MK-8548
F82A43	INTERFIL	MK-8243
F85A00	INTERFIL	MK-40048
F86A02	INTERFIL	MK-5827
F87A15	INTERFIL	MK-5827
F87A36	INTERFIL	MK-9896
F87A54	INTERFIL	MK-6479
F87A60	INTERFIL	MK-8995
F87E6714AA	FORD	ML-88227
F88A05	INTERFIL	MK-8805
F88A17	INTERFIL	MK-18777
F89A25	INTERFIL	MK-8243
F89A70	INTERFIL	MK-8970
F89A97	INTERFIL	MK-8997
F89E9155AA	FORD	MF-986
F89Z9155A	FORD	MF-986
F8B313240	MAZDA	MK-5682
F8B313Z40	MAZDA	MK-5682
F8B313Z409A	MAZDA	MK-5682
F8CZ6731AA	FORD	ML-5552
F8XA9155AA	FORD	MF-4777
F91A13	INTERFIL	MK-3901

CROSS	MARCA	MILLARD
F92A69	INTERFIL	MK-40048
F92A88	INTERFIL	MK-3901
F93A32	INTERFIL	MK-9332
F93A45	INTERFIL	MK-9345
F93A60	INTERFIL	MK-20040
F93A92	INTERFIL	MK-9392
F94A09	INTERFIL	MK-25045
F94A82	INTERFIL	MK-9482
F94A93	INTERFIL	MK-8964
F95A63	INTERFIL	MK-8243
F95A89	INTERFIL	MK-6362
F96A20	INTERFIL	MK-8995
F96A21	INTERFIL	MK-7020
F96A23	INTERFIL	MK-92369
F96A69	INTERFIL	MK-5929
F96A83	INTERFIL	MK-9683
F96A87	INTERFIL	MK-9687
F98A95	INTERFIL	MK-9895
F98A98	INTERFIL	MK-96431
F99A02	INTERFIL	MK-9902
F99A33	INTERFIL	MK-16246
F99A48	INTERFIL	MK-5595
FA3441	INTERFIL	MK-3660
FA4309	INTERFIL	MK-43080
FA5496	INTERFIL	MK-5496
FA7597	INTERFIL	MK-7597
FB2058	TECALEMIT	ML-8
FB2062	TECALEMIT	ML-8
FB2062	TJ FILTERS	ML-8
FB2064	TECALEMIT	ML-8
FB2064	TJ FILTERS	ML-8
FB2068	TECALEMIT	ML-8
FB2068	TJ FILTERS	ML-8
FB2071	TECALEMIT	ML-8
FB2093	TECALEMIT	ML-8
FB2093	TJ FILTERS	ML-8
FB5400	TECALEMIT	ML-8
FB5400	TJ FILTERS	ML-8
FB5471	TECALEMIT	ML-8
FB5471	TJ FILTERS	ML-8
FC184	AP LOCKHEED	ML-8
FD26	DIAMOND	ML-8
FE6513480	MAZDA	MF-9145
FEY014302	MAZDA	ML-6607

CROSS	MARCA	MILLARD
FEY0143029A	MAZDA	ML-6607
FEYO14302	MAZDA	ML-3593
FEYO143029A	MAZDA	ML-3593
FF254EC	FILT	ML-8
FF309EC	FILT	ML-8
FF399EC	FILT	ML-8
FF599AR	FILT	ML-8
FFUPI0401	FINN-FILTER	ML-8
FGI0168	INTERFIL	MF-6400
FGI018	INTERFIL	MF-986
FGI062	INTERFIL	MF-5857
FGI100	INTERFIL	MF-4886
FGI101	INTERFIL	MF-4922
FGI1012	INTERFIL	MF-618
FGI1027	INTERFIL	MF-4777
FGI104	INTERFIL	MF-3744
FGI105	INTERFIL	MF-5870
FGI105A	INTERFIL	MF-5870
FGI111	INTERFIL	MF-800
FGI112	INTERFIL	MF-5237
FGI115	INTERFIL	MF-580
FGI115A	INTERFIL	MF-580
FGI112	INTERFIL	MF-618
FGI132	INTERFIL	MF-3526
FGI133	INTERFIL	MF-986
FGI136	INTERFIL	MF-5738
FGI136A	INTERFIL	MF-5738
FGI137	INTERFIL	MF-645A
FGI137A	INTERFIL	MF-645A
FGI138A	INTERFIL	MF-1582
FGI141	INTERFIL	MF-6400
FGI151	INTERFIL	MF-4132
FGI160	INTERFIL	MF-75110
FGI118	INTERFIL	MF-3521
FGI119	INTERFIL	MF-481
FGI19119	INTERFIL	MF-481
FGI194	INTERFIL	MF-5982
FGI206A	INTERFIL	MF-6397
FGI207A	INTERFIL	MF-1036
FGI214	INTERFIL	MF-283
FGI220	INTERFIL	MF-7196
FGI222	INTERFIL	MF-90122
FGI227	INTERFIL	MF-619
FGI235	INTERFIL	MF-74058

CROSS	MARCA	MILLARD
FGI242	INTERFIL	MF-25248
FGI245	INTERFIL	MF-1051
FGI26	INTERFIL	MF-578
FGI261	INTERFIL	MF-5982
FGI26A	INTERFIL	MF-578
FGI27	INTERFIL	MF-4777
FGI276	INTERFIL	MF-74120
FGI278D	INTERFIL	MF-73138
FGI27A	INTERFIL	MF-4777
FGI28	INTERFIL	MF-5030
FGI280	INTERFIL	MF-2000
FGI28A	INTERFIL	MF-5030
FGI298	INTERFIL	MF-74120
FGI300D	INTERFIL	MF-52021
FGI325	INTERFIL	MF-74120
FGI37	INTERFIL	MF-5237
FGI37A	INTERFIL	MF-5237
FGI40	INTERFIL	MF-3541
FGI45	INTERFIL	MF-6826
FGI47	INTERFIL	MF-7404
FGI49	INTERFIL	MF-3541
FGI50	INTERFIL	MF-6680
FGI52	INTERFIL	MF-7599
FGI53A	INTERFIL	MF-1680
FGI84	INTERFIL	MF-9145
FGI86	INTERFIL	MF-3747
FGI90	INTERFIL	MF-7196
FGI95	INTERFIL	MF-3744
FL1	MOTORCRAFT	ML-8
FL101	FIBA	ML-8
FL1A	MOTORCRAFT	ML-8
FL209	FIBA	ML-8
FL30001	FILTECH	ML-8
FLR254	WORTHINGTON	ML-8
FO201S	JAPAN PARTS	ML-8
FO206S	JAPAN PARTS	ML-8
FO266	MÜLLER FILTER	ML-8
FO371	KNECHT	ML-8
FO37112	KNECHT	ML-8
FO3715	KNECHT	ML-8
FO6702	TANCLICK	ML-8
FOE025	FISPA	ML-8
FOE060	AUTOPART	ML-8
FOE275	FISPA	ML-8



CROSS	MARCA	MILLARD
FOT29155B	FORD	MF-3521
FOTE9155AA	FORD	MF-3521
FOTZ9155B	FORD	MF-3521
FPL1A	FILPOWER	ML-8
FS5620490A	MAZDA	MF-7404
FT4403	COOPERSFIAAM	ML-8
FT4677	COOPERSFIAAM	ML-8
FT4702	COOPERSFIAAM	ML-8
FT4765	COOPERSFIAAM	ML-8
FT4790	COOPERSFIAAM	ML-8
FT4790A	COOPERSFIAAM	ML-8
FT4863	COOPERSFIAAM	ML-8
FT4905	COOPERSFIAAM	ML-8
FT5363	COOPERSFIAAM	ML-8
FT5567	COOPERSFIAAM	ML-8
FX0001	DELPHI	ML-8
FX0017	DELPHI	ML-8
FX0021	DELPHI	ML-8
FX0024	DELPHI	ML-8
FX0038	DELPHI	ML-8
FX0070	DELPHI	ML-8
FX0131	DELPHI	ML-8
FX20002	DELPHI	ML-8
FX20017	AC DELCO	ML-8
FX20017	DELPHI	ML-8
G10146	FRAM	MF-74120
G10147	FRAM	MF-74120
G10166	FRAM	MF-1083
G10230	FRAM	MF-5857
G11140	FRAM	MF-90122
G180522	FORD	MK-5357
G1829195	MANITOU	ML-8
G313	GONHER	ML-14120
G3727	FRAM	MF-481
G3727DP	FRAM	MF-481
G3744	FRAM	MF-3744
G3745	FRAM	MF-3744
G3746	FRAM	MF-3744
G3747	FRAM	MF-3747
G3802	FRAM	MF-800
G3802A	FRAM	MF-800
G3829	FRAM	MF-5030
G3850	FRAM	MF-3521
G4194	FRAM	MF-7404

CROSS	MARCA	MILLARD
G434	GONHER	MF-52021
G45210	CASE	ML-8
G45306	CASE	ML-8
G466	GONHER	ML-9463
G4777	FRAM	MF-4777
G5237	FRAM	MF-5237
G54306	CASE	ML-8
G5540	FRAM	MF-618
G562	GONHER	ML-52149
G5659	FRAM	MF-6826
G5738	FRAM	MF-5738
G5773	FRAM	MF-5030
G5857	FRAM	MF-5857
G5870	FRAM	MF-5870
G5968	FRAM	MF-3541
G5978	FRAM	MF-618
G5982	FRAM	MF-5982
G5995	FRAM	MF-618
G6398	FRAM	MF-3744
G6400	FRAM	MF-6400
G6462	FRAM	MF-3541
G6465	FRAM	MF-3541
G6553	FRAM	MF-3541
G6674	FRAM	MF-9145
G6680	FRAM	MF-6680
G6825	FRAM	MF-6680
G6826	FRAM	MF-6826
G6Y014302A	MAZDA	ML-3593
G7099	FRAM	MF-3526
G7143	FRAM	MF-618
G7194	FRAM	MF-3541
G7196	FRAM	MF-7196
G7315	FRAM	MF-578
G7333	FRAM	MF-580
G7393	FRAM	MF-6400
G7404	FRAM	MF-7404
G7416	FRAM	MF-618
G7599	FRAM	MF-7599
G7612	FRAM	MF-9145
G7647	FRAM	MF-3541
G77281	CONTINENTAL ENG.	ML-8
G7767	FRAM	MF-3541
G7770	FRAM	MF-3541
G8018	FRAM	MF-986

CROSS	MARCA	MILLARD
G8075	FRAM	MF-4132
G8160	FRAM	MF-9000
G8164	FRAM	MF-3541
G8219	FRAM	MF-645A
G8897	FRAM	MF-74058
G9343	FRAM	MF-1036
G9344	FRAM	MF-6397
G9716	FRAM	MF-6400
G9791	FRAM	MF-1051
GA130	GONHER	MK-5357
GA134	GONHER	MK-5496
GA158	GONHER	MK-8243
GA16	GONHER	MK-253
GA163	GONHER	MK-6807
GA164	GONHER	MK-5070
GA165	GONHER	MK-7421
GA176	GONHER	MK-6591
GA2124	GONHER	MK-25045
GA271	GONHER	MK-3660
GA279	GONHER	MK-7597
GA286	GONHER	MK-6544
GA300	GONHER	MK-7440
GA348	GONHER	MK-5070
GA354	GONHER	MK-5682
GA3901	GONHER	MK-3901
GA413R	GONHER	MK-40048
GAD116	GONHER	MK-35681
GAD117	GONHER	MK-6900
GAD15	GONHER	MK-43080
GAK16	GONHER	MK-253
GAVW120	GONHER	MK-5301
GAVW121	GONHER	MK-7431
GAVW619	GONHER	MK-69754
GAVW620	GONHER	MK-5377
GAVW621	GONHER	MK-5827
GAVW629	GONHER	MK-35495
GF633	GM	MF-618
GFE1068	UNIPART	ML-8
GFE116	UNIPART	ML-8
GFE151	UNIPART	ML-8
GFE168	UNIPART	ML-8
GFE175	UNIPART	ML-8
GFE181	UNIPART	ML-8
GFE187	UNIPART	ML-8

CROSS	MARCA	MILLARD
GFE248	UNIPART	ML-8
GFE300	UNIPART	ML-8
GG102	GONHER	MF-5870
GG107	GONHER	MF-74120
GG137	GONHER	MF-5237
GG160	GONHER	MF-7599
GG161	GONHER	MF-6826
GG164	GONHER	MF-4132
GG184	GONHER	MF-6826
GG187	GONHER	MF-6680
GG1872	GONHER	MF-3521
GG195	GONHER	MF-1582
GG213	GONHER	MF-9145
GG246	GONHER	MF-3747
GG251	GONHER	MF-5030
GG252	GONHER	MF-5738
GG291	GONHER	MF-5857
GG312	GONHER	MF-5857
GG46	GONHER	MF-481
GG47	GONHER	MF-800
GG63	GONHER	MF-4777
GG64	GONHER	MF-618
GG66	GONHER	MF-578
GG82	GONHER	MF-3526
GG94	GONHER	MF-7404
GG986	GONHER	MF-986
GH2827	GUIOT	ML-8
GH8000	GUIOT	ML-8
GL286	GIF-FILTER	ML-8
GL512	GIF-FILTER	ML-8
GL682	GIF-FILTER	ML-8
GL682	PERMATIC	ML-8
GPI	GONHER	ML-8
GPI3	GONHER	ML-13
GPI49	GONHER	ML-3593
GP228	GONHER	ML-8
GP24	GONHER	ML-2849
GP28	GONHER	ML-5552
GP2825	GONHER	ML-5552
GP320	GONHER	ML-3593
GP321	GONHER	ML-6355
GP3600	GONHER	ML-3600
GP3682	GONHER	ML-3682
GP37	GONHER	ML-3682

CROSS	MARCA	MILLARD
GP3980	GONHER	ML-5934
GP3985	GONHER	ML-5566
GP405	GONHER	ML-10060
GP406	GONHER	ML-10060
GP407	GONHER	ML-64846
GP428	GONHER	ML-5548
GP430	GONHER	ML-5552
GP46	GONHER	ML-3387
GP58	GONHER	ML-3614
GP58GOLD	GONHER	ML-3614
GP58GOLD	GONHER	ML-3614
GP68	GONHER	ML-2
GP6811	GONHER	ML-3593
GP81	GONHER	ML-3614
GP9	GONHER	ML-4847
GP91	GONHER	ML-6607
H1540PLC004	HONDA	ML-3593
H17W	HENGST	ML-8
H17W01	HENGST	ML-8
H17W02	HENGST	ML-8
H17W03	HENGST	ML-8
H17W05	HENGST	ML-8
H17W08	HENGST	ML-8
H17W15	HENGST	ML-8
H17W18	HENGST	ML-8
H17WK05	HENGST	ML-8
H205W01	HENGST	ML-8
H62	BOSCH	ML-8
HC2	AC DELCO	ML-8
HCAK253	FRAM	MK-253
HGX8	FRANIG	ML-8
HE1923603	FORD	MK-8970
HE1923603	MAZDA	MK-8970
HE19236039A	MAZDA	MK-8970
HE1923802	MAZDA	ML-6607
HF6351	FLEETGUARD	ML-8
HPI	FRAM	ML-88227
HPI	FRAM	ML-8
HPI	LUBER-FINER	ML-8
I15360	GRAVELY	ML-8
IBE1047	INTERFIL	MK-6591
IBE1603	INTERFIL	MK-7756
J01397803	HYUNDAI	MK-253
J0927787	MAZDA	ML-88227

CROSS	MARCA	MILLARD
J0927787	MAZDA	ML-8
J0936406	MAZDA	ML-88227
J0936406	MAZDA	ML-8
J0938143	MAZDA	ML-88227
J0938143	MAZDA	ML-8
J131101	JAKOPARTS	ML-8
J131101	NIPPARTS	ML-8
J1311010	JAKOPARTS	ML-8
J1311010	NIPPARTS	ML-8
J1311027	JAKOPARTS	ML-8
J1311032	JAKOPARTS	ML-8
J1311032	NIPPARTS	ML-8
J1312006	JAKOPARTS	ML-8
J1312006	NIPPARTS	ML-8
J131206	NIPPARTS	ML-8
J1560025010	VW GROUP	ML-16
J1780135020	VW GROUP	MK-64676
J2330364010	VW GROUP	MF-4922
J2330364020	VW GROUP	MF-4922
J3153230	MOPAR	ML-8
J3250334	CHRYSLER	ML-5552
J8990499	MOPAR	ML-8
J9091520001	VW GROUP	ML-20004
J9091520003	VW GROUP	ML-3614
J96827723	CHEVROLET	MK-92369
J96827723	CHEVROLET	ML-92095
JE4813Z40	MAZDA	MK-64676
JEY014302	MAZDA	ML-3593
JEY0143029A	MAZDA	ML-3593
JEY014302A	MAZDA	ML-3593
JEY014302	MAZDA	ML-3593
JFO0101	WEGA	ML-8
JFO0216	WEGA	ML-8
JFO101	JAPAN PARTS	ML-8
JFO112	JAPAN PARTS	ML-8
JFO204	JAPAN PARTS	ML-8
JFO206	JAPAN PARTS	ML-8
JZW819653A	VW GROUP	MC-9323C
KO4105409AB	FIAT	ML-3614
KO4781452AB	FIAT	ML-3600
KO4781452BB	FIAT	ML-3600
KO4891695AA	FIAT	MK-10118
KO5018777AB	FIAT	MK-18777
KO5117492AA	FIAT	MF-73138

CROSS	MARCA	MILLARD
K05175429AB	FIAT	MF-73138
K05183748AA	FIAT	ML-9090
K1	KENDALL	ML-8
K4105409AB	FIAT	ML-3614
K46723570	KIA	MF-4886
K4781452AA	FIAT	ML-3600
K4781452BB	FIAT	ML-3600
K5018777AB	FIAT	MK-18777
K5183748AA	FIAT	ML-9090
K53004383	FIAT	MK-3901
K53004383AB	FIAT	MK-3901
K53007386AB	FIAT	MK-7440
K55114302	KIA	ML-42040
K68001297AA	FIAT	ML-9463
K71775180	FIAT	ML-9090
KC5042	LETOURNEAU WESTING.	ML-8
KJ0113Z40	MAZDA	MK-5466
KKY0114302	KIA	ML-6607
KL0714302B	FORD	ML-3593
KL4713Z40	MAZDA	MK-7344
KL4713Z409A	MAZDA	MK-7344
L1	KRALINATOR	ML-8
L130	KRALINATOR	ML-8
L17582	PUROLATOR	ML-8
L22	KRALINATOR	ML-8
L25401	PUROLATOR	ML-8
L30001	PUROLATOR PERU	ML-8
L30119	PUROLATOR PERU	ML-8
L30257	PUROLATOR	ML-8
L32114302	MAZDA	ML-321
L321143029A	MAZDA	ML-321
L334	LUBER-FINER	ML-8
L37031	PUROLATOR	ML-8
L37225	PUROLATOR	ML-8
L37755	PUROLATOR	ML-8
L38257	PUROLATOR	ML-8
L38258	PUROLATOR	ML-8
L39001	PUROLATOR	ML-8
L40A	KRALINATOR	ML-8
L45	KRALINATOR	ML-8
L61	KRALINATOR	ML-8
L64	KRALINATOR	ML-8
L76A	KRALINATOR	ML-8
LB2220	VOX	ML-8

CROSS	MARCA	MILLARD
LF0114302	MAZDA	ML-321
LF01143029A	MAZDA	ML-321
LF0514302A	MAZDA	ML-3614
LF1014302	MAZDA	ML-20004
LF10143029A	MAZDA	ML-3614
LF10143029B	MAZDA	ML-3614
LF1014302A	MAZDA	ML-3614
LF15	HASTINGS	ML-8
LF1A	LYS	ML-8
LF3313	FLEETGUARD	ML-8
LF3314	FLEETGUARD	ML-8
LF3324	FLEETGUARD	ML-8
LF3401	FLEETGUARD	ML-8
LF3402	FLEETGUARD	ML-8
LF3449	FLEETGUARD	ML-8
LF3451	FLEETGUARD	ML-8
LF3466	FLEETGUARD	ML-8
LF3487	FLEETGUARD	ML-8
LF3530	FLEETGUARD	ML-8
LF3685	FLEETGUARD	ML-8
LF50113Z40A	MAZDA	MK-96431
LF5013Z409A	MAZDA	MK-96431
LF5013Z40A	MAZDA	MK-96431
LF551	FLEETGUARD	ML-8
LF551A	FLEETGUARD	ML-8
LFP1	LUBER-FINER	ML-8
LFP19	LUBER-FINER	ML-8
LFP2538	LUBER-FINER	ML-8
LFP3411	LUBER-FINER	ML-8
LFP3411	WINNER	ML-8
LFP8509	LUBER-FINER	ML-8
LFY114302	MAZDA	ML-3614
LI2687	FISPA	ML-8
LI2687	PUROLATOR	ML-8
LI3855	PUROLATOR	ML-8
LI4054	FISPA	ML-8
LI911421	UNICO	ML-8
LI9144	UNICO	ML-8
LI91441	UNICO	ML-8
LI914425	UNICO	ML-8
LI914481	UNICO	ML-8
LK1161	AP LOCKHEED	ML-8
LK3151A	AP LOCKHEED	ML-8
LK3194A	AP LOCKHEED	ML-8

CROSS	MARCA	MILLARD
LK3252A	AP LOCKHEED	ML-8
LP2596	VW GROUP	ML-3614
LS165	PURFLUX	ML-8
LS210	CHAMP	ML-8
LS23	CHAMP	ML-8
LS274	PURFLUX	ML-8
LS274A	PURFLUX	ML-8
LS278	PURFLUX	ML-8
LS412	PURFLUX	ML-8
LS415	PURFLUX	ML-8
LS453A	PURFLUX	ML-8
LS494	PURFLUX	ML-8
LS553	PURFLUX	ML-8
LS553B	PURFLUX	ML-8
LS553C	PURFLUX	ML-8
LS717	PURFLUX	ML-8
LS753	PURFLUX	ML-8
LSF5001	COOPERS	ML-8
LSF5003	COOPERS	ML-8
M1500A098	MITSUBISHI	MK-51943
M2901	MIGHTY	ML-8
M349150AA	FORD	MF-4922
M806418	MITSUBISHI	ML-6607
M851139	MITSUBISHI	ML-5796
M852065	MITSUBISHI	ML-5796
M883804	MITSUBISHI	ML-5796
MB220900	MITSUBISHI	MF-4886
MB355667	MITSUBISHI	MF-3541
MB504746	MITSUBISHI	MF-3541
MB504753	MITSUBISHI	MF-3541
MB504756	MITSUBISHI	MF-3541
MB504761	MITSUBISHI	MF-3541
MB658689	MITSUBISHI	MF-3541
MB868451	MITSUBISHI	MF-3541
MB868454	MITSUBISHI	MF-3541
MB878451	MITSUBISHI	MF-3541
MB906051	MITSUBISHI	MK-7344
MB906052	MITSUBISHI	MK-7344
MD05281090	MITSUBISHI	ML-3593
MD069782	MITSUBISHI	ML-6355
MD069783	MITSUBISHI	ML-6355
MD135737	MITSUBISHI	ML-3593
MD184086	MITSUBISHI	ML-6355
MD320276	MITSUBISHI	ML-3593

CROSS	MARCA	MILLARD
MD321589	MITSUBISHI	ML-3593
MD325714	MITSUBISHI	ML-3593
MD348631	MITSUBISHI	ML-6607
MD352627	MITSUBISHI	ML-3593
MD360935	MITSUBISHI	ML-3593
MD603346	MITSUBISHI	MK-253
MD603446	MITSUBISHI	MK-253
MD603629	MITSUBISHI	MK-6362
MD603932	MITSUBISHI	MK-6362
MD620385	MITSUBISHI	MK-6362
MD620456	MITSUBISHI	MK-7142
MD620472	MITSUBISHI	MK-7142
MD620596	MITSUBISHI	MK-7344
ME013307	MITSUBISHI	ML-6355
MF45700A	PUROLATOR	ML-8
MF4886	MITSUBISHI	MF-4886
MH301	M-FILTER	ML-8
MH347	M-FILTER	ML-8
MH370	M-FILTER	ML-8
MH379	M-FILTER	ML-8
MHK6714A	FORD	ML-88227
MHK6714A	FORD	ML-8
MIK08202	MIKFIL	ML-8
ML78049	MASERATI	ML-8
ML8	MILLARD	ML-8
MLS000186	CITROËN	ML-8
MM130481	MITSUBISHI	MK-253
MN8	MARTIN BROTHERS	ML-8
MN980125	MITSUBISHI	ML-9463
MN980408	MITSUBISHI	ML-9463
MN982159	MITSUBISHI	ML-9814
MN982380	MITSUBISHI	ML-9814
MO1117	M-FILTER	ML-8
MO5281090	MITSUBISHI	ML-3614
MOF17X	GKN MASTERPARTS	ML-8
MOF61X	GKN MASTERPARTS	ML-8
MR127077	MITSUBISHI	MK-3901
MR188657	MITSUBISHI	MK-8208
MR204132	MITSUBISHI	MF-4132
MR239024	MITSUBISHI	MK-3901
MR258421	MITSUBISHI	MK-8208
MR373756	MITSUBISHI	MK-8208
MR464177	MITSUBISHI	MK-8208
MR481794	MITSUBISHI	MK-8208

CROSS	MARCA	MILLARD
MR481795	MITSUBISHI	MK-8208
MR552951	MITSUBISHI	MK-8208
MR571471	MITSUBISHI	MK-7142
MR571477	MITSUBISHI	MK-6362
MR984204	MITSUBISHI	ML-3593
MZ311782	MITSUBISHI	MK-7344
MZ311782T	MITSUBISHI	MK-7344
MZ311783	MITSUBISHI	MK-7142
MZ311783T	MITSUBISHI	MK-7142
MZ311788	MITSUBISHI	MK-6362
MZ311790	MAZDA	MK-253
MZ311790	MITSUBISHI	MK-253
MZ690070	MITSUBISHI	ML-3593
MZ690071	MITSUBISHI	ML-6355
MZ690072	MITSUBISHI	ML-3593
MZ690115	MITSUBISHI	ML-3593
MZ690116	MITSUBISHI	ML-3593
MZ690194	MITSUBISHI	MK-7142
MZ690445	MITSUBISHI	MK-41437
N23123802	MAZDA	ML-6607
N35014302	MAZDA	ML-6607
N3Y614302	MAZDA	ML-6607
NL8A	NOMIS	ML-8
NO8	NKE	ML-8
O1	SUNOCO	ML-8
O10	SUNOCO	ML-8
O1626	MICRO	ML-8
O1A	SUNOCO	ML-8
O626	BOSCH	ML-8
OB63114302	KIA	ML-6607
OC116	MAHLE	ML-8
OC125	KNECHT	ML-8
OC125	MAHLE	ML-8
OC241	MAHLE	ML-8
OC249	MAHLE	ML-8
OC257	MAHLE	ML-8
OC311	MAHLE	ML-8
OC33	MAHLE	ML-8
OC37	MAHLE	ML-8
OC51	MAHLE	ML-8
OC51	PERFECT CIRCLE	ML-8
OC51OF	KNECHT	ML-8
OC51OF	MAHLE	ML-8
OC51OF	PERFECT CIRCLE	ML-8

CROSS	MARCA	MILLARD
OC59	MAHLE	ML-8
OC61	MAHLE	ML-8
OC67	MAHLE	ML-8
OF10060	INTERFIL	ML-10060
OF10246	INTERFIL	ML-19626
OF10295	INTERFIL	ML-12027
OF10358	INTERFIL	ML-96796
OF10575	INTERFIL	ML-10060
OF10890	INTERFIL	ML-13875
OF11	INTERFIL	ML-13
OF1109	INTERFIL	ML-9443
OF11T0	INTERFIL	ML-5566
OF11Z1	INTERFIL	ML-9814
OF11Z5	INTERFIL	ML-96571
OF1216	INTERFIL	ML-12775
OF13	INTERFIL	ML-13
OF1520	INTERFIL	ML-16
OF16	INTERFIL	ML-16
OF1601	INTERFIL	ML-50145
OF2	INTERFIL	ML-2
OF200	INTERFIL	ML-9432
OF2092	INTERFIL	ML-9540
OF25	INTERFIL	ML-30
OF2500	INTERFIL	ML-3593
OF2518	INTERFIL	ML-92095
OF2815	INTERFIL	ML-88227
OF2825	INTERFIL	ML-3600
OF2870	INTERFIL	ML-5552
OF2870	INTERFIL	ML-2870
OF2870D	INTERFIL	ML-5552
OF2933	INTERFIL	ML-933
OF2951	INTERFIL	ML-4967
OF2Q67	INTERFIL	ML-10060
OF30	INTERFIL	ML-30
OF3387	INTERFIL	ML-3387
OF3506	INTERFIL	ML-4952
OF3535	INTERFIL	ML-3980
OF3593	INTERFIL	ML-3593
OF3593H	INTERFIL	ML-3807
OF3600	INTERFIL	ML-3600
OF3614	INTERFIL	ML-3614
OF3675	INTERFIL	ML-3675
OF3682	INTERFIL	ML-3614
OF3682	INTERFIL	ML-3682

CROSS	MARCA	MILLARD
OF3690	INTERFIL	ML-3690
OF3950	INTERFIL	ML-3950
OF3976	INTERFIL	ML-3976
OF3980	INTERFIL	ML-5934
OF3980	INTERFIL	ML-3980
OF3C11	INTERFIL	ML-52149
OF3L62	INTERFIL	ML-50629
OF4177	INTERFIL	ML-57961
OF4240	INTERFIL	ML-42040
OF43	INTERFIL	ML-4847
OF43	INTERFIL	ML-43
OF4386	INTERFIL	ML-5166
OF4558	INTERFIL	ML-4558
OF4858	INTERFIL	ML-5796
OF4967	INTERFIL	ML-4967
OF5	INTERFIL	ML-13
OF5403	INTERFIL	ML-64846
OF5548D	INTERFIL	ML-5548
OF5562	INTERFIL	ML-14120
OF6103	INTERFIL	ML-56155
OF6607	INTERFIL	ML-6607
OF6714	INTERFIL	ML-2
OF6744	INTERFIL	ML-67340
OF6848	INTERFIL	ML-6848
OF6C67	INTERFIL	ML-9814
OF7300	INTERFIL	ML-9713
OF7317	INTERFIL	ML-3593
OF8	INTERFIL	ML-8
OF8081	INTERFIL	ML-67845
OF8316	INTERFIL	ML-3600
OF8398	INTERFIL	ML-4558
OF8481	INTERFIL	ML-9090
OF8530	INTERFIL	ML-8530
OF8776	INTERFIL	ML-9090
OF8994	INTERFIL	ML-16
OF8994	INTERFIL	ML-8
OF9011	INTERFIL	ML-2975
OF9018	INTERFIL	ML-9018
OF9100	INTERFIL	ML-13
OF927	INTERFIL	ML-5796
OF9301	INTERFIL	ML-9090
OF9461	INTERFIL	ML-9463
OF9566	INTERFIL	ML-3614
OF9641	INTERFIL	ML-321

CROSS	MARCA	MILLARD
OF966	INTERFIL	ML-3614
OF966	INTERFIL	ML-5166
OF9954	INTERFIL	ML-14120
OF9972	INTERFIL	ML-44155
OJE1514302	HYUNDAI	ML-3593
OJE1514302	KIA	ML-3593
OK14	TEHO FILTER	ML-8
OK2	TEHO FILTER	ML-8
OK2A513Z40	KIA	MK-8548
OK2A513Z40A	KIA	MK-8548
OK41023802A	KIA	ML-6607
OK46723570	KIA	MF-4886
OK55114302	KIA	ML-42040
OK61	TEHO FILTER	ML-8
OK89	TEHO FILTER	ML-8
OL194	TECNECO	ML-8
OL299	TECNECO	ML-8
OL40	TECNECO	ML-8
OL49	TECNECO	ML-8
OLP008	PREMIUM FILTERS	ML-8
OP525	FILTRON	ML-8
OP5262	FILTRON	ML-8
OP531	FILTRON	ML-8
OP549	FILTRON	ML-8
OP563	FILTRON	ML-8
OR502	FAPOFIL	ML-8
OVS0114302	KIA	ML-6355
P10148	FRAM	MF-73138
P1121	FRAM	MF-29341
P2001	BOSCH	ML-8
P2150	GOULD	ML-8
P3012	BOSCH	ML-8
P3253	BOSCH	ML-8
P3346	BOSCH	ML-8
P3380	FRAM	MF-29341
P341	GOULD	ML-8
P366	GOULD	ML-8
P4063	BOSCH	ML-8
P4101	FRAM	ML-88227
P4101A	FRAM	ML-88227
P452	GOULD	ML-8
P454	GOULD	ML-8
P470	LATHROP	ML-8
P4720364	CHRYSLER	ML-5552

CROSS	MARCA	MILLARD
P4886	FRAM	MF-4886
P4922	FRAM	MF-4922
P5138	FRAM	MF-5138
P5162	FRAM	MF-29882
P5226	FRAM	MF-5138
P550008	DONALDSON	ML-8
P553210	DONALDSON	ML-8
P553314	DONALDSON	ML-8
P553411	DONALDSON	ML-8
P557780	DONALDSON	ML-8
P6809	FRAM	ML-88227
P7227	FRAM	ML-88227
P779126	DONALDSON	ML-8
P779149	DONALDSON	ML-8
P779181	DONALDSON	ML-8
P779198	DONALDSON	ML-8
P779204	DONALDSON	ML-8
P8451	FRAM	MF-29341
PA7135	FRAM	MK-5377
PC225	PUROLATOR	ML-8
PC25	PUROLATOR	ML-8
PC257	PUROLATOR	ML-8
PC31	PUROLATOR	ML-8
PC34	PUROLATOR	ML-8
PC341	PUROLATOR	ML-8
PEB313Z40	MAZDA	MK-5682
PER1	PUROLATOR PERU	ML-8
PER119	PUROLATOR PERU	ML-8
PER1A	PUROLATOR PERU	ML-8
PER83	PUROLATOR	ML-8
PEY014302	MAZDA	ML-3593
PEYO14302	MAZDA	ML-3593
PFI	AC DELCO	ML-8
PFI4	AC DELCO	ML-8
PFI9	AC DELCO	ML-8
PFIHC	AC DELCO	ML-8
PF2	AC DELCO	ML-8
PF32	AC DELCO	ML-8
PF9	AC DELCO	ML-8
PF960	AC DELCO	ML-8
PH1	FRAM	ML-88227
PH1	FRAM	ML-8
PH10008	FRAM	ML-3387
PH10044	FRAM	ML-3614

CROSS	MARCA	MILLARD
PH10060	FRAM	ML-10060
PH10127	FRAM	ML-42040
PH10298	FRAM	ML-5552
PH10575	FRAM	ML-10060
PH10684	FRAM	ML-42040
PH11275	FRAM	ML-3593
PH11774	FRAM	ML-5796
PH12	FRAM	ML-88227
PH12	CHAMP	ML-8
PH12	FRAM	ML-8
PH12	LUBER-FINER	ML-8
PH13	FRAM	ML-13
PH14	FRAM	ML-13
PH16	FRAM	ML-16
PH19	FRAM	ML-88227
PH19	FRAM	ML-8
PH19A	FRAM	ML-88227
PH2	FRAM	ML-2
PH25	FRAM	ML-13
PH2701	LUBER-FINER	ML-8
PH2800	FRAM	ML-16
PH28001	FRAM	ML-16
PH2802	FRAM	ML-88227
PH2802	FRAM	ML-8
PH2803	FRAM	ML-88227
PH2803	FRAM	ML-8
PH28032	FRAM	ML-88227
PH28032	FRAM	ML-8
PH2806	FRAM	ML-88227
PH2806	FRAM	ML-8
PH2809	FRAM	ML-16
PH2811	FRAM	ML-16
PH2811N	FRAM	ML-16
PH2815	FRAM	ML-88227
PH2815	CHAMP	ML-8
PH2815	FRAM	ML-8
PH2815	LUBER-FINER	ML-8
PH2817	FRAM	ML-16
PH2818	FRAM	ML-16
PH2821	FRAM	ML-88227
PH2821	FRAM	ML-8
PH2821A	FRAM	ML-88227
PH2821A	CHAMP	ML-8
PH2821A	FRAM	ML-8

CROSS	MARCA	MILLARD
PH2821A	LUBER-FINER	ML-8
PH2823	FRAM	ML-16
PH2823	FRAM	ML-88227
PH28231	FRAM	ML-16
PH2824	FRAM	ML-88227
PH2825	FRAM	ML-3682
PH2825A	FRAM	ML-3682
PH2827	FRAM	ML-88227
PH2827	FRAM	ML-8
PH2828	FRAM	ML-88227
PH2828	FRAM	ML-8
PH2830	FRAM	ML-16
PH2831	FRAM	ML-16
PH2833	FRAM	ML-16
PH2834	FRAM	ML-3614
PH2840	FRAM	ML-88227
PH2844	FRAM	ML-16
PH2849A	FRAM	ML-2849
PH2850	FRAM	ML-88227
PH2850	FRAM	ML-8
PH2850	LUBER-FINER	ML-8
PH2854	FRAM	ML-3614
PH2854RN	FRAM	ML-16
PH2857	FRAM	ML-16
PH2857A	FRAM	ML-16
PH2858	FRAM	ML-88227
PH2858	FRAM	ML-8
PH2861B	FRAM	ML-16
PH2862	FRAM	ML-3387
PH2862A	FRAM	ML-3387
PH2863	FRAM	ML-16
PH28631	FRAM	ML-16
PH2868	FRAM	ML-16
PH2870A	FRAM	ML-5552
PH2871	FRAM	ML-3593
PH2872	FRAM	ML-3614
PH2875	FRAM	ML-5552
PH2879	FRAM	ML-16
PH2881	FRAM	ML-88227
PH2881	FRAM	ML-8
PH2884	FRAM	ML-3614
PH2886	FRAM	ML-3682
PH2898	FRAM	ML-3387
PH2919	FRAM	ML-16

CROSS	MARCA	MILLARD
PH2921	FRAM	ML-3593
PH2928	FRAM	ML-4952
PH2942	FRAM	ML-3614
PH2951	FRAM	ML-3614
PH2956	FRAM	ML-3614
PH2957	FRAM	ML-5552
PH2958	FRAM	ML-4952
PH2964	FRAM	ML-3614
PH2966	FRAM	ML-3614
PH2978	FRAM	ML-16
PH2985	FRAM	ML-3682
PH2991	FRAM	ML-3600
PH2992A	FRAM	ML-5796
PH2993	FRAM	ML-3614
PH2993A	FRAM	ML-16
PH2996	FRAM	ML-88227
PH2996	FRAM	ML-8
PH2996A	FRAM	ML-88227
PH2996A	FRAM	ML-8
PH3	FRAM	ML-88227
PH3	FRAM	ML-8
PH3387	FRAM	ML-3387
PH3387A	FRAM	ML-3387
PH3429	FRAM	ML-3675
PH35	FRAM	ML-16
PH3506	FRAM	ML-4952
PH3512	FRAM	ML-5796
PH3569	FRAM	ML-88227
PH3569	FRAM	ML-8
PH3569A	FRAM	ML-88227
PH3600	FRAM	ML-3600
PH3614	FRAM	ML-3614
PH3675	FRAM	ML-3675
PH3682	FRAM	ML-3682
PH3807	FRAM	ML-3593
PH3807A	FRAM	ML-3593
PH3900	FRAM	ML-3976
PH3917	FRAM	ML-3593
PH3976	FRAM	ML-3976
PH3976A	FRAM	ML-3976
PH3985	FRAM	ML-5796
PH4386	FRAM	ML-5166
PH4468	FRAM	ML-3614
PH4478	FRAM	ML-3614

CROSS	MARCA	MILLARD
PH4546	FRAM	ML-5796
PH4547	FRAM	ML-5796
PH4548	FRAM	ML-5796
PH4589	FRAM	ML-5552
PH46	FRAM	ML-3614
PH4678	FRAM	ML-16
PH4681	FRAM	ML-5552
PH46A	FRAM	ML-3614
PH47	FRAM	ML-3387
PH4702	FRAM	ML-3682
PH4703	FRAM	ML-5566
PH4722	FRAM	ML-3387
PH4743	FRAM	ML-88227
PH4751	FRAM	ML-4952
PH4765	FRAM	ML-3387
PH4824	FRAM	ML-3614
PH4825	FRAM	ML-88227
PH4825	FRAM	ML-8
PH4826	FRAM	ML-5566
PH4835	FRAM	ML-4952
PH4847	FRAM	ML-4847
PH4847A	FRAM	ML-4847
PH4854	FRAM	ML-88227
PH4861	FRAM	ML-5552
PH4913	FRAM	ML-3593
PH4952	FRAM	ML-4952
PH4967	FRAM	ML-4967
PH4985	FRAM	ML-20004
PH4998	FRAM	ML-6607
PH49A	FRAM	ML-49
PH5	FRAM	ML-13
PH5100	FRAM	ML-4847
PH5102	FRAM	ML-4847
PH5112	FRAM	ML-3614
PH5113	FRAM	ML-5796
PH5114	FRAM	ML-5566
PH5117	FRAM	ML-88227
PH5139	FRAM	ML-5566
PH5166	FRAM	ML-5166
PH5172	FRAM	ML-16
PH5196	FRAM	ML-3593
PH5197	FRAM	ML-5796
PH5210	FRAM	ML-3600
PH5230	FRAM	ML-5796

CROSS	MARCA	MILLARD
PH5280	FRAM	ML-3593
PH5299	FRAM	ML-20004
PH5300	FRAM	ML-20004
PH5317	FRAM	ML-3593
PH5343	FRAM	ML-3593
PH5354	FRAM	ML-5796
PH5365	FRAM	ML-3614
PH5394	FRAM	ML-49
PH5414	FRAM	ML-5552
PH5439	FRAM	ML-3614
PH5443	FRAM	ML-16
PH5458	FRAM	ML-5566
PH5479	FRAM	ML-5796
PH5480	FRAM	ML-5566
PH5491	FRAM	ML-88227
PH5548	FRAM	ML-5548
PH5550	FRAM	ML-3614
PH5552	FRAM	ML-5552
PH5556	FRAM	ML-3614
PH5566	FRAM	ML-5566
PH5566A	FRAM	ML-5566
PH5616	FRAM	ML-4847
PH5645	FRAM	ML-3387
PH5660	FRAM	ML-3614
PH5675	FRAM	ML-5566
PH5676	FRAM	ML-5566
PH5713	FRAM	ML-3614
PH5795	FRAM	ML-5796
PH57951	FRAM	ML-5796
PH5796	FRAM	ML-5796
PH57961	FRAM	ML-5796
PH5803	FRAM	ML-3600
PH5803	FRAM	ML-5552
PH5822	FRAM	ML-3614
PH5831	FRAM	ML-5566
PH5832	FRAM	ML-16
PH5834	FRAM	ML-5796
PH5883	FRAM	ML-16
PH5911	FRAM	ML-5796
PH5934	FRAM	ML-5934
PH5975	FRAM	ML-5548
PH6017A	FRAM	ML-6607
PH6355	FRAM	ML-6355
PH6607	FRAM	ML-6607

CROSS	MARCA	MILLARD
PH6682	FRAM	ML-5552
PH7317	FRAM	ML-3593
PH7328	FRAM	ML-16
PH7498	FRAM	ML-16
PH8	FRAM	ML-88227
PH8	CAR-VENEZUELA	ML-8
PH8	FRAM	ML-8
PH8316	FRAM	ML-5552
PH8830	FRAM	ML-4952
PH8936	FRAM	ML-6355
PH8940	FRAM	ML-5548
PH8993	FRAM	ML-5548
PH8A	FRAM	ML-88227
PH8A	FRAM	ML-8
PH8A	LUBER-FINER	ML-8
PH8A	WINNER	ML-8
PH9	FRAM	ML-16
PH9104	FRAM	ML-3614
PH9105	FRAM	ML-3614
PH927	FRAM	ML-16
PH927PL	FRAM	ML-16
PH9460	FRAM	ML-3614
PH9536	FRAM	ML-9018
PH9566	FRAM	ML-3614
PH9599	FRAM	ML-5566
PH961	FRAM	ML-16
PH964PL	FRAM	ML-16
PH966	FRAM	ML-3614
PH966B	FRAM	ML-3614
PH966B1	FRAM	ML-3614
PH966B11	FRAM	ML-3614
PH9727	FRAM	ML-5566
PH9739	FRAM	ML-5796
PH9763	FRAM	ML-5566
PH977	FRAM	ML-88227
PH977A	FRAM	ML-88227
PH9837	FRAM	ML-3675
PH9908	FRAM	ML-5166
PH9A	FRAM	ML-16
PH9A1	FRAM	ML-16
PH9B	FRAM	ML-16
PH9B1	FRAM	ML-16
PH9W	FRAM	ML-16
PH9W1	FRAM	ML-16

CROSS	MARCA	MILLARD
PIL24	PUROLATOR	ML-8
PIL30	PUROLATOR	ML-8
PIL38	PUROLATOR	ML-8
PL3313	AIR REFINER	ML-8
PL8	LEE MARTIN	ML-8
PLB3651	PENTIUS	ML-8
PLB8A	PENTIUS	ML-8
PM366	CYCLONE	ML-8
PM5754	FRAM	ML-5566
PMFL56	POWERTRAIN	ML-8
PP82	WYTWORNIA FILTROW	ML-8
PP87A	WYTWORNIA FILTROW	ML-8
PS10396	FRAM	MF-4886
PS4886	FRAM	MF-4886
PS4922	FRAM	MF-4922
PS5917	FRAM	MF-5138
PSL714	TEC-FIL	ML-8
PSL900	TEC-FIL	ML-8
PZ1	PENNZOIL	ML-8
PZ11	PENNZOIL	ML-8
PZ22	PENNZOIL	ML-8
Q0950558	POCLAIN	ML-8
Q0950559	POCLAIN	ML-8
QOF5400	QUINTON HAZELL	ML-8
QS19	QUAKER STATE	ML-8
QS3569	QUAKER STATE	ML-8
QS8A	QUAKER STATE	ML-8
R194	TECNOCAR	ML-8
R1A	FOMOCO	ML-8
R2154	RYCO	ML-8
R255	TECNOCAR	ML-8
R266	TECNOCAR	ML-8
R299	TECNOCAR	ML-8
R2N13ZA5	MAZDA	MF-4922
R2N513ZA5	MAZDA	MF-4922
R2N513ZA59A	MAZDA	MF-4922
R2N513ZA5A	MAZDA	MF-4922
R2N513ZA5A9A	MAZDA	MF-4922
R405	TECNOCAR	ML-8
R49	TECNOCAR	ML-8
R65	TECNOCAR	ML-8
RF7113480A	MAZDA	MF-4886
RF8313ZA5	MAZDA	MF-4886
RFY0143029A	MAZDA	ML-3593

CROSS	MARCA	MILLARD
RV32	WISCONSIN	ML-8
RV32S	WISCONSIN	ML-8
S2630002501	HYUNDAI	ML-3593
S2630035A00	HYUNDAI	ML-3593
S3102R	SOFIMA	ML-8
S3103R	SOFIMA	ML-8
S3181R	SOFIMA	ML-8
S3241R	SOFIMA	ML-8
S3297R	SOFIMA	ML-8
S3582R2	SOFIMA	ML-8
S5600R	SOFIMA	ML-8
S5601R	SOFIMA	ML-8
S5603R	SOFIMA	ML-8
S6620R	SOFIMA	ML-8
S83CPA	WGB	ML-8
SAK702	SCHLUETER	ML-8
SC	AC DELCO	ML-8
SE020030288A	VW GROUP	ML-3614
SE021030288	VW GROUP	ML-5552
SE021030288A	VW GROUP	ML-5552
SE0211004653A	VW GROUP	MF-5030
SE021104653A	VW GROUP	MF-5030
SE028030288A	VW GROUP	ML-3614
SE700030288A	VW GROUP	ML-16
SFO1A	SURE FILTERS	ML-8
SLB0715	IMPECA	ML-8
SM108	SCT GERMANY	ML-8
SM133	SCT GERMANY	ML-8
SMD360935	MITSUBISHI	ML-3593
SO041	SAVARA	ML-8
SO053	SAVARA	ML-8
SO223	SAVARA	ML-8
SO404	SAVARA	ML-8
SO851	SAVARA	ML-8
SP	AC DELCO	ML-8
SP401	ASAS	ML-8
SP4055	SCHUPP / SF FILTER	ML-8
SP4330	SCHUPP / SF FILTER	ML-8
SP468030	SCHUPP / SF FILTER	ML-8
SP5212	SCHUPP / SF FILTER	ML-8
SP801	ALCO FILTERS	ML-8
SP837	ALCO FILTERS	ML-8
SP853	ALCO FILTERS	ML-8
SP901	ALCO FILTERS	ML-8

CROSS	MARCA	MILLARD
SP915	ALCO FILTERS	ML-8
SP916	ALCO FILTERS	ML-8
SP920	ALCO FILTERS	ML-8
SP979	ALCO FILTERS	ML-8
SP980	ALCO FILTERS	ML-8
SPA	AC DELCO	ML-8
SU00100453	TOYOTA	ML-5566
SU001A0178	TOYOTA	ML-9814
SU0030031900	TOYOTA	MK-9482
SW6920	VERSATILE	ML-8
TI	ICOFIL	ML-8
TI5098	THWAITES	ML-8
TI623	MICRO	ML-8
TAMTI6N- 619F2CS	FORD	MC-67836C
TN08	TOYONIC	ML-8
TO118	AMC FILTERS	ML-8
TY9425	JOHN DEERE	ML-8
UA102	BARDFIL (BARDAHL)	ML-8
UPH8A	UNIFIL	ML-8
V100321	VAICO	ML-8
V100327	VAICO	ML-8
V1F	BALDWIN	ML-8
V2F	BALDWIN	ML-8
VFL109	MOTAQUIP AAPCO	ML-8
VFL135	MOTAQUIP AAPCO	ML-8
VFL213	MOTAQUIP AAPCO	ML-8
VFL220	MOTAQUIP AAPCO	ML-8
VFL249	MOTAQUIP AAPCO	ML-8
VFL460	MOTAQUIP AAPCO	ML-8
VFL506	MOTAQUIP AAPCO	ML-8
VL8	VEGA	ML-8
VOFI09	OPEL	ML-8
VOFI09	VAUXHALL	ML-8
VPD5047	VAPORMATIC	ML-8
VPD5051	VAPORMATIC	ML-8
VSY114302	MAZDA	ML-6355
VSY114302A	MAZDA	ML-6355
VSY114302B	MAZDA	ML-6355
VSY314302	MAZDA	ML-6355
WI650569	POCLAIN	ML-8
W8	WEB	ML-8
W8004	MANN-FILTER	ML-8
W8006	MANN-FILTER	ML-8
W93012	MANN-FILTER	ML-8



CROSS	MARCA	MILLARD
W93020	MANN-FILTER	ML-8
W93021	MANN-FILTER	ML-8
W93281	MANN-FILTER	ML-8
W9331	MANN-FILTER	ML-8
W934	MANN-FILTER	ML-8
W93599	MFI	ML-8
W936	MANN-FILTER	ML-8
W9366	MANN-FILTER	ML-8
W940	MANN-FILTER	ML-8
W9401	MANN-FILTER	ML-8
W94013	MANN-FILTER	ML-8
W94015N	MANN-FILTER	ML-8
W94019	MANN-FILTER	ML-8
W94021	MANN-FILTER	ML-8
W94022	MANN-FILTER	ML-8
W94023	MANN-FILTER	ML-8
W94024	MANN-FILTER	ML-8
W94025	MANN-FILTER	ML-8
W94027	MANN-FILTER	ML-8
W9404	MANN-FILTER	ML-8
W94044	MANN-FILTER	ML-8
W94047	MANN-FILTER	ML-8
W94051	MANN-FILTER	ML-8
W94066	MANN-FILTER	ML-8
W94081	MANN-FILTER	ML-8
W9409	MANN-FILTER	ML-8
W941	MANN-FILTER	ML-8
W9504	MANN-FILTER	ML-8
W9505	MANN-FILTER	ML-8
W9507	MANN-FILTER	ML-8
WE0113ZA5A	MAZDA	MF-4922
WGL3313	WOODGATE	ML-8
WGL3314	WOODGATE	ML-8
WGL3402	WOODGATE	ML-8
WGL3451	WOODGATE	ML-8
WGL940	WOODGATE	ML-8
WL7068	WIX (EUROPE)	ML-8
WL7072	WIX (EUROPE)	ML-8
WL7075	WIX (EUROPE)	ML-8
WL7095	WIX (EUROPE)	ML-8
WL7096	QUINTON HAZELL	ML-8
WL7096	WIX (EUROPE)	ML-8
WL7321	WIX (EUROPE)	ML-8
WL8113ZA5	MAZDA	MF-4922

CROSS	MARCA	MILLARD
WL8414302	MAZDA	ML-88227
WL8414302	MAZDA	ML-8
WO350	WEGA	ML-8
WO590	WEGA	ML-8
WPH8A	WINNER	ML-8
X100	AC DELCO	ML-8
X11	AC DELCO	ML-8
X14	AC DELCO	ML-8
X150	AC DELCO	ML-8
X21	AC DELCO	ML-8
X29	AC DELCO	ML-8
X3549957	CHRYSLER	ML-16
X38	AC DELCO	ML-8
X4016E	AC DELCO	ML-8
X4017E	AC DELCO	ML-8
X4085E	AC DELCO	ML-8
X4088E	AC DELCO	ML-8
X4124E	AC DELCO	ML-8
X4125E	AC DELCO	ML-8
X4138E	AC DELCO	ML-8
X61	AC DELCO	ML-8
XB220900	MITSUBISHI	MF-4886
XB906051	MITSUBISHI	MK-7344
XD603932	MITSUBISHI	MK-6362
XD620456	MITSUBISHI	MK-7142
XE021030288	VW GROUP	ML-5552
XE021030288A	VW GROUP	ML-5552
XE028030288A	VW GROUP	ML-3614
XF529155BA	FORD	MF-986
XM349150AA	FORD	MF-4922
XM349159EA	FORD	MF-4922
XM3J6731FA	FORD	ML-88227
XM3J6731FA	FORD	ML-8
XM3J9150AA	FORD	MF-4922
XR127077	MITSUBISHI	MK-3901
XR188657	MITSUBISHI	MK-8208
XR552951	MITSUBISHI	MK-8208
XS4H16N619AB	FORD	MC-67836C
XS4H19G244AA	FORD	MC-67836C
XS4H19G244BA	FORD	MC-67836C
XS4H19G244CA	FORD	MC-67836C
XS5X9601DA	FORD	MK-9896
XS619155AA	FORD	MF-3526
XS6E6714B1A	FORD	ML-3600

CROSS	MARCA	MILLARD
XW4E6714BA	FORD	ML-2
XW4E6714DA	FORD	ML-2
XW4E6714EA	FORD	ML-3600
Y64513Z40	MAZDA	MK-26934
Y64513Z40A	MAZDA	MK-26934
YC3Z9601AA	FORD	MK-8004
YF0913Z40	MAZDA	MK-8997
YF0913Z40A	MAZDA	MK-8997
YF0914302	MAZDA	ML-5552
YF1Z9601AA	FORD	MK-8997
YL4J6714AA	FORD	ML-3682
YL4J6714CA	FORD	ML-88227
YL4J9155AA	FORD	MF-4777
YL4J9155BA	FORD	MF-5138
YL5Z9155AB	FORD	MF-4922
YL8Z9601AA	FORD	MK-8997
YL8Z9601AA	MAZDA	MK-8997
YM216744AA	FORD	ML-9463
YN2G6714838	FORD	ML-5552
YN2G6714B2A	FORD	ML-3600
YO101475	FBN	ML-8
YOT002	YUIL FILTERS	ML-8
YS4Z9601CC	FORD	MK-5929
YT0152	YUIL FILTERS	ML-8
Z102	MISFAT	ML-8
Z115	RYCO	ML-8
Z1159	COOPERS	ML-8
Z1289	COOPERS	ML-8
Z135	GUD	ML-8
Z139	RYCO	ML-8
Z1417	COOPERS	ML-8
Z164	MISFAT	ML-8
Z164A	MISFAT	ML-8
Z256	MISFAT	ML-8
Z358	GUD	ML-8
Z38	RYCO	ML-8
Z43	COOPERS	ML-8
Z47	COOPERS	ML-8
Z47	GUD	ML-8
Z510A	COOPERS	ML-8
Z7	COOPERS	ML-8
Z79	COOPERS	ML-8
Z831	COOPERS	ML-8
Z844	COOPERS	ML-8

CROSS	MARCA	MILLARD
Z877	COOPERS	ML-8
Z89	COOPERS	ML-8
Z9	RYCO	ML-8
ZL0113320B	MAZDA	MK-5595
ZO1101	ZIP	ML-8
ZO1204	ZIP	ML-8
ZO1302	ZIP	ML-8
ZP3502D	FIL FILTER	ML-8
ZZL013470	MAZDA	MF-3521
ZZL014302	MAZDA	ML-88227
ZZL014302	MAZDA	ML-8
ZZL013470	MAZDA	MF-3521
ZZM123802A	MAZDA	ML-5552
ZZMO13470	MAZDA	MF-800
ZZN123302	MAZDA	ML-5552
ZZP013470	MAZDA	MF-986
ZZP013480	MAZDA	MF-986
ZZP113470	MAZDA	MF-986
ZZP113480	MAZDA	MF-986

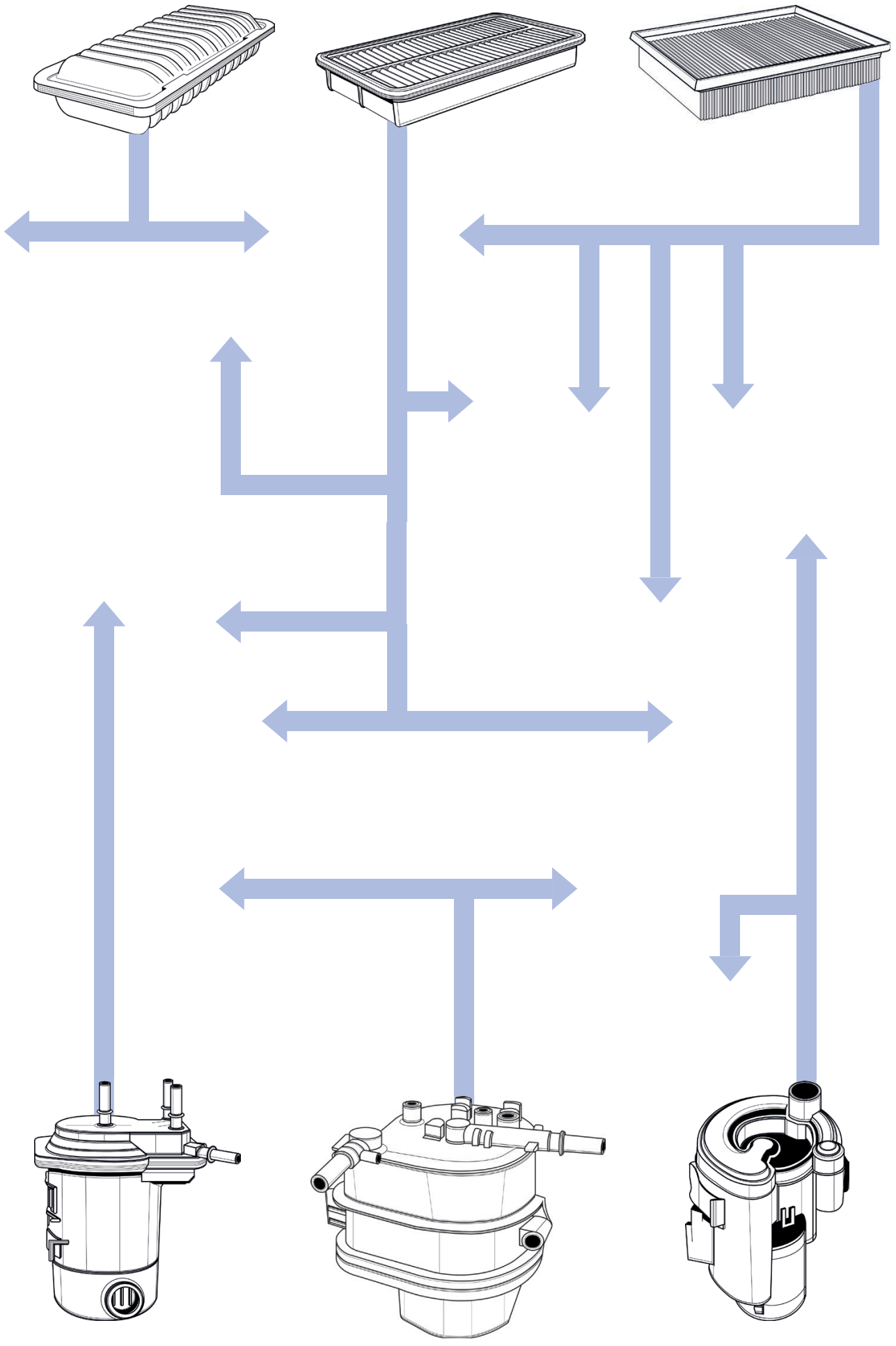

## BUENAS PRACTICAS MILLARD FILTERS PARA EL CAMBIO DE FILTROS

A continuación, se describen el conjunto de Buenas Prácticas que reconocemos como acciones que valorizan las operaciones de cambio de filtros de cualquier clase en nuestro automóvil, recordando que estas deben realizarse siempre respetando los intervalos de tiempo o recorrido recomendados por cada fabricante y para cada vehículo, en los espacios apropiados y con la herramienta adecuada.



### Atemperado del motor

El aceite caliente es más sencillo de retirar para realizar una restitución de filtro de aceite. Si el motor está frío, manténgalo funcionando al menos 10 minutos.

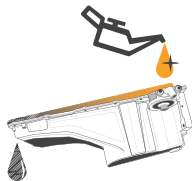

### Vaciado del aceite del cárter

Para no contaminar el nuevo elemento filtrante con aceite sucio, se recomienda drenar y reponer la totalidad del circuito de aceite con aceite nuevo.

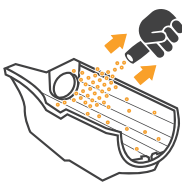

### Limpieza y aspirado de bases de montaje

Para la sustitución de filtros de aire o cabina, se debe realizar la limpieza de las carcasas o bases de montaje, para así evitar daños por los elementos que hayan quedado en el interior.

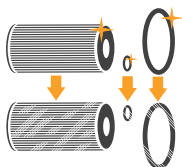

### Sustitución de elementos de sellado en bases de montaje

Asegúrese de restituir la totalidad del filtro, en algunos casos, el elemento filtrante incluye un elemento de sellado, este también debe sustituirse con la reposición del filtro.



### Lubricación de juntas y retenes

Antes del montaje de elementos filtrantes de aceite o combustible, se recomienda untar con el mismo producto a filtrar, las juntas de estanquidad del dispositivo para mejorar su capacidad de sellado.

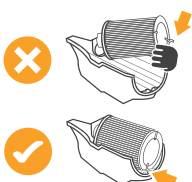

### Correcto posicionado del elemento filtrante

Especialmente en filtros "de cartucho" que van dentro de carcasas o tienen una posición concreta de montaje, es conveniente asegurar que esté en su lugar, de forma que su funcionalidad no se vea mermada.



### Cebado de filtros

Especialmente en filtros tipo "Spin On" es recomendable realizar un pre llenado del fluido trabajado, para que, en casos como filtros de aceite, el motor no quede sin lubricación y se ocasionen daños en este.

	Aceite		Combustible					Aire		Cabina
	Ecológicos	Spin On	Ecológicos	Diesel DLF	In Line	Diesel Módulo	Spin On	Cilíndrico	Panel	Panel
Atemperado del motor	1	1								
Vaciado del aceite del cárter	2	2								
Limpieza y aspirado de la base de montaje							1	1	1	
Sustitución de elementos de sellado	3		1							
Lubricación de juntas y retenes	4	3	2				1			
Correcto posicionado del elemento filtrante	5		3					2	2	2
Cebado de filtros		4					2			
Asegurado de correcta entrada de rosca		5					3			
Apretado Adecuado		6					4			
Correcto asegurado de conexiones				1	1	1				
Alimentación de circuitos					2					
Cerrado de carcasas o cartuchos	6		4				3	3	3	
Purgado de Aire			5	2		2	5			
Inspección de fugas	7	7	6	3	3	3	6			



### Asegurado de correcta entrada de rosca



Asegúrese de que los filtros tipo "Spin On" estén alineados con su base de montaje en el acoplamiento, no debería ofrecer resistencia, ya que esto significaría que no se ha realizado un acoplamiento correcto.



### Apretado adecuado



El apretado de los filtros tipo "Spin On" debe de ser el adecuado, el grado de apretamiento viene grabado sobre el filtro. Un apretado deficiente o excesivo provoca fugas o degradación del sello.



### Correcto asegurado de conexiones

Especialmente en filtros con multitud de conexiones, es fundamental asegurar un correcto montaje, considerando el tipo de acoplamiento en cada caso y revisando la sujeción de estos después del montaje.

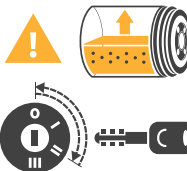

### Alimentación de circuitos

Especialmente en filtros de combustible gasolina, se recomienda previo al arranque del vehículo, cebar el sistema mediante el accionamiento del contacto sin arrancar durante 4-5 segundos.

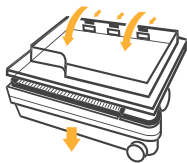

### Cerrado de carcasas o cartuchos

El montaje de toda clase de bases que contienen elementos de filtración, debe realizarse actuando sobre todos sus elementos de unión, ejecutando el grado de apriete recomendado por el fabricante.

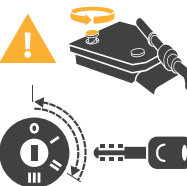

### Purgado de aire

Especialmente en filtros de combustible diésel, después del montaje y antes de arrancar el vehículo, es fundamental una exhaustiva purga de aire, no hacer esto puede ocasionar un incorrecto funcionamiento.

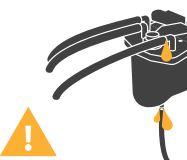

### Inspección de fugas

Especialmente en filtros de aceite o combustible, una vez sustituidos y luego de haber arrancado el motor e incluso de realizar algún trayecto, se recomienda revisar las uniones buscando fugas que pueden ocasionar averías.

## Landing page

Hemos mejorado la página principal del catálogo online. Seguimos dando prioridad a la búsqueda de productos, pero ofrecemos más información en la parte inferior de la página. Descubre los nuevos productos, o descarga directamente el catálogo en PDF.

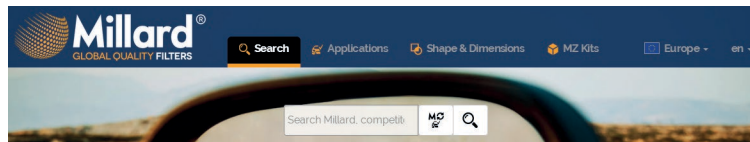

### Kits MZ

Todo para tu coche en un solo pack.



### Nuevos Productos

Descubre aquí nuestros nuevos productos.

### Filtros MC

¿Sabes los beneficios de cambiar tu filtro de cabina?

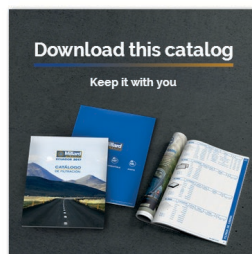
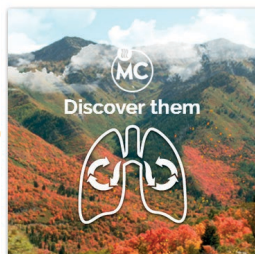

### Catálogos Descargables

El catálogo de tu país a un click.

## Búsqueda más potente

Hemos aumentado la potencia y la usabilidad de la misma.

Cuando realice una búsqueda, se mostrará un desplegable con posibles resultados.

Una primera sección con las referencias Millard que concuerden con su búsqueda, una segunda sección con las referencias de competidores, y su equivalencia en Millard.

Una tercera sección con los vehículos que concuerden con la búsqueda realizada.

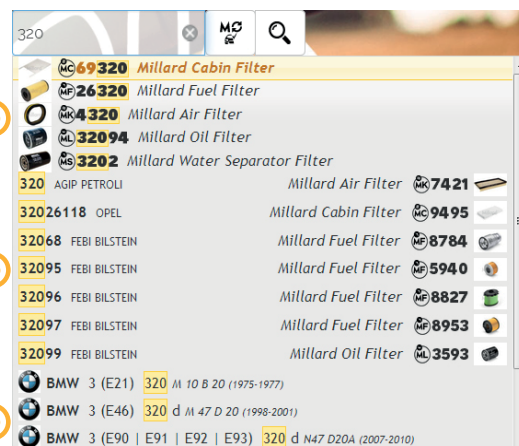

### Referencias Millard

### Referencias de Competidor

### Aplicaciones

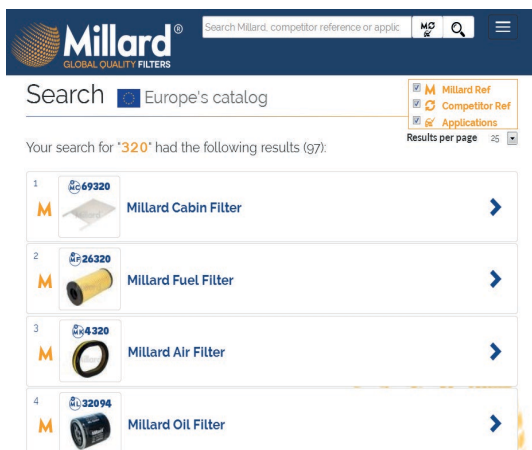

Si lo desea, puede modificar este comportamiento a través del botón de opciones ubicado inmediatamente a la derecha de la caja de búsqueda y elegir qué resultados quiere consultar.

Si en la caja de búsqueda, en vez de Enter hace click en el sistema le redirigirá a una página de resultados más extensa en función de lo escrito en la caja de búsqueda.

En esta página de resultados, podrá filtrar por tipo de resultado modificando los parámetros de la esquina superior derecha (Productos Millard, competidores o aplicaciones). Según el número de resultados obtenido, es posible que los resultados se organicen en varias páginas.

En la parte inferior de la página encontrará la barra para navegar a través de todas las páginas de resultados.

Si pulsa sobre uno de los resultados, accederá al detalle de los mismos, bien sea un producto Millard o una aplicación.

## Sección de aplicaciones

Hemos dotado también de una mayor funcionalidad a la sección de búsqueda por aplicaciones. Ahora, en los desplegables de marcas, series o modelos, puede utilizar la caja de filtrado para encontrar rápidamente la aplicación buscada.

### Applications Europe's catalog

#### Manufacturer

Select a manufacturer.

Choose a manufacturer

Choose a manufacturer

- AUDI
- BMW
- CITROEN
- FIAT
- FORD

#### Model Series

Select the model series you are looking for.

Choose the model Series

Choose the model Series

- A-Serie [1973 - 1983]
- B-MAX [2012 - 1]
- Bantam [2001 - 2006]
- C-Max [2007 - 2010]

#### Model

Select the model you are looking for.

Choose the model

Choose the model

- 1.0 EcoBoost
- 1.4 Duratec
- 1.5 TDCi
- 1.6 TDCi
- 1.6 Ti-VCT

### Marca

Seleccione una Marca, se abrirá el siguiente menú para elegir serie.

### Serie

En el desplegable de series, obtendrá información acerca del tipo de vehículo, ligero o pesado a través de los iconos ubicados a la derecha del modelo.

### Modelo

Una vez seleccionado el modelo, obtendrá el resultado completo de la aplicación. Pulse sobre un filtro para ver el detalle.

## Sección de búsqueda por forma y medidas

Hemos mantenido la esencia de la sección de búsqueda por medidas, mejorando la experiencia a través de unos iconos mejorados y una caja de búsqueda de medidas mucho más intuitiva.

## Shape & Dimensions

### Type of filter

Choose a type of filter.

Fuel Filter

### Shape

Select the image according to the filter shape.



### Refine search

Based on measures and tolerance

H (Height):	<input type="text" value=""/>	mm	± 5mm
OD (Outer Diameter):	<input type="text" value=""/>	mm	± 5mm
TH (Thread):	<input type="text" value=""/>		
DS (Drain Size):	<input type="text" value=""/>		
GS-ID (Gasket Inner Diameter):	<input type="text" value=""/>	mm	± 2mm
GS-OD (Gasket Outer Diameter):	<input type="text" value=""/>	mm	± 2mm

Diesel  Petrol  Dual Fuel

Filter



- Además, ahora, podrá visualizar las dimensiones de los productos sin necesidad de acceder a la ficha de producto.

**MF4549**

**H** (Height): 100 mm  
**OD** (Outer Diameter): 84 mm  
**TH** (Thread): M12x1.5  
**DS** (Drain Size): NO  
**GS-ID** (Gasket Inner Dim.): 62 mm  
**GS-OD** (Gasket Outer Dim.): 70 mm

**MF4886**

**H** (Height): 139 mm  
**OD** (Outer Diameter): 96 mm  
**TH** (Thread): M20x1.5  
**DS** (Drain Size): M36 x 1.5  
**GS-ID** (Gasket Inner Dim.): 52 mm  
**GS-OD** (Gasket Outer Dim.): 70 mm

**MF4922**

**H** (Height): 138 mm  
**OD** (Outer Diameter): 93 mm  
**TH** (Thread): 3/4"-16  
**DS** (Drain Size): M36 x 1.5-6H  
**GS-ID** (Gasket Inner Dim.): 56 mm  
**GS-OD** (Gasket Outer Dim.): 64 mm

## Ficha de producto

- Mejor visibilidad del producto.
- Podrá emitir un comentario sobre el artículo, y valorarlo.
- Podrá compartir la URL de producto con otra persona, enviándoselo mediante email, o bien a través de Twitter, Facebook, Google+ o LinkedIn
- Podrá descargar la ficha de producto en PDF (Atención: El catálogo de Millard es actualizado varias veces a la semana, por lo que las fichas de producto pueden quedar obsoletas en poco tiempo)

**MK 29523** Millard Air Filter

Comments Share Datasheet



<b>EAN 13</b> 5055148213015	
H (Height)	208 mm
OD (Outer Diameter)	167 mm
ID (Inner Diameter)	70 mm



**MK 29523** Applications

Available in following catalogs:

Europe Catalog Applications

Europe

Paraguay

Manufacturer	Series	Model	Engine	Kw	HP	CV	Start	Finish
FORD	C-MAX	1.6	DURATEC	74	99	101	2007	2010
FORD	C-MAX	1.6 TDCI	DURATORQ	66	89	90	2007	2010
FORD	C-MAX	1.6 TDCI	DURATORQ	74	99	101	2007	2010
FORD	C-MAX	1.6 TDCI	DURATORQ	80	107	109	2007	2010
FORD	C-MAX	1.8 16V 1.8 FLEXFUEL	DURATEC	92	123	125	2007	2010
FORD	C-MAX	1.8 TDCI	DURATORQ	85	114	115	2007	2010
FORD	C-MAX	2.0 TDCI	DURATORQ	81	109	110	2007	2010
FORD	C-MAX	2.0 TDCI	DURATORQ	98	131	133	2007	2010
FORD	C-MAX	2.0 TDCI	DURATORQ	100	134	136	2007	2010
FORD	C-MAX	2.0 2.0 BI-FUEL CNG	DURATEC	107	143	145	2007	2010
FORD	C-MAX II GRAND C-MAX	1.0 ECOBOOST	10FDOX	74	99	101	2012	-
FORD	C-MAX II GRAND C-MAX	1.0 ECOBOOST	C10FDOX	82	123	125	2012	-
FORD	C-MAX II GRAND C-MAX	1.5 ECOBOOST	-	110	148	149	2015	-
FORD	C-MAX II GRAND C-MAX	1.5 ECOBOOST	-	134	180	182	2015	-
FORD	C-MAX II GRAND C-MAX	1.5 TDCI	15DSOX	70	94	95	2015	-
FORD	C-MAX II GRAND C-MAX	1.5 TDCI	15DSOX	77	103	105	2015	-

Bajo la ficha de producto accederá a las aplicaciones de su mercado.

Dispone de una caja de búsqueda para filtrar sobre esos mismos resultados, buscando por cualquier campo que sea filtrable (marca, modelo, motor, potencia, año...)

Si pulsa sobre una aplicación, se le redirigirá al detalle de la misma, con todos los ítems para los que aplique.

## MZ Kits Europe's catalog

**MZ216**



- CITROEN
- FIAT
- GRUUA MICROBUS
- LANCIA (LANCIA
- AUTOBIANCHI)
- PEUGEOT

Models ▾ ▲

**MZ293**



- OPEL
- VAUXHALL
- VAUXHALL-BEDFORD (LCV)

Models ▾ ▲

## Sección MZ

Mejoramos la identificación de los MZ, mostrando las marcas para las que aplica el Kit.

Pulsando sobre el kit, accederá a la ficha extendida del MZ, obteniendo información sobre su composición y aplicaciones.

## Búsqueda desde la página web

Para mejorar la experiencia de usuario, hemos incorporado una caja de búsqueda directa en nuestra página web (www.millardfilters.com).

Esta se encuentra en el margen derecho, y desplegándola, podrás hacer una búsqueda directa en nuestro catálogo online.

El resultado de la búsqueda sería lo mostrado a continuación:









**CABINA**



**AIRE**



**COMBUSTIBLE**



**ACEITE**